



The 'Marine Operations' packages are produced by CCFB Marine Operations Group (MOG) and are as follows

Part 1...Safe Working On Or Near Water...*

Part 2...Offshore Incidents ~The Legal Framework

Part 3...Offshore Incidents ~Command and Control

Part 4...Helicopter Operations ~ SOP

Part 5...Tactical Ship Firefighting

Part 6...Ship construction.

Part 7...Sea Survival

Part 8...Small Boat Fire Safety

Other reference points include:-

ICS.ppt

Fire Service Manuals ~ Command and Control / Marine Operations...

DCOL's...

BIS Doc's...

Case Studies e.g 'Scandinavian Star'

CACFOA South West ICS packages

***CACFOA SW 'Safe Working On Or Near Water' (January 2001)**

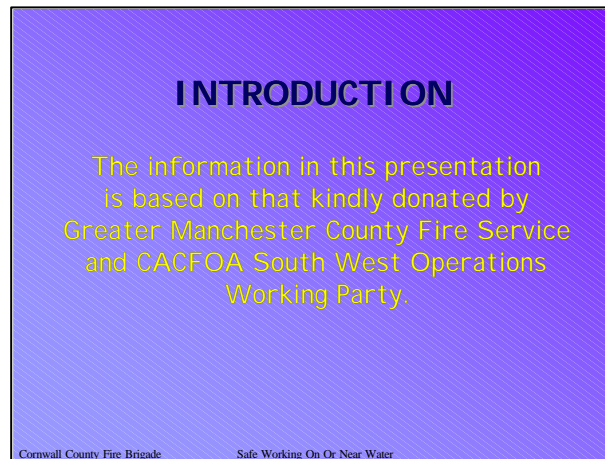

The information in this presentation is based on that originally supplied to CCFB by DF&RS and GMCFS .

The information has been extended in line with the risks associated with CCFB and it's coastline.

BACKGROUND

- ❖ POLICY..BIS..
- ❖ NO STATUTORY DUTY..
- ❖ BRIGADE WILL RESPOND..
- ❖ PREPARE ITSELF TO RESPOND..
- ❖ SMALL PERCENTAGE OF CALLS..

Cornwall County Fire Brigade Safe Working On Or Near Water

See BIS....

The Brigade has no statutory duty to attend water incidents but because there is no other rapid response service available the Brigade will normally respond.

The Brigade is preparing itself to make an effective response to what is a very hostile operational environment.

Because of the relatively small percentage of calls , which due to continuing changes in global environmental conditions are expected to increase, the training and equipment will not be disproportionate to other operational / training needs.

To be able to achieve that response the Brigade therefore must provide a suitable, risk assessed approach, proper equipment and training.

RISK ASSESSMENT

- ❖ TYPES OF WATER...
- ❖ WATER INCIDENTS PRESENT SERIOUS RISK TO FIREFIGHTERS...
- ❖ PRIMARY APPROACH TO UTILISE QSV...

Cornwall County Fire Brigade Safe Working On Or Near Water

Still water:- reservoirs ~ ponds ~ lakes ~ quarries ~ swimming pools.
Flowing water:-rivers ~ estuaries ~tidal areas ~ floodings

As recent history clearly identifies water incidents do present a serious risk to untrained and ill equipped firefighters.

In all instances the safety and welfare of Brigade personnel is of paramount importance.

IC's must ensure that all elements of Command and Control are followed.

A risk assessment is to be undertaken prior to setting priorities and allocating tasks.

Where the rescue of animals is involved, undue risk to human life should not be taken.

Risk must be proportional to benefit at all times.

CCFB GRA's.....indicate details re water related incidents.

EQUIPMENT

Equipment provided to deal with 'water related' incidents will be primarily as follows:-

- ❖ Level 1 > all 'front line' appliances will carry specific 'water safety equipment packs'...
- ❖ Level 2 > OSV's will carry more specialised equipment.

**LEVEL 1 APPLIANCE
EQUIPMENT PACKS**

- ❖ Lifejackets (4)...
- ❖ Throwing line (2)...
- ❖ Safety knife (4)...
- ❖ Snaplights:...
- ❖ Drysuit (2)...
- ❖ Thermal liners (4)...
- ❖ Loud Hailer (1)...
- ❖ Hose Inflation Kit (1)...
- ❖ Rescue Pack (line's and harness).



Cornwall County Fire Brigade Safe Working On Or Near Water

All WRI's that require an initial attendance of either a Supervisory Officer and/or crew with knowledge, basic training, limited PPE, safe working practices and procedures covered in this document.



Life jackets:- Crewsaver air foam type / 150N buoyancy inflated 40 lbs..

approx.. 90 Newton's buoyancy built in 20 lbs.. Primarily for use by non-swimmers and pump operators working near water.. Not designed for rescue purpose.

Throw Bag:- 25 metre floating line 1000 kg breaking strain.

3 methods of throwing i.e underarm ~ sidearm ~ overhead

Should be done from firm ground ~ hold on ~ stand on end, hold by bag and shout "line"!, Maintain eye contact throw to land at or across victim, May need second person to stabilise thrower or for thrower to be tied to a restricting line.

Must not under any circumstances wrap end of line round hand or other part of body

Rescue Line and harness:-

'Rocket' line:-

Welfare packs:-



The boat is a 3.6m semi rigid inflatable with a 15hp outboard engine. With the boat will be :-*throw lines, portable floodlight come torch, 'Jasons Cradle'. Rocket line.*



Inflatable path's (2) ~ 10m X 1m (can be linked together) and used on ice, mud and unstable surfaces ~ water possible but not recommended

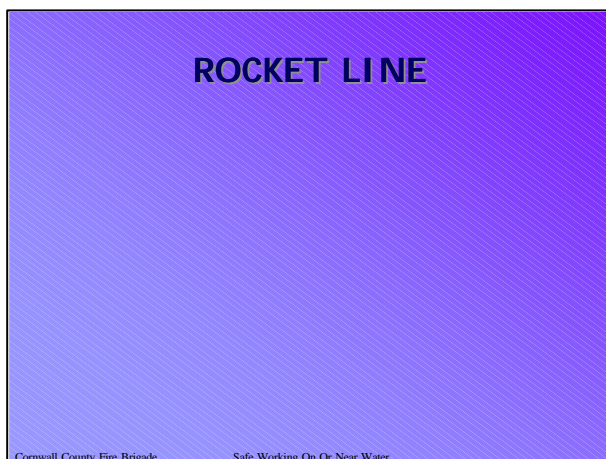

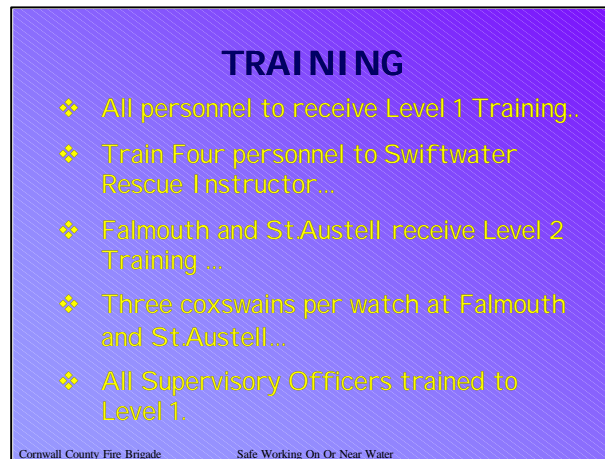

TRAINING

- ❖ All personnel to receive Level 1 Training..
- ❖ Train Four personnel to Swiftwater Rescue Instructor...
- ❖ Falmouth and St.Austell receive Level 2 Training ...
- ❖ Three coxswains per watch at Falmouth and St.Austell...
- ❖ All Supervisory Officers trained to Level 1.

Cornwall County Fire Brigade Safe Working On Or Near Water

All Brigade personnel will receive a minimum of two hours training.

Although the aim is to train all operational personnel in basic water safety procedures, enhanced training will be giving to those personnel on stations that staff the Operational Support Vehicles (OSV's)

MOBILISING
..no known immediate threat to life

- ❖ Wholetime officer..
- ❖ Nearest major pumping appliance

Cornwall County Fire Brigade Safe Working On Or Near Water

For all 'flooding' incidents , a w/t officer will normally respond initially to assess the situation

MOBILISING
..persons reported...

- ❖ Wholetime officer...
- ❖ Nearest two major pumping appliance's...
- ❖ OSV...
- ❖ Ambulance...
- ❖ Advise RAF Kinloss.

Cornwall County Fire Brigade Safe Working On Or Near Water



The IC may be faced with many difficult decisions. The greatest difficulty may be in stopping ill-conceived and reckless rescue attempts being made (where a rescuer may become a victim). Firm control must be exercised to ensure that unauthorised personnel do not venture into the water.

The appropriate level of Incident Command must be implemented (see Incident Command System BIS).

The IC should consider other specialist assistance i.e. Police Joint Underwater Search Unit (JUSU), Ambulance/Paramedics, (RSPCA), Environment Agency (EA).

When dressed in fire fighting PPE the recognised swimming method is a slow, steady breaststroke.

In situations where it has been determined that a swimming rescue will be attempted, buoyancy aids such as inflated fire hose or composite BA cylinder etc., must be used to attempt to stabilise the casualty.

A floating line and harness must be attached (over the life jacket) to the rescue swimmer.

Any attempt to rescue people or animals from waterways or associated hazards without the aid of specialist PPE and ancillary equipment i.e. buoyancy aids, immersion suits, boats etc., should wherever possible be carried out from the safety of firm ground (bank) or a structure (bridge or jetty).

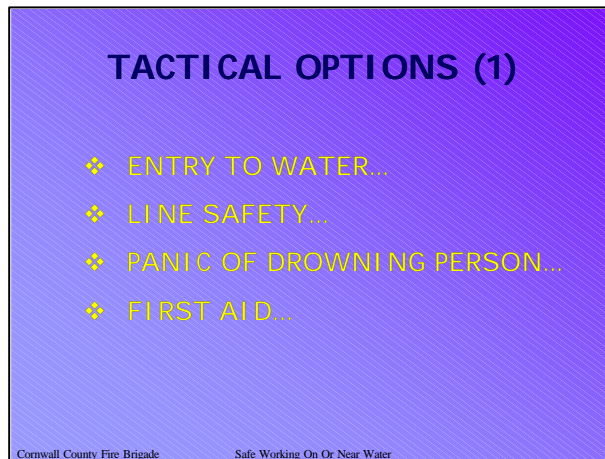

Fire fighting PPE affords mechanical and limited thermal protection and is slightly positively buoyant in water (mainly due to the air both inside the fabric/material and air pockets trapped between the material and wearer). Water entering fire boots will equalise and will not have a detrimental sinking effect.

Line Safety Officer(LSO) is responsible for :- line attached to swimmer ~ swimmers safety ~ overall control of line ~ maintain verbal contact ~ sufficient personnel to retrieve swimmer ~ initiate emergency action if communications breakdown or swimmer gets into difficulty.

Panic of a drowning person:- drawing victim cannot shout ~ a victim may attempt to climb on top of a rescuer overcoming the rescuers buoyancy and submerging them both ~ avoid direct contact ~ offer life jacket, line or floating object ~ if victim tries to grab, push away or splash water in there face ~ if contact must be made grab from behind knees into back.

First Aid:-

A drowning victim must be given CPR and continued until arrival at hospital

TACTICAL OPTIONS (2)

- ❖ WORKING NEAR WATER...
- ❖ RISK ZONE...
- ❖ RESCUE...
- ❖ RECOVERY...
- ❖ UPSTREAM, DOWNSTREAM SAFETY...
- ❖ LOW TO HIGH RISK OPTIONS.

Cornwall County Fire Brigade Safe Working On Or Near Water

Working near water the '*risk zone*' must be established i.e 3m from waters edge.

If in '*risk zone*' firefighters must wear full firefighting kit plus life jacket or restricting line. Fire helmets should be removed, or if chance of contact with debris, chin strap should be undone.

Rescue:- casualty in difficulty on surface of water or stranded or trapped in or near water

Recovery:- victim floating face down / no information on time of entry / victim subsurface for more than 10 mins

Upstream spotter:- must have good communications with personnel working on water as to debris heading towards them.

Downstream safety:- must have similar number to those working on water must have the appropriate PPE. and throw line.

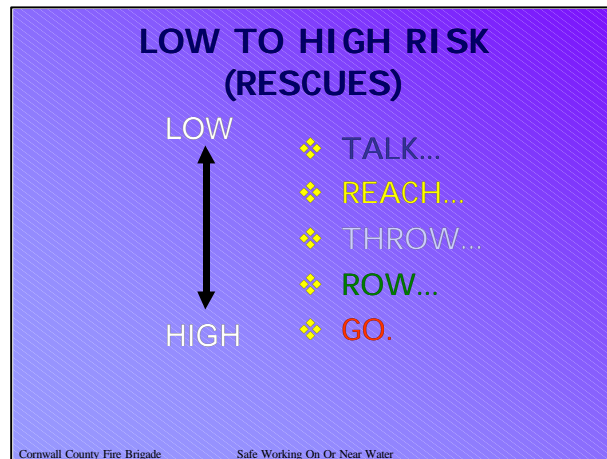

Risk assessment identifies a 'low to high risk' element when dealing with rescues involving water etc. They are ..

Talk It is important that contact is made with the casualty as quickly as possible. Keep talking to them, explain what you are going to do, what you want them to do and keep encouraging them.

Reach Either with your hand, or equipment from the appliance - e.g. ceiling hook, chimney rods, inflated fire hose pull the casualty to the bank. By lying down, you can increase the distance reached and also prevent yourself being pulled in.

Throw Use a throw line and/or rescue line. Throw one end out to the casualty.

Row OSV personnel utilising specialist equipment.

Go Only if all these fail, as a very last resort enter the water.

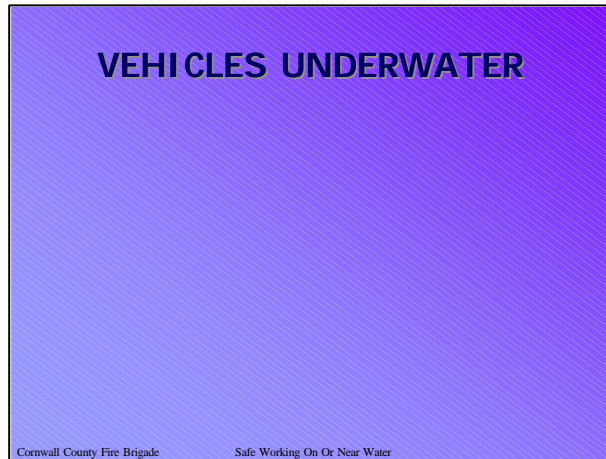

When the vehicle is close enough to the bankside, it may be possible to wade through the water or to bridge ladders or use the Inflatable Rescue Path (IRP) to gain access to, or onto it.

If the occupants of the vehicle have managed to self rescue and position themselves on top of the vehicle it may be possible to use rescue sleds, inflated fire hose, throwing lines or a bridged ladder to stabilise or remove them.

Where the incident involves a vehicle submerged below the surface of the water and it is determined from a reliable source (Police or witness) that the vehicle has been in the water for a considerable time (in excess of 15 minutes), the Incident Commander should await the arrival of the OSV to examine the vehicle and should not commit personnel prior to its arrival.

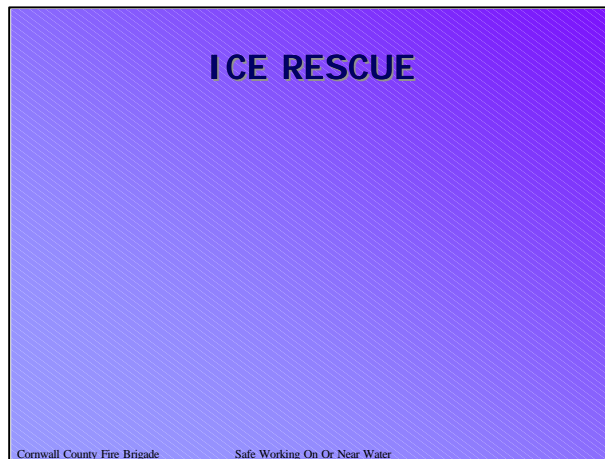

Rescues from ice can fall into three basic categories:-

- Where the casualty has fallen through the ice and requires removal.
- Where the casualty is apparently injured and lying on the surface of the ice and requires removal.
- Where the casualty is stranded on an island or in a vessel surrounded by ice.

In addition to all the points raised under “Water Rescues”, the following points should also be considered:-

- The thickness of ice.
- The state of the water below ice.

Safety of Personnel

Adhere to the guidance as for “Water Rescues”, in addition:-

- Personnel venturing onto the ice should spread their weight over as large an area as possible. The use of rescue sleds, ladders and salvage sheets should be considered.

If it is necessary to enter the water, a path should be broken and maintained. If there is a need to cut, chip or hammer the ice for any reason, then eye protection must be worn.



The principle obstacle to access is the soft surface which may make walking impossible. The basis of effective access across mud is to spread the weight of the body as widely as possible.

- The route taken by the casualty may not be the best access route for recovery. Time spent on reconnaissance is never wasted. The IC should consider the most effective route, the position of a safe working area on firm ground and whether additional equipment including lighting will be required to complete the rescue.

- It may be pertinent to provide the casualty with BA where the potential exists for the casualty to become submerged, either in the substance or any tidal effect

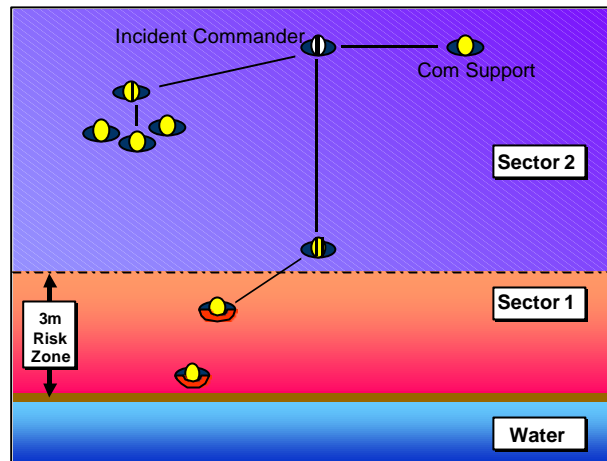

As previous slide notes...

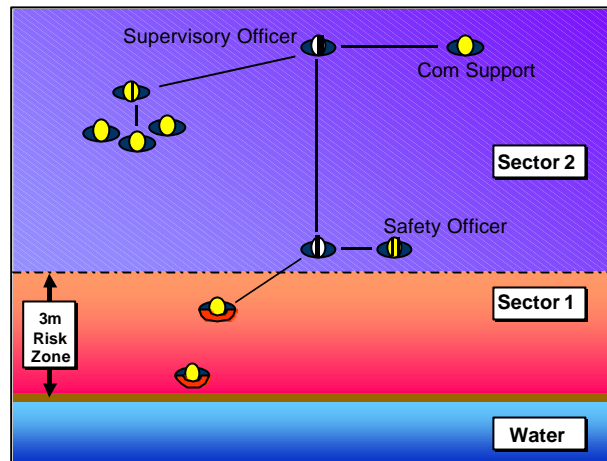

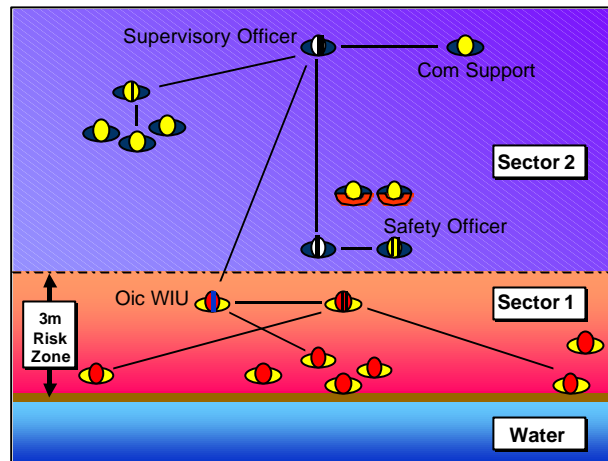

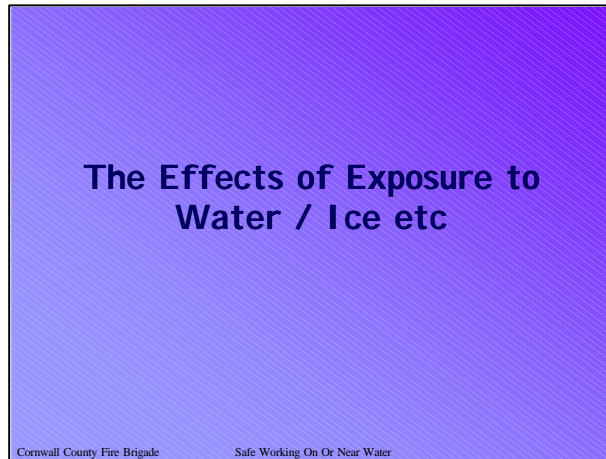

The effects of unprepared exposure to water, ice etc can be fatal. This does not need to be prolonged exposure as everybody's metabolism acts differently dependent on age, fitness physical and mental attitude..the 'will to survive' is built on andrenilin!!!!

The diseases most likely to be encountered are Hepatitis A, Gastro-enteritis and Weil's Disease caused by a variety of bacteria and virus.

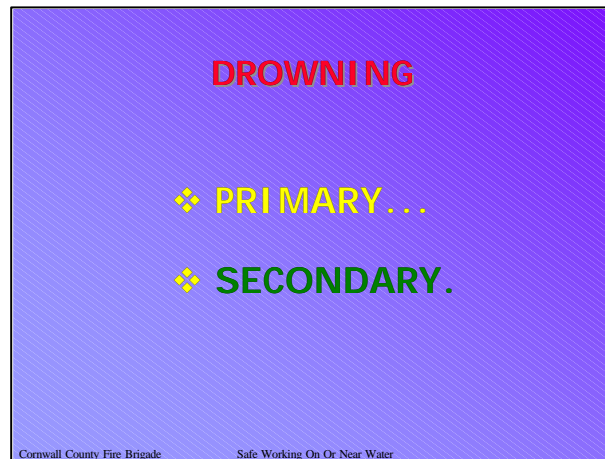

Definition :- water interfering fatally with respiration

Two types:- primary i.e drowning at scene

dry i.e no water in lungs

wet i.e - water in lungs

secondary- dying from complications up to 72 hours

later

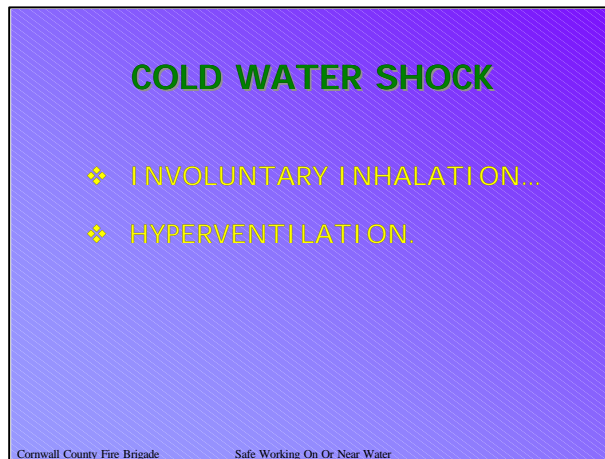

You may be familiar with the reaction experienced with sudden cold water contact 'gasp'!!.....the sudden gasp is involuntary and is due to the body's demand for oxygen.

If this occurs with the face in or near the water, water will be inhaled triggering the drowning sequence.

Holding your breath is impossible...the body's demand for oxygen causes hyperventilation short gasps in and out (panting) again at this stage water can be inhaled triggering drowning.

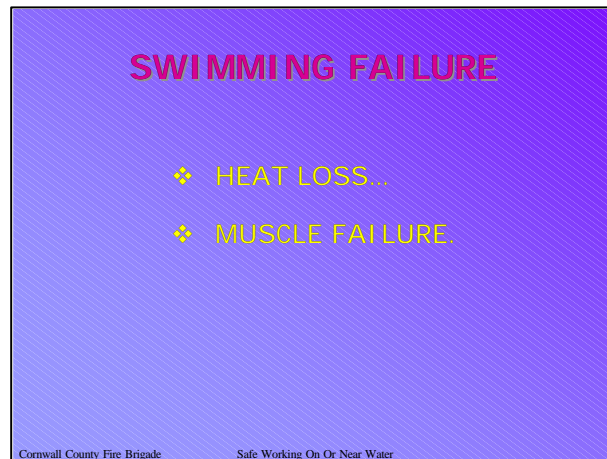

The body loses heat 25 to 30 times faster in water than in air of the same temperature...flowing water can multiply this by ten fold.

Rapid cooling causes the muscles to stiffen, the blood thickens thus causing brain function to be slower.

Blood is diverted from the extremities to the core, starving the limbs of oxygen and heat

Swimming co-ordination becomes impaired eventually the victim is unable to keep themselves on the surface... drowning can occur within 2 to 15 mins.

A strong swimmer can be reduced to that of a non swimmer within seconds... and panic and over exertion can cause cardiac arrest in unfit people.

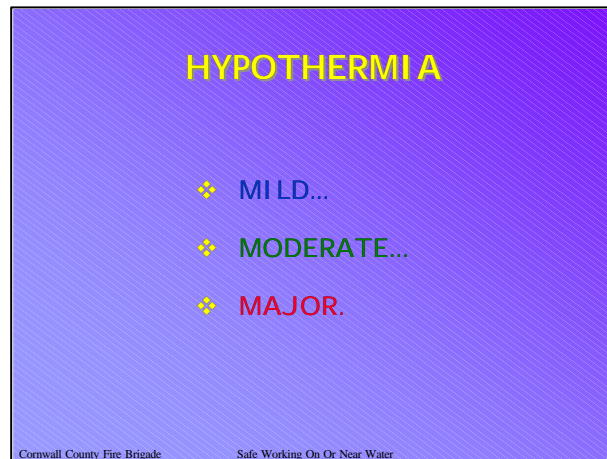

Beware of hypothermia. Symptoms are shivering, slurred speech, lack of co-ordination and cold to the touch. If there is any doubt, seek medical attention. Remember, shivering ceases in the more advanced stages of hypothermia and so the lack of such shivering in isolation cannot be relied upon as to the welfare of the individual.

Reduction of body temperature

Mild:- shivering, slurred speech, lack of co-ordination, cold to touch.

Moderate:- shivering stops, pulse and respiration slow, semi-conscious state occurs.

Major:- unconsciousness, looks dead, heart failure...death can occur within 15 to 30 mins.

SURVIVAL TIMES		
EFFECT	SURVIVAL TIME	OUTCOME

Cornwall County Fire Brigade Safe Working On Or Near Water

The following information has been provided by the Institute of Naval Medicine, Portsmouth.

Survival times of people on the surface of the water, maximum water temperature of 15 (c (59(f) can be categorised as follows:-

N.B. Wearing a life jacket will not stop the above effects.

Cold water immersion cools the body 27 times faster than static dry air temperature, this is multiplied by a further factor of 10 when swimming.

In cold water a good strong, swimmer will quickly reduce to a non swimmer because of the effects of immersion hypothermia. Summer inland water temperatures are known to average between 10⁰ and 15⁰C.

SURVIVAL TIMES		
EFFECT	SURVIVAL TIME	OUTCOME
COLD SHOCK	2-3 MINS	DROWNING

Cornwall County Fire Brigade Safe Working On Or Near Water

SURVIVAL TIMES		
EFFECT	SURVIVAL TIME	OUTCOME
COLD SHOCK	2-3 MINS	DROWNING
SWIMMING FAILURE	3-15 MINS	DROWNING

Cornwall County Fire Brigade Safe Working On Or Near Water

SURVIVAL TIMES		
EFFECT	SURVIVAL TIME	OUTCOME
COLD SHOCK	2-3 MINS	DROWNING
SWIMMING FAILURE	3-15 MINS	DROWNING
HYPOTHERMIA	15-30 MINS	DEATH

Cornwall County Fire Brigade Safe Working On Or Near Water

POST IMMERSION CARE...

- ❖ Airway...
- ❖ Warming...
- ❖ Clothing...
- ❖ Welfare...
- ❖ Medical advice.

Cornwall County Fire Brigade Safe Working On Or Near Water

All personnel who have been immersed in cold water should be taken to a warm environment as soon as possible. Fire Brigade personnel should be removed from operational duties, until they are thoroughly warmed, have dry clothing and their welfare has been suitably addressed.

Non Fire Brigade personnel, who are either casualties or rescuers, should be advised to seek medical advice. Any person who has been revived or was near to drowning should be conveyed to hospital. Secondary drowning can take place up to 72 hours later.



Personal hygiene is important where crews have been in contact with open water, mud or similar. All personnel must wash and shower as soon as is practically possible after the incident and all equipment should be cleaned, tested and serviced in accordance with the periodic maintenance schedule.

A HAZMATO may be mobilised to deal with decontam. etc

A de-brief of incident should be undertaken to determine if there are any significant findings in relation to:-

- Personal injury or trauma.
- Procedures.
- Equipment.
- Training.
- Inter Service liaison.
- Risk Assessment and safety systems.

Remember, exposure may have 'RIDDOR' implications.

SUMMARY

- ❖ Types of Incidents...
- ❖ Equipment..
- ❖ Training...
- ❖ ICS...
- ❖ Welfare...
- ❖ Post Incident.

Cornwall County Fire Brigade Safe Working On Or Near Water

CORNWALL COUNTY FIRE BRIGADE

~ Marine Operations Group ~

Marine Operations ~ Part 1

'Safe Working On or Near Water'

INTRODUCTION

The information in this presentation is based on that kindly donated by Greater Manchester County Fire Service and CACFOA South West Operations Working Party.

BACKGROUND

- ❖ POLICY..BIS..
- ❖ NO STATUTORY DUTY...
- ❖ BRIGADE WILL RESPOND...
- ❖ PREPARE ITSELF TO RESPOND...
- ❖ SMALL PERCENTAGE OF CALLS...

RISK ASSESSMENT

- ❖ TYPES OF WATER...
- ❖ WATER INCIDENTS PRESENT SERIOUS RISK TO FIREFIGHTERS...
- ❖ PRIMARY APPROACH TO UTILISE OSV...

EQUIPMENT

Equipment provided to deal with 'water related' incidents will be primarily as follows:-

- ❖ Level 1 > all 'front line' appliances will carry specific 'water safety equipment packs'...
- ❖ Level 2 > OSV's will carry more specialised equipment.

LEVEL 1 APPLIANCE EQUIPMENT PACKS

- ❖ Lifejackets (4)...
- ❖ Throwing line (2)...
- ❖ Safety knife (4)...
- ❖ 'Snaplights'...
- ❖ Drysuit (2)...
- ❖ Thermal liners (4)...
- ❖ Loud Hailer (1)...
- ❖ Hose Inflation Kit (1)...
- ❖ Rescue Pack (line's and harness).



LEVEL 2 OSV EQUIPMENT

- ❖ LIFE JACKETS...
- ❖ THROW LINES...
- ❖ RESCUE LINES...
- ❖ ROCKET LINES...
- ❖ WELFARE PACKS.
- ❖ STRETCHER
- ❖ MUD LANCE
- ❖ RESCUE PACK
- ❖ BOAT
- ❖ IRP
- ❖ HOSE INFLATORS
- ❖ HELMETS
- ❖ DRY SUITS
- ❖ THERMAL LINERS
- ❖ 'JASONS CRADLE'

OSV ~ SAFETY BOAT



OSV ~ INFLATABLE RESCUE PATH (IRP)



ROCKET LINE

TRAINING

- ❖ All personnel to receive Level 1 Training..
- ❖ Train Four personnel to Swiftwater Rescue Instructor...
- ❖ Falmouth and St.Austell receive Level 2 Training ...
- ❖ Three coxswains per watch at Falmouth and St.Austell...
- ❖ All Supervisory Officers trained to Level 1.

MOBILISING

..no known immediate threat to life

- ❖ Wholetime officer...
- ❖ Nearest major pumping appliance

MOBILISING

..persons reported...

- ❖ Wholetime officer...
- ❖ Nearest two major pumping appliance's...
- ❖ OSV...
- ❖ Ambulance...
- ❖ Advise RAF Kinloss.

COMMAND AND CONTROL ~ TACTICAL OPTIONS

- ❖ DO NOT ENTER THE WATER!!!...
- ❖ REMEMBER...Talk.. Reach..Throw..
Row.. 'GO'...

TACTICAL OPTIONS (1)

- ❖ ENTRY TO WATER...
- ❖ LINE SAFETY...
- ❖ PANIC OF DROWNING PERSON...
- ❖ FIRST AID...

TACTICAL OPTIONS (2)

- ❖ WORKING NEAR WATER...
- ❖ RISK ZONE...
- ❖ RESCUE...
- ❖ RECOVERY...
- ❖ UPSTREAM, DOWNSTREAM SAFETY...
- ❖ LOW TO HIGH RISK OPTIONS.

LOW TO HIGH RISK (RESCUES)

LOW



HIGH

- ❖ TALK...
- ❖ REACH...
- ❖ THROW...
- ❖ ROW...
- ❖ GO.

VEHICLES UNDERWATER

ICE RESCUE

MUD & SAND

Incident Commander

Com Support

Sector 2

Sector 1

Water

3m
Risk
Zone

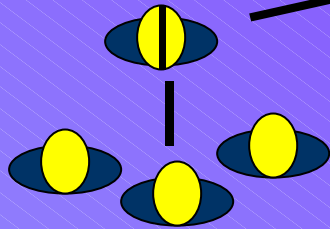

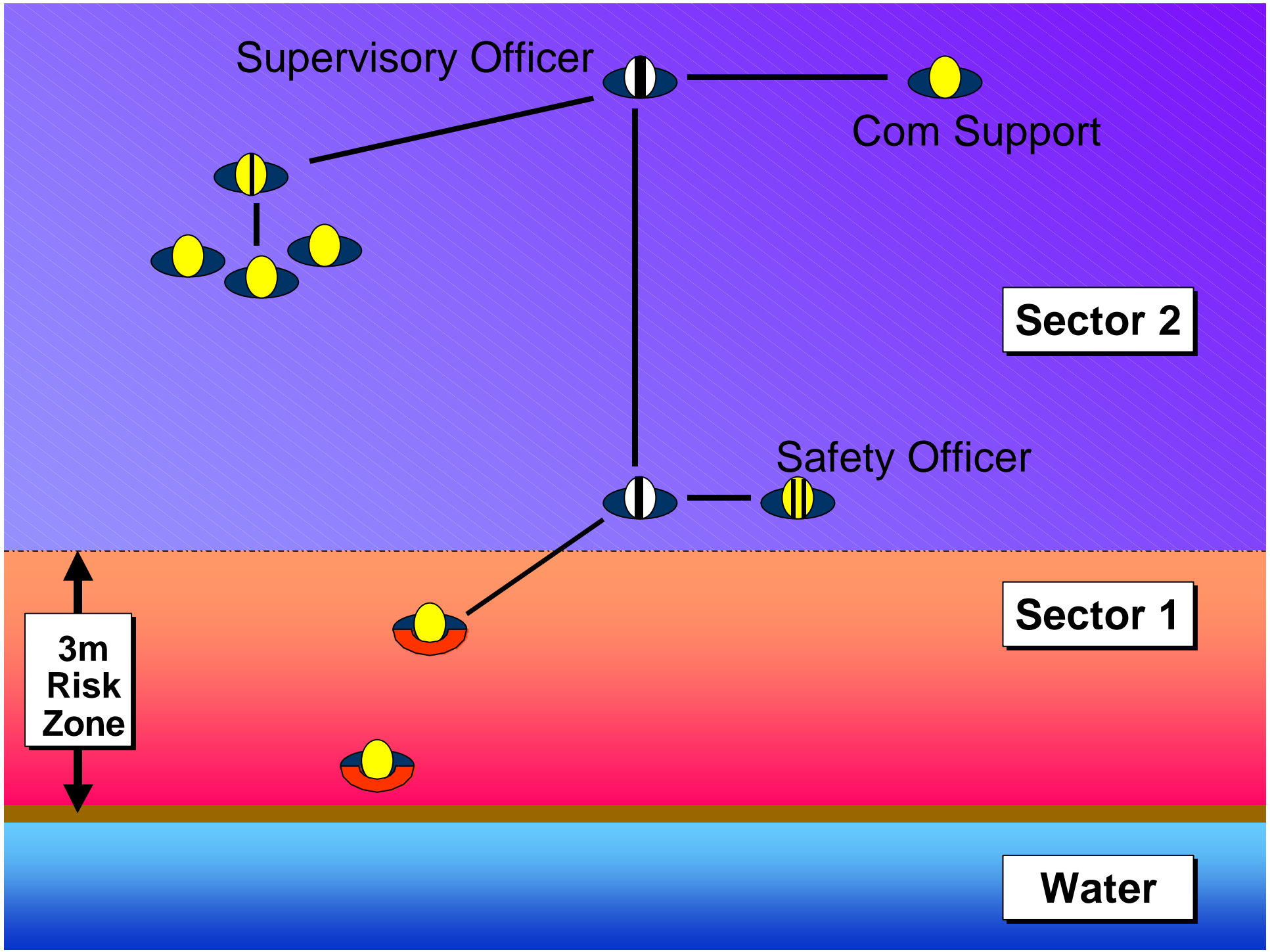

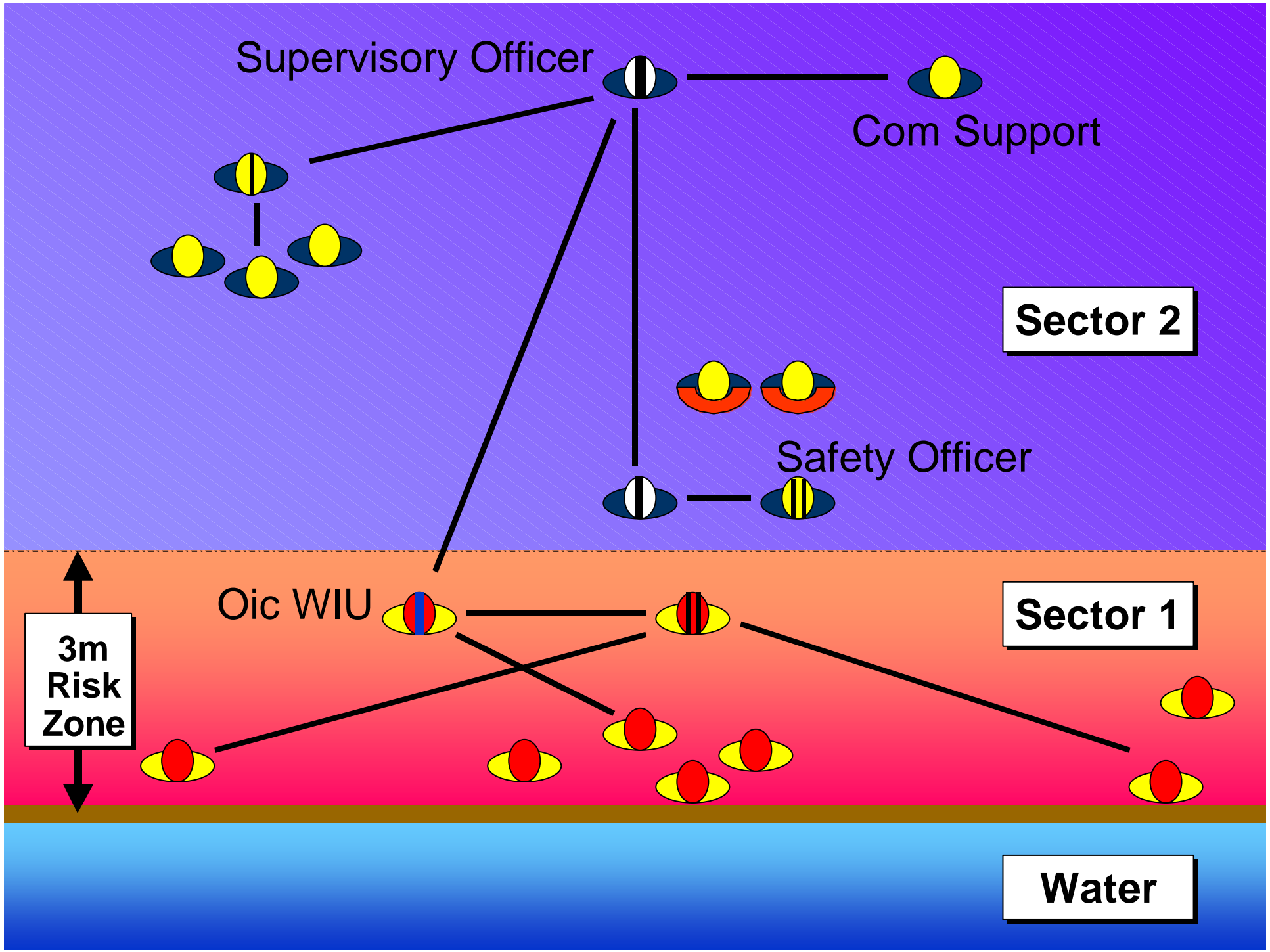

Supervisory Officer

Com Support

Sector 2

Safety Officer

Oic WIU

Sector 1

3m Risk Zone

Water

The Effects of Exposure to Water / Ice etc

DROWNING

❖ **PRIMARY...**

❖ **SECONDARY.**

COLD WATER SHOCK

- ❖ INVOLUNTARY INHALATION...
- ❖ HYPERVENTILATION.

SWIMMING FAILURE

- ❖ HEAT LOSS...
- ❖ MUSCLE FAILURE.

HYPOTHERMIA

❖ MILD...

❖ MODERATE...

❖ MAJOR.

SURVIVAL TIMES

EFFECT	SURVIVAL TIME	OUTCOME

SURVIVAL TIMES

EFFECT	SURVIVAL TIME	OUTCOME
COLD SHOCK	2-3 MINS	DROWNING

SURVIVAL TIMES

EFFECT	SURVIVAL TIME	OUTCOME
COLD SHOCK	2-3 MINS	DROWNING
SWIMMING FAILURE	3-15 MINS	DROWNING

SURVIVAL TIMES

EFFECT	SURVIVAL TIME	OUTCOME
COLD SHOCK	2-3 MINS	DROWNING
SWIMMING FAILURE	3-15 MINS	DROWNING
HYPOTHERMIA	15-30 MINS	DEATH

POST IMMERSION CARE...

- ❖ Airway...
- ❖ Warming...
- ❖ Clothing...
- ❖ Welfare...
- ❖ Medical advice.

POST INCIDENT

- ❖ Hygiene...
- ❖ Decontamination...
- ❖ Service and test equipment...
- ❖ Debrief and report...
- ❖ HAZMAT procedure.

SUMMARY

- ❖ Types of incidents...
- ❖ Equipment...
- ❖ Training...
- ❖ ICS...
- ❖ Welfare...
- ❖ Post Incident.

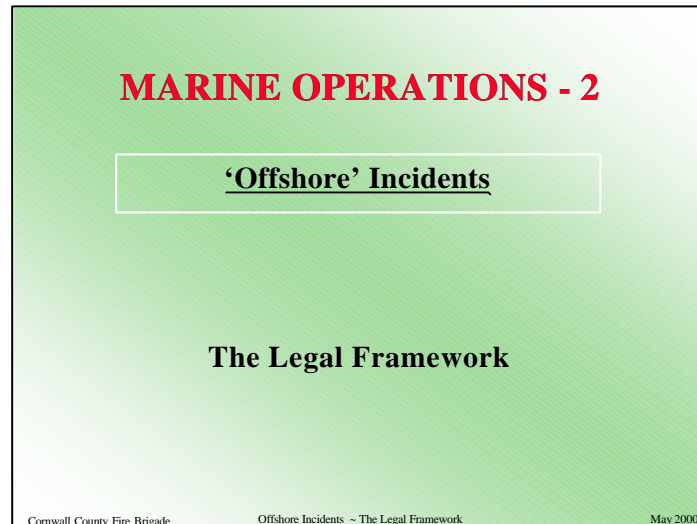

The 'Marine Operations' packages are produced by CCFB Marine Operations Group (MOG) and are as follows

Part 1...Safe Working On Or Near Water...

Part 2...Offshore Incidents ~The Legal Framework

Part 3...Offshore Incidents ~Command and Control

Part 4...Helicopter Operations ~ SOP

Part 5...Tactical Ship Firefighting

Part 6...Ship construction.

Part 7...Sea Survival

Part 8...Small Boat Fire Safety

Other reference points include:-

ICS.ppt

Fire Service Manuals ~ Command and Control / Marine Operations...

DCOL's...

BIS Doc's...

Case Studies e.g 'Scandinavian Star'

CACFOA South West ICS packages



This presentation originally produced by Divisional Officer Allan Kimpton, Kent Fire Brigade has been amended by Divisional Officer Mervyn Kettle, Cornwall County Fire Brigade, January 2000 and some of the procedures indicated are a mix of the two brigades although the generic procedures are compatible to both organisations.

“FIRE SERVICES ACT 1947”

1. No power explicit - the local authority boundary is low water mark...
2. Section 3(i)d - Power to employ outside area...
3. Section 3(i)dd - Extends power beyond territorial limits - gives legal base for offshore work.
Removes ambiguity...

NOTE: Additional Insurance is a matter for individual Chief Fire Officers.
Competing resource priorities.
Deployment of any financial provision.

Cornwall County Fire Brigade Offshore Incidents – The Legal Framework May 2000

There is no provision in the Fire Services Act 1947 empowering the Fire Authority to employ its Fire Brigade in extinguishing fires in ships at sea. Nevertheless, the power of a Fire Authority to employ its Fire Brigade applies in relation to fires in ships in its area as it does to fires on land.

Whilst it is the duty of the Fire Authority to make provision for firefighting purposes which normally relates to the Authority's own area, there is nothing to prevent a Fire authority employing its Fire Brigade to extinguish a fire in a ship at sea outside its area. All incidents at sea below the low water mark are responded to in accordance with section 3(I)d and (dd) of the 'Fire Services Act 1947'.

The new paragraph 3 (I)(dd) of the Fire Services Act 1947 extends powers beyond territorial limits and ensures that the deployment of Fire Brigades at sea has a clear legal base within existing UK legislation but it does not extend the statutory powers of duties of the Authority. This amendment strengthens the advice within Dear Chief Officer Letter 9/1992 and removes any ambiguity over Fire Authority's discretionary powers to attend incidents at sea beyond territorial waters.



Ship fires and other emergency incidents involving ships offshore always present particular and extreme problems for the Fire Service.

Due to their location off shore incidents can often be a major life risk as they are always much more difficult to control and subdue than fires on land and create enormous command and control, logistical, and communication problems.

Some coastal Fire Brigades regard offshore firefighting operations as an integral part of the service and whilst demand for this service is not frequent, experience has shown that when it does occur the need is very real. The consequences of it not being available are too disturbing to contemplate.

Over the years there has been a huge amount of debate regarding offshore operations. A great part of this debate has centred on the legality of offshore work and the procedures that should be adopted and the interface with other agencies involved.

See Parts 3A and 4 for further details on items 2>5

STATUTORY POSITION

United Kingdom Fire Brigades are not legally bound to carry out any activity except that involving fires...this does not extend outside the Local Authority boundary.

Should a Chief Fire Officer declare the resources of the Brigade to deal with 'offshore' incidents, then this is done with the approval of the local Public Protection Committee - and at no additional cost.

OTHER KEY GUIDANCE DOCUMENTS

- Memorandum of Understanding between Coastguard Agency and the Fire Service for firefighting and chemical hazards including rescue on vessels at sea (Sept 1994)...
- Dear Chief Fire Officer Letter (DCOL) 9/92 Firefighting and Rescue at Sea...
- CACFOA Memorandum of Understanding between Coastal Fire Services on Offshore Procedures South East Region (1996).

Cornwall County Fire Brigade Offshore Incidents – The Legal Framework May 2000

DEAR CHIEF OFFICERS LETTER 9/1992 (DCOL)

This updates a previous DCOL and contains the substantive Home Office guidance in relation to firefighting in associated operations at sea. It is interesting to note that since the production of this Guidance there has been continual debate about the validity of any of its elements.

CHIEF AND ASSISTANT CHIEF FIRE OFFICERS ASSOCIATION (CACFOA) MEMORANDUM OF UNDERSTAND BETWEEN THE COASTGUARD AGENCY AND CACFOA FOR FIREFIGHTING, CHEMICAL HAZARDS AND RESCUES ON VESSELS AT SEA (SEPTEMBER 1994).

This document deals with the issues relating to offshore response and recognises the coastguard's co-ordination role along with that of the Fire Service and other Agencies.

Other documents regarding offshore operations have been produced and, in particular, the CACFOA 'Offshore Procedures between coastal Fire Brigades'. This document was produced initially for CACFOA No. 4 and 5 Districts (South East England) to create harmony for those joint users of the RAF Search and Rescue. The agreed document is to be the format for the South East Coast users which include Kent, Norfolk, Suffolk, Lincolnshire and Essex. The Ministry of Defence seem keen at the present time for the Home Office to accept the document as a National standard, albeit that it is a compromise between those involved and the Fire Brigades Union have taken a similar approach.

DECLARED FACILITIES

(CACFOA Memorandum of Understanding with Coastguard Agency, September 1994)...

1. Maintaining to declared standard...
2. Informing of changes to declared facilities...
3. Informing H.M. Coastguard of reasons for non-availability when requested...

NOTE: *The MCA is the co-ordinating Service for incidents at sea (Coastguard Act 1925).*

Cornwall County Fire Brigade Offshore Incidents - The Legal Framework May 2000

Fire Brigades declared resources to MCA for use at offshore incidents could include the following example:

Initial flight teams of personnel (airborne).

Waterborne approach teams of personnel (tug).

It always should be noted that, regardless of the mode of transport used for initial attendance be it by sea or air, arrangements are made to have a vessel standing by for safety purposes throughout the incident in case rapid evacuation is required, or a firefighter falls overboard.

Following a request for assistance, usually from the MCA who have overall responsibility in UK territorial waters, the specialist initial team of nine personnel are deployed by helicopter to carry out an assessment of any fire and can usually be on board a stricken vessel in mid channel within 45minutes of the time of call to the Brigade, speed of response being of the utmost importance, and as stated, other firefighters and safety crews can be transferred to the incident area by way of helicopter or firefighting tugs to ensure an effective attack can be then made and sustained throughout the incident.

INSURANCE

1. Local Authority Employers Liability Insurance...
2. Marine Liability Indemnity Insurance...
3. Aviation Liability Insurance...
4. Personal Accident Insurance - Incidents and Training
(Total £7.5m; Death £306,000; Temporary total or partial disablement. @ Dec.1999)...
5. Firemen's Pension Scheme...

NOTE: Fire Brigades' Union (FBU) policy £1 m per fire-fighter.

Cornwall County Fire Brigade Offshore Incidents - The Legal Framework May 2000

Brigades having taken up the responsibility for offshore operations will require additional marine liability indemnity insurance and possible aviation contingency insurance. They will also require contractual liability whilst using vessels for transporting personnel and equipment by tugs or other craft and the use of aircraft for training purposes and for transportation to incidents.

Most Fire Authorities would have employers liability insurance which covers the local authorities legal liability for injury to employees arising out of their employment with that Authority. This cover normally extends to all areas within the European boundaries.

RESPONSIBILITIES

Section 45 A(i) Merchant Shipping Act 1894:

Responsibility for the safety of a ship at sea rests with the Master / Captain and the owner.

Merchant Navy ~
Power delegated from Master to Fire Brigade as accepted practice...

Royal Navy ~
'a joint approach'.

Cornwall County Fire Brigade Offshore Incidents – The Legal Framework May 2000

Normally Brigades will ensure that assistance has been expressly requested by the Owners Agents or Master/Captain of the ship through Maritime Coastguard Agency (MCA) before they will agree to attend. The Senior Fire Officer in attendance will normally confirm upon arrival that the Brigade's assistance is still required.

This continues to be important under Section 45a of the Merchant Shipping Act 1894 which lays out the responsibility for safety of a ship at sea rests with the Master/Captain and the owner.

The Captain or Master of a ship retains overall responsibility for the safety of the ship, even when the ship is in refit or under repair. In case of fire offshore the Captain will normally be expected to transfer the responsibility for firefighting to the Senior Fire Brigade Officer present (unlike Royal Navy ships). Once a ship's Master has agreed and requested Fire Brigade assistance it would be expected that he would hand over firefighting and rescue responsibilities to the Fire and Rescue Commander on scene and therefore any further involvement of his crew would be under the sole direction of the Fire and Rescue Commander although this would be by way of liaison between a senior ship's officer and the Fire and Rescue Commander at the incident scene, in other words a partnership arrangement.

RECLAIMING COSTS ~ 'SALVAGE'

1. Lloyds forms of salvage not used (Fire Brigade could be liable for losses!)
2. Brigades are not allowed to charge 'for the purposes of fighting fire'.

(Case law: 1999. ex 'Kukawa' fire ~ Cornwall Fire Brigade 1997)...

3. 'Reasonable costs' and ex-gratia payments?

Several Brigades have now moved away from the **Lloyds Form** of salvage agreement as the Brigade could be held liable for any loss if it occurred. Under normal circumstances the Brigade would seek to cover reasonable costs by rendering an account for services provided by prior agreement with the Master or owners upon arrival at the incident. In other words, offshore incidents are treated as chargeable special services through the owners or salvors.

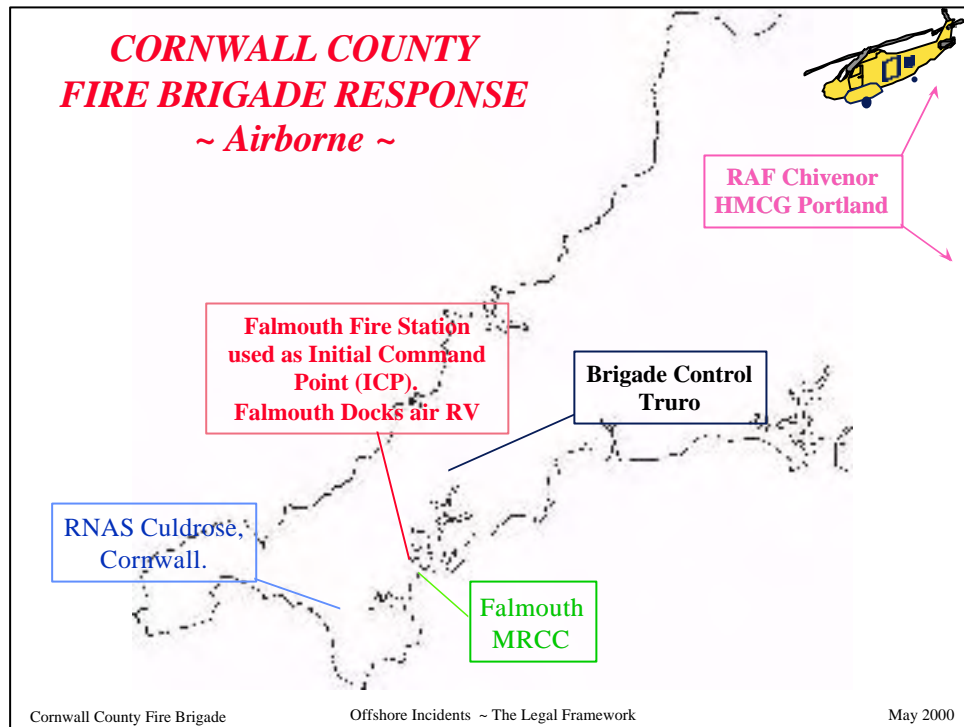

Response criteria...

- Request from MCA ...
- Request from another source that is approved and supported by the MCA...
- Must be approved by a Fire Brigade 'Principal' Officer - where there is an *immediate risk to life* or high risk of an incident developing that will have a *serious environmental impact*.

Corwall County Fire Brigade Offshore Incidents - The Legal Framework May 2000

IT IS ANTICIPATED HELICOPTER RESPONSE TEAMS ACTING IN ISOLATION CANNOT AND WILL NOT INITIATE 'OFFENSIVE' TACTICS.

The defined task will be to provide actions and make provisions for when additional resources become available.

The MCA will seek the help of the relevant Fire Service after receiving a request for Fire Service assistance from the Master of a vessel at sea. It is considered that Fire Services/Brigades may respond to calls for assistance particularly where life is at risk. The decision to attend or not will be made by the appropriate Chief Fire Officer or his/her nominated representative.

The Chief Fire Officer Firemaster or his/her representative will require specific information before committing the resources of his Fire Service. The form detailed in Section 19 should be used for this purpose. In the first instance HM Coastguard should attempt to complete those items asterisked and in bold print. This should also be faxed to the Fire Service by the co-ordinating HM Coastguard station. Subsequent information can be added when required by the Coastguard.

Teams...

'Assessment' Team:-
...team of **two** Officers only. Despatched when very limited information available...

'Strike' Team:-
...team of six, minimum. Despatched when immediate risk to life is known and / or suitable risk assessment has been achieved...

'Support' Teams:-
... as transport resources permit; to allow 'Offensive' tactics to be more suitably introduced.

Cornwall County Fire Brigade Offshore Incidents – The Legal Framework May 2000

Command and Control

See Package No. 3A

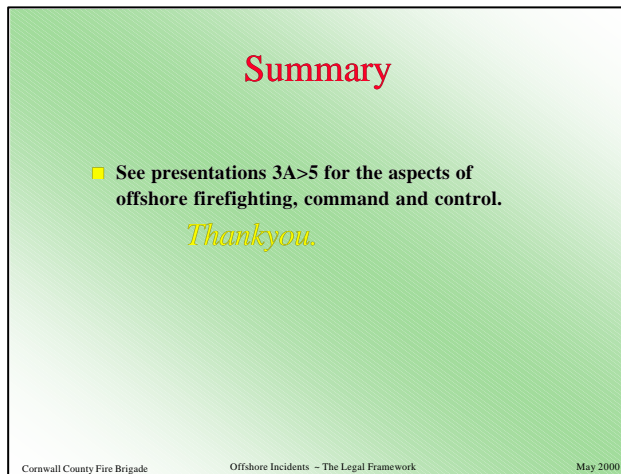

Summary

- See presentations 3A>5 for the aspects of offshore firefighting, command and control.

Thankyou.

Cornwall County Fire Brigade Offshore Incidents – The Legal Framework May 2000

MARINE OPERATIONS - 2

'Offshore' Incidents

The Legal Framework

Grateful thanks to Kent Fire Brigade for much of the original content that was used in the production of this presentation.



“FIRE SERVICES ACT 1947”

1. No power explicit - the local authority boundary is low water mark...
2. Section 3(i)d - Power to employ outside area...
3. Section 3(i)dd - Extends power beyond territorial limits - gives legal base for offshore work.
Removes ambiguity...

NOTE: Additional Insurance is a matter for individual Chief Fire Officers.
Competing resource priorities.
Deployment of any financial provision.

INTRODUCTION

CONSIDERATIONS

1. Statutory position...
2. Initial response - transport...
3. Command and Control...
4. Communication...
5. Logistics - equipment.

STATUTORY POSITION

United Kingdom Fire Brigades are not legally bound to carry out any activity except that involving fires...this does not extend outside the Local Authority boundary.

Should a Chief Fire Officer declare the resources of the Brigade to deal with 'offshore' incidents, then this is done with the approval of the local Public Protection Committee - and at no additional cost.

Known declared response...



- Cornwall
 - Mid and West Wales
 - North Wales
 - Merseyside
 - Isle of Man
 - Lancashire
 - Northern Ireland
 - Highlands and Islands
 - Humberside
 - Lincolnshire
 - Suffolk
 - Kent
 - East Sussex
 - Isle of Wight
 - Hampshire
 - Guernsey
 - Jersey
- TOTAL ... 17

OTHER KEY GUIDANCE DOCUMENTS

- Memorandum of Understanding between Coastguard Agency and the Fire Service for firefighting and chemical hazards including rescue on vessels at sea (Sept 1994)...
- Dear Chief Fire Officer Letter (DCOL) 9/92 Firefighting and Rescue at Sea...
- CACFOA Memorandum of Understanding between Coastal Fire Services on Offshore Procedures South East Region (1996).

DECLARED FACILITIES

(CACFOA Memorandum of Understanding with Coastguard Agency, September 1994)...

1. Maintaining to declared standard...
2. Informing of changes to declared facilities...
3. Informing H.M. Coastguard of reasons for non-availability when requested...

NOTE: *The MCA is the co-ordinating Service for incidents at sea (Coastguard Act 1925).*

INSURANCE

1. Local Authority Employers Liability Insurance...
2. Marine Liability Indemnity Insurance...
3. Aviation Liability Insurance...
4. Personal Accident Insurance - Incidents and Training

(Total £7.5m; Death £306,000; Temporary total or partial disablement. @ Dec.1999)...

- 5 Firemen's Pension Scheme...

NOTE: Fire Brigades' Union (FBU) policy £1 m per fire-fighter.

RESPONSIBILITIES

Section 45 A(i) Merchant Shipping Act 1894:

Responsibility for the safety of a ship at sea rests with the Master / Captain and the owner.

Merchant Navy ~

Power delegated from Master to Fire Brigade as accepted practice...

Royal Navy ~

‘a joint approach’.

RECLAIMING COSTS ~ 'SALVAGE'

1. Lloyds forms of salvage not used (Fire Brigade could be liable for losses!)
2. Brigades are not allowed to charge 'for the purposes of fighting fire'.

(Case law: 1999. ex 'Kukawa' fire ~ Cornwall Fire Brigade 1997)...

3. 'Reasonable costs' and ex-gratia payments?

CORNWALL COUNTY FIRE BRIGADE RESPONSE

~ Airborne ~

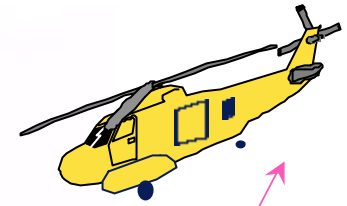

**RAF Chivenor
HMCG Portland**

**Falmouth Fire Station
used as Initial Command
Point (ICP).
Falmouth Docks air RV**

**Brigade Control
Truro**

**RNAS Culdrose,
Cornwall.**

**Falmouth
MRCC**

Response criteria...

- Request from MCA ...
- Request from another source that is approved and supported by the MCA...
- Must be approved by a Fire Brigade 'Principal' Officer - where there is an *immediate risk to life* or high risk of an incident developing that will have a *serious environmental impact*.

Teams...

'Assessment' Team:-

...team of two Officers only. Despatched when very limited information available...

'Strike' Team:-

...team of six, minimum. Despatched when immediate risk to life is known and / or suitable risk assessment has been achieved...

'Support' Teams:-

... as transport resources permit; to allow 'Offensive' tactics to be more suitably introduced.

Command and Control

See Package No. 3A

Summary

- See presentations 3A>5 for the aspects of offshore firefighting, command and control.

Thankyou.

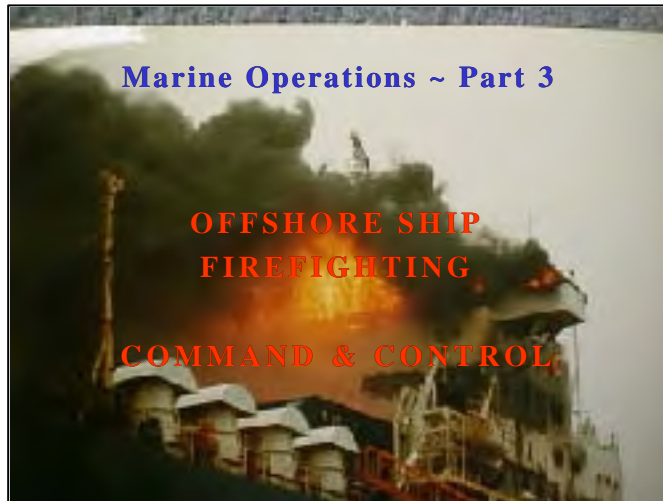

'Pan-Pan' from casualty vessel requesting assistance - MCA collate details, complete Fire Service 'Tasking Form'



Comwall County Fire Brigade Offshore Incidents - Command and Control

MCA ~ Questions to Casualty Master

- **What is the emergency?**
 - **Are there casualties?**
 - **Location of the fire...**
 - **Is the fire spreading?**
- **What is your exact location?**
- **What are the local weather conditions?**
 - **What is the Cargo?**
 - **Is it highly flammable?**
 - **Status of the vessel.**

Cornwall County Fire Brigade Offshore Incidents - Command and Control

The above questions are key to Risk Assessment and form part of the 'Tasking Form'.

**Fire Brigade Control ~ Request for support
from MCA. Inform Duty Principal Officer
for decision.**



Cornwall County Fire Brigade

Offshore Incidents - Command and Control

**Principal Officer and Brigade Control
consider immediate pre-planning**

- Insufficient information – contact MCA for more information before a decision can be made.
- Is the operation of sufficient priority to justify a strike being sent? ie., life threatened or serious environmental impact.
- ‘Assessment or Strike Team’?
- Are there logistical restraints, ie., distance, weather conditions, and do they contain a sufficient safety margin to justify a strike?



Cornwall County Fire Brigade

Offshore Incidents – Command and Control

**Strategy, Tactics and Operations in
the Offshore Arena**

- **STRATEGIC** ~ *'the planning and directing of the organisation to meet the overall objectives'*
... will be carried out at Principal Officer level ...
- **TACTICS** ~ *'the deployment of personnel and equipment to achieve strategic aims'*
... carried out by the Incident Commander who remains at a shorebased Command Centre e.g MRCC ...
- **OPERATIONS** ~ *'carrying out described tasks using prescribed techniques and procedures'*
... determined by the Operations Commander onboard the vessel ...

Comwall County Fire Brigade Offshore Incidents - Command and Control

It must be remembered that Command and Control is of the utmost importance and is required for all incidents. It may, itself, not be in place until sometime after a receipt of the initial call and it is likely that modes of transport to and from the incident will differ with personnel traveling to the incident by helicopter and returning by sea borne transport. It is essential that a system of Command and Control is initiated at an early stage, that it be constantly updated and be available to all necessary Fire Brigade departments and locations as well as outside agencies where applicable, i.e., MRCC.

The PO must be aware of the implications of a prolonged incident, which may impair the ability of the Brigade to react elsewhere.



The 'Command Team' as identified will form part of the 'Strike Team' and may form an assessment team.

They are identified as indicated.

The 'Command Team' are the key officers who determine tactical and operational decision making.

To limit spans of control and maintain good lines of decision making this Command Team must maintain regular communication in line with the agreed principals of the ICS.

They are also responsible for ensuring that key information is cascaded around the incident on a regular basis...every 20 minutes normally, to ensure ALL personnel involved have a full understanding of the situation.

Onboard the vessel the OC is responsible for determining 'Tactical Modes'

(See ICS.ppt presentation for further details on command and control principals set down in accordance with the ICS)

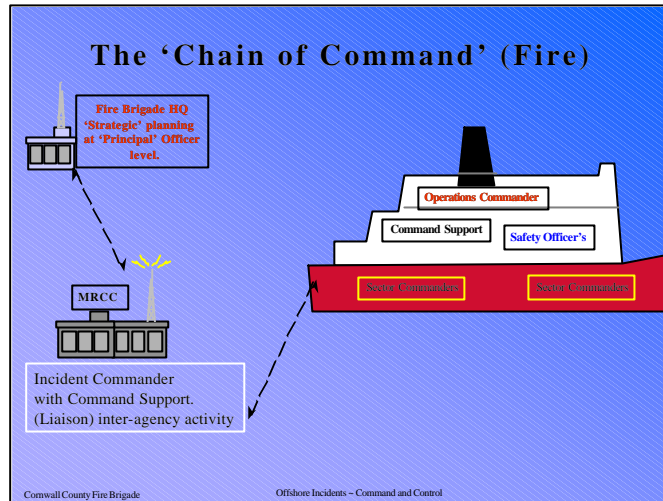

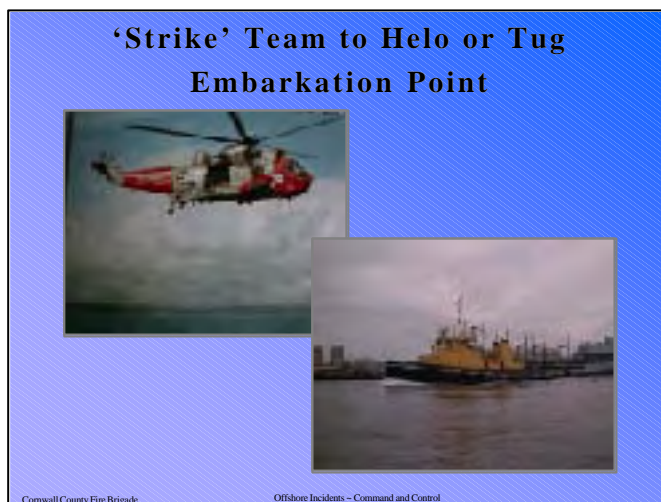

Fire Control / PO Action List

- **Nominate Incident and PO and 'Strike' Team, dispatch to embarkation point...**
- **Nominate and dispatch Embarkation Officers...**
- **Nominate and dispatch Liaison Officer to MCA...**
- **Clarify with MCA that a helicopter has been mobilised, and 'Tasking Form' received...**
- **Request Tug from towage company, nominate 'Strike' Team and dispatch to Waterborne Embarkation Point.**

Cornwall County Fire Brigade Offshore Incidents - Command and Control

A procedure must be in place within Fire Control to ensure the appropriate mobilization actions are taken and recorded.

Some of these procedures may, by local agreement be cascaded to key stations or experienced personnel.

and ...

- **IC to MCA with Command Support to liaise with Coastguard and SOS Representative...**
- **Alert neighbouring offshore response Brigades...**
- **Continue to request information from MCA...**
- **Consider bringing additional resources to alert if 'Support Teams' are required...**
- **Set-up Major Incident Room...**
- **Appropriate provisions to be made to continually inform the next of kin of all personnel deployed offshore.**

Cornwall County Fire Brigade Offshore Incidents - Command and Control

An MCA 'Liaison' Officer must be sent to the nearest MRCC at the outset of an incident, and work closely with a dedicated MCA/Fire Liaison Officer. This is a Command Support function, and may well be supported by a Senior Officer (functional Commander) as the incident expands.

As an 'aid to civil power', military resources may be made available to fly teams from neighbouring Brigades to assist.

When it is known that teams will be deployed a 'functional section commander (Welfare) should be introduced shoreside.

Criteria for Helicopter Operations 

Helicopter transport depends on:

- **Casualties...**
- **Need for deployment...**
- **Distance...**
- **Weather...**
- **Weight...**
- **Safety issues (Operational Safety Margin).**

Cornwall County Fire Brigade Offshore Incidents - Command and Control

Actions for OC prior to mobilisation

- **Select the team...**
- **Confirm number of personnel and weight for flight...**
- **Inform the IC and Embarkation Officer of the number of personnel and equipment required for the flight...**
- **Get further situation report from MCA or Brigade Control...**
- **IC confirm with OC that team briefed on the current situation and their role...**

Cornwall County Fire Brigade Offshore Incidents - Command and Control

The IC in consultation with the PO and identified OC will determine the issues shown.

The IC must ensure at all times that he/she is fully aware of the numbers of persons being transferred etc and continually ensure tactical messages are updated via the MCA.

Prior to embarkation on the 'transport' the IC and OC must communicate and confirm all procedures and R.A.'s have been dealt with.

EMBARKATION (CSO)

- **Nominate and identify a Command Support (Embarkation) Officer..**
- **Issue and duplicate personal tally information on to the Embarkation Board...**
- **Complete Nominal Roll Form (see Helosop)**
- **Pass information to Brigade Control /MCA**
- **Confirm that the loads are correct and that the weights are on the bags**



Embarkation Board



Comwall County Fire Brigade

Offshore Incidents - Command and Control

**Helicopter lands at RV/LZ and Aircrew
liaise with Crew (Ops) Commander**



Comwall County Fire Brigade

Offshore Incidents - Command and Control

BOARDING BOARD (CSO)

- To record all personnel boarding and egressing the casualty i.e receiving tallies.
- Onboard welfare ...



Comwall County Fire Brigade

Offshore Incidents - Command and Control

COMMAND WALLET/BOARD



Corwall County Fire Brigade

Offshore Incidents - Command and Control

Flight Despatched...

**Pre flight safety brief is given before flight
dispatched...**

**Crews now fully dressed in PPE and checked
before boarding...**



Cornwall County Fire Brigade Offshore Incidents - Command and Control

**Arrival at Incident/Risk Assessment
Criteria**

**On arrival Operational Commander
requests fly-by to assess:**

- Fire and smoke conditions...
- Status of the vessel...
- Whether the vessel is still crewed...
- Weather and sea conditions...
- Proximity of support vessels...
- Are Fire Crew to be committed??

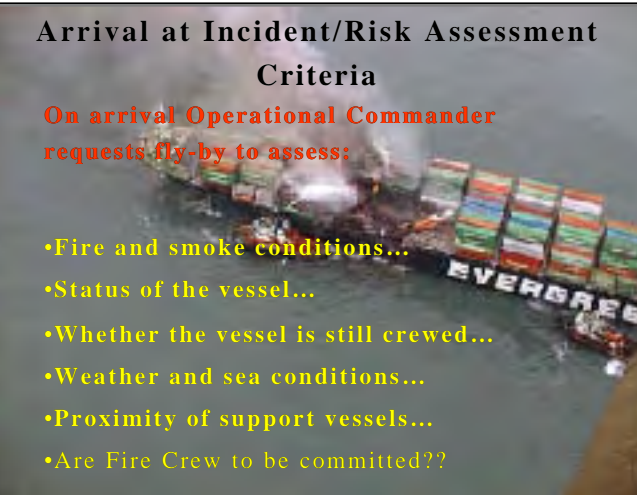

'GO' Situation

**Winchman to deck followed
by Operational Commander,
Command Support,
equipment and remainder of
team.**



Comwall County Fire Brigade

Offshore Incidents - Command and Control

In Attendance

- Operational Commander and Command Support Establish contact with Master of vessel...
- OC confirms Fire Brigade assistance is required.
- Basic Strategy and Tactics agreed by the OC and Master...
- These will be based on a 'Defensive' strategy of containment until support teams arrive.

Cornwall County Fire Brigade

Operational Commander's Responsibilities

- **Establish Command Points, with 'command wallets' on board. Liaise with ship's Master...**
- **Obtain ship's plans...**
- **Maintain communication to MRCC and Fire Brigade CS 'Liaison' Officer...**
- **Dynamic risk assessments, formulate plan, decide all tactics, request assistance (mutual aid)...**
- **Ensure CSO maintains liaison with 'Boarding Officer' at embarkation location.**

Comwall County Fire Brigade Offshore Incidents - Command and Control

As indicated previously.

(see Part 5 of CCFB training packs)

and ...

- **Limit 'span of control' by delegation...**
- **Appoint Sector Commanders/Safety Officers...**
- **Appoint 'functional' officers, eg., stability...**
- **Consider use of ship's crew...**
- **Be aware of:**
 - water supplies ~ boundary starvation/cooling...
 - fixed installations...
 - state of cargo and crew...
- **Continual liaison with ship's officers...**
- **Regular briefings and confirmation of 'tactical modes' (20 mins)...**
- **Safety of all personnel including ship's crew.**

Cornwall County Fire Brigade Offshore Incidents - Command and Control

All 'command' and 'functional' Officers must be identified by the appropriate tabards, and must be properly briefed before accepting the role.

The use of 'recon'/'support'/'attack' fire teams (see Part 5 of CCFB training packs) need to be fully considered, briefed and debriefed.

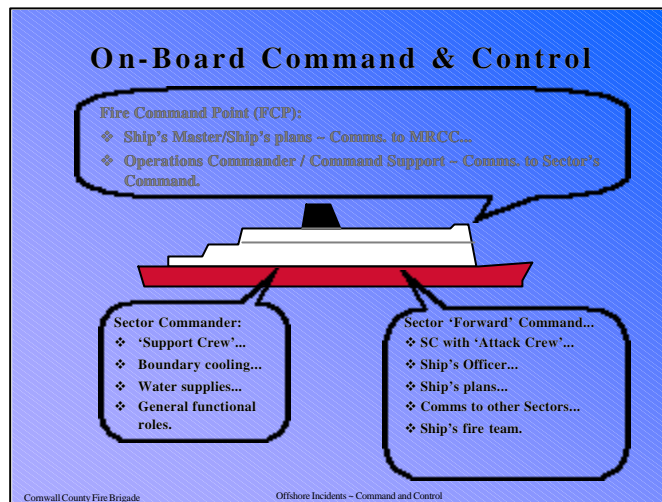

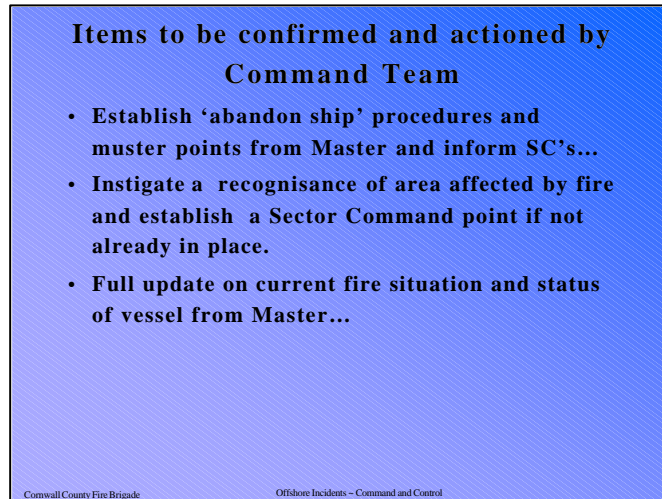

**Items to be confirmed and actioned by
Command Team**

- Establish 'abandon ship' procedures and muster points from Master and inform SC's...
- Instigate a recognisance of area affected by fire and establish a Sector Command point if not already in place.
- Full update on current fire situation and status of vessel from Master...

Comwall County Fire Brigade Offshore Incidents - Command and Control

A good ICS always supports regular briefings to all crew members, and good communications is a key factor in successful command and control.

The 'command team' are the key decision makers and no person should influence key tactical decision making without consultation to the command teams.

Sector Command



Cornwall County Fire Brigade

Offshore Incidents - Command and Control

**Items to be consider and actioned by
the Sector Commander**

- Establish directional safety lines to:
 - i) *Open Air/Muster Points...*
 - ii) *OC at Fire Command Point (FCP).*
- Situation report to OC and Crew Commander's ...
- Regular Tactical Mode messages (20 minutes)...
- Ship expertise available i.e., 1st Officer or Chief Engineer.....
- Ship's plans , ship's crew available or involved in firefighting duties...
- Sufficient resources available to complete the tactics...
- Status of vessel and utility services.

'Offensive' Actions

- **Number of ship's 'Attack Crew's' being used for firefighting purposes...**
- **Fixed installations in use...**
- **Number of BA in use...**
- **Number of hose lines in use...**





At all incidents a level of ‘cordon control’ must be put in place, on small craft this may be the entire vessel and therefore the Boarding’ officer’s nominal role board will be the controlling factor overall . On larger vessel's an inner and outer cordon may be established and the use of a Command Wallet each Sector Command Point should be considered to enhance control. The command wallet should contain numbered armbands to issue, with a safety brief to non Fire Brigade personnel.

An inner cordon refers to an area or section of the vessel which demands a greater degree of control e.g the immediate risk area, and may be clearly defined by watertight bulkheads , decks , compartments etc. All personnel must be aware of the areas within the inner cordon and all plans must indicate this. Any person working within the inner cordon, service or non service must be logged in and out at the Sector Command Point

**Command Support sets up communications
link to MCA and confirms the
numbers of Brigade personnel on board**



**Brigade Liaison Officer at MCA must
ensure that each message received by
MCA is relayed to Brigade Control.**

Cornwall County Fire Brigade

Offshore Incidents - Command and Control

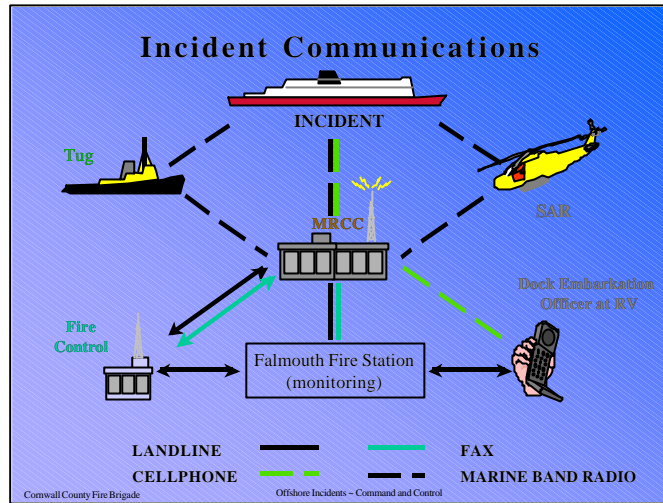



Communication Links

- **Portable marine radios...**
- **Handheld marine radios...**
- **Vessel's marine band fixed radio...**
- **Field telephone system...**
- **Exchanges telephones...**
- **Fax machines...**
- **Cellular telephones...**
- **Brigade main scheme radio.**
- **GMDSS**

Cornwall County Fire Brigade Offshore Incidents - Command and Control

self explanatory.

Assistance/Informative Message

Request for additional resources:

- **Number of firefighters and officers...**
- **The numbers and items of equipment required.**



Cornwall County Fire Brigade

Offshore Incidents - Command and Control

Informative Message (Sit-Rep)

- **Exact fire location:**

Deck level...

Hold or compartment number or machinery space...

Forward, aft or midships...

Port or Starboard.

- **Extent of the fire and what's involved:**

Cargo type...

Type of compartment space.

- **Whether the fire has been contained by closing up:**

Watertight/bulkhead doors, ventilation dampers.

- **Are there any casualties involved:**

Medivac required.

Status of the Vessel

- **Stability...**
- **Whether the ship is still under way...**
- **Ship's utilities are operational,
ie., electrical power and pumps.**

Comwall County Fire Brigade Offshore Incidents - Command and Control

Evacuation of casualty...

- **Roll Calls should be taken and all personnel mustered and the support vessel / aircraft requested to come alongside.**
- **'Boarding Board's' to be taken aboard the support vessel...**
- **Message sent to MCA that all personnel are now aboard the support vessel / aircraft and the casualty vessel has been fully evacuated.**
- **Destination and ETA of support vessel / aircraft to be sent to MCA and Brigade Control...**
- **Upon landing at UK / EU port a full list of names, ranks and numbers to be sent to MCA and Brigade Control.**

On Arrival of 'Support' teams



**A Command Support
'Deck' Officer to be
nominated co
ordinate arriving
support personnel...**

**The Command Support
Boarding Officer will:**
Accept Crew tallies and add to the
Boarding Control Board once
aboard the casualty vessel and
amend details with MCA.



Cornwall County Fire Brigade

Offshore Incidents - Command and Control

'Support Team's' ~ Nomination of Tasks

- Crews and Officers when nominated a task will then be further identified on a tasking record held within the Sector Command Wallet at each Sector...
- Functional Officers will be given specific functional roles:

Water...

Equipment...

BA...

Sectors...

**This allows the provision to Sector evacuate only
and Roll Call for that Sector.**

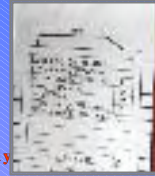

**Operational Commander instigates
further Sit-Rep Message**

- **Send further sit-rep's updating with names and numbers of personnel on board...**
- **Relief times...**
- **Request for personal welfare:**
 - Hot food...**
 - Drink...**
 - Dry clothing...**
 - Personal hygiene.**

Issues to consider over Protracted Time Scales for the Command & Control Team.

- **Status of the vessel...**
- **Weather forecasts...**
- **Can the vessel proceed or will it have to be towed into port...**
- **Fire development...**
- **Physical condition of the firefighters (all personnel not gainfully employed should be rested)...**

and...

- **Relief crews...**
- **Prolonged personnel welfare...**
- **Adjust tactics, to continue 'defensive' or change to 'offensive'.**
- **Regular dialogue with Master and Salvors if appointed...**
- **Environmental issues...**
- **Regular General Roll Calls.**

Successful completion of Incident

- Fire contained and brought under control...
- Vessel docked in foreign port...
- Short, hot debrief...
- and...

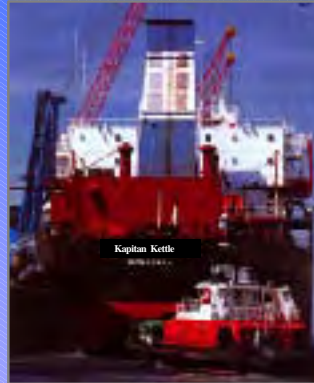

Comwall County Fire Brigade

Offshore Incidents - Command and Control

Ensure...

- **Hand over to relative Fire Brigade...**
- **Roll Call, names, ranks and numbers to be sent to MCA and Brigade Control...**
- **Repatriate the crew and equipment...**
- **Welfare of crew...**
- **Transportation for team and equipment...**
- **Passage to UK and Customs clearance...**
- **Reception party and medical checks if required and inform next of kin...**
- **Incident debrief.**

Cornwall County Fire Brigade Offshore Incidents - Command and Control

- Transport IC to scene to provide full 'incident' brief.
- Passport numbers ? photocopy.

Further Considerations ... The Vessel

- **It may still be on fire. Only 'defensive' tactics carried out, eg., boundary fooling and batten down the fire to enable the ship to evacuate its passengers...**
- **It may be damaged and unsafe by virtue of its cargo...**
- **It may not be able to come into port unaided. (loss of power/crew)...**
- **It may not be allowed in to a port ~ (Harbourmaster's decision).**

... Casualties from the Vessel

- **Fatalities (Police, Coroners, Mortuaries)...**
- **Those without money, cars or luggage ~ needing housing/transport (Local Authority County Emergency plans)...**
- **Seriously injured ~ possibly a large number ~ 40 or more... (Local health authority ~ ambulance)...**
- **Relatives ~ casualties and survivors will have relatives anxious for information and reassurance (Press Bureau)...**
- **Debriefing ~ crew/passengers/Fire Brigade.**

Cornwall County Fire Brigade

Offshore Incidents - Command and Control



Agencies requiring Attention

- **The Media...**
- **Harbour / Port Authorities**

- **National/Local Government VIP's...**

- **Inquiry Boards/Environment
Agencies/Department of Transport...**

- **Inspectorates/Insurers/Local Businesses.**

Comwall County Fire Brigade Offshore Incidents - Command and Control

Whilst the role of the Fire Service is difficult and sometimes, dangerous the challenges of an incident whilst at sea are finite and usually fall within a fairly short time scale.

There are implications for other agencies with regards, for example, fatalities, loss of personal possessions, cars, luggage, seriously injured casualties, anxious relatives. The never ending request from the media, national and local government hierarchy, inquiry boards, environmental agencies, Department of Transport, and local inspectorates and insurers.

All will have implications for shore based agencies which are more diverse and will need to be sustained for a much longer time.

IC/PO Role.

~ SUMMARY ~

**This package outlines the aspects of
offshore Firefighting Command and
Control.**

**It needs to be used in conjunction with the
other packages in this series.**

Thank you.

Cornwall County Fire Brigade

Offshore Incidents - Command and Control

A photograph of an offshore ship at sea, engulfed in a large fire. Thick black smoke billows from the burning area, partially obscuring the sky. The ship's structure, including railings and various equipment, is visible in the foreground. The overall scene is dramatic and highlights the severity of the incident.

Marine Operations ~ Part 3

**OFFSHORE SHIP
FIREFIGHTING**

COMMAND & CONTROL

‘Pan-Pan’ from casualty vessel requesting assistance - MCA collate details, complete Fire Service ‘Tasking Form’



MCA ~ Questions to Casualty Master

- **What is the emergency?**
 - **Are there casualties?**
 - **Location of the fire...**
 - **Is the fire spreading?**
- **What is your exact location?**
- **What are the local weather conditions?**
 - **What is the Cargo?**
 - **Is it highly flammable?**
 - **Status of the vessel.**

Fire Brigade Control ~ Request for support from MCA. Inform Duty Principal Officer for decision.



Principal Officer and Brigade Control consider immediate pre-planning

- Insufficient information ~ **contact MCA for more information before a decision can be made.**
- Is the operation of sufficient priority to justify a strike being sent? ie., life threatened or serious environmental impact.
- ‘Assessment or Strike Team’?
- Are there logistical restraints, ie., distance, weather conditions, and do they contain a sufficient safety margin to justify a strike?



Strategy, Tactics and Operations in the Offshore Arena

- **STRATEGIC** ~ *‘the planning and directing of the organisation to meet the overall objectives’*
... will be carried out at Principal Officer level ...
- **TACTICS** ~ *‘the deployment of personnel and equipment to achieve strategic aims’*
... carried out by the Incident Commander who remains at a shorebased Command Centre e.g MRCC ...
- **OPERATIONS** ~ *‘carrying out described tasks using prescribed techniques and procedures’*
...determined by the Operations Commander onboard the vessel ...

Identification of 'Command Team'

(click to go to ICS)

Tabards identify key personnel as follows:

- Incident Commander (IC) ~ **WHITE...**
- Operations Commander (OC)~ **RED...**
- Sector Commander(SC) ~ **RED & YELLOW...**
- Command Support (CS)~ **RED & WHITE ...**
- Safety Officer (SO) ~ **BLUE & YELLOW.**

The 'Chain of Command' (Fire)

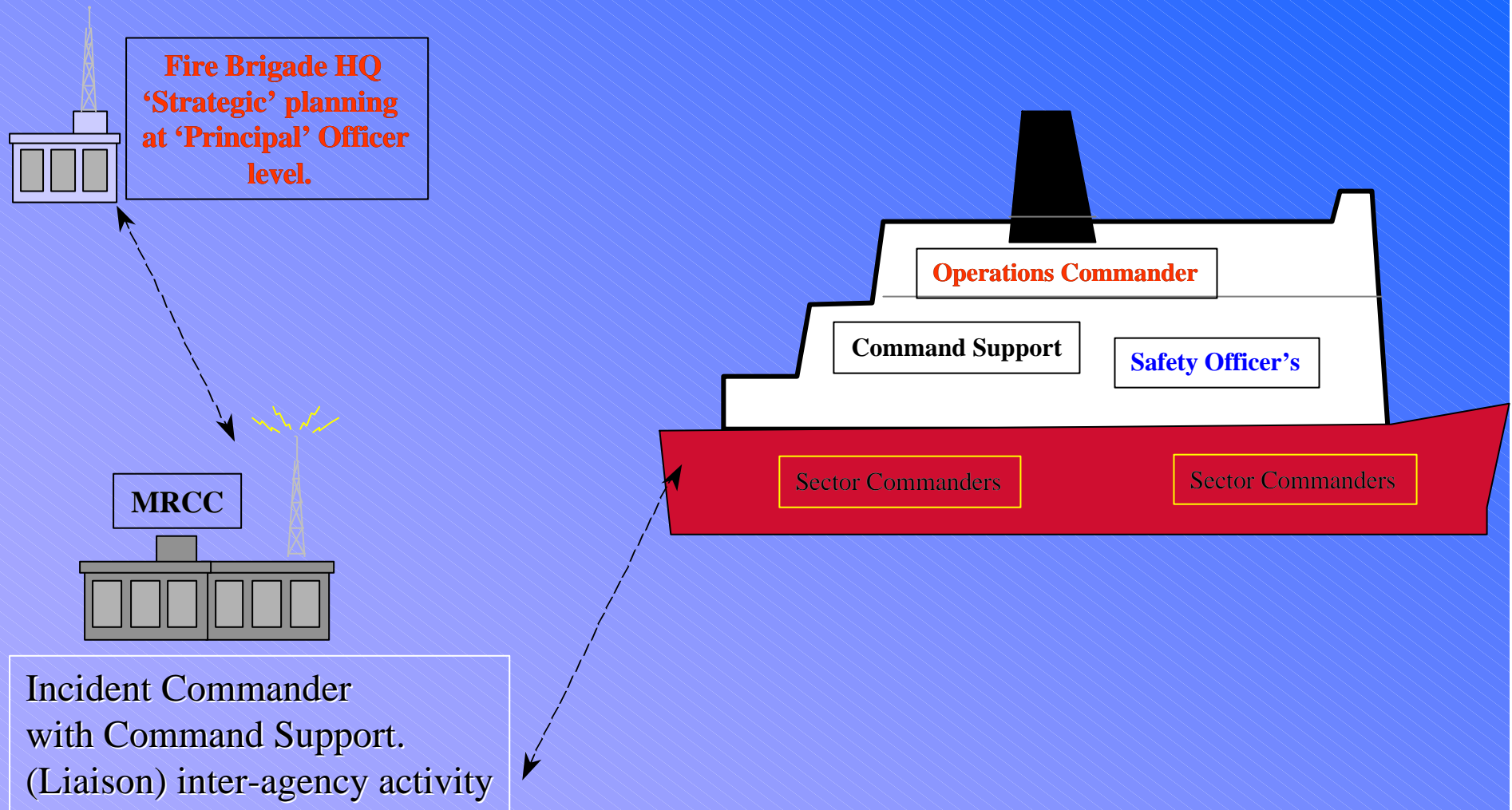

‘Strike’ Team to Helo or Tug Embarkation Point



Fire Control / PO Action List

- **Nominate Incident and PO and ‘Strike’ Team, dispatch to embarkation point...**
- **Nominate and dispatch Embarkation Officers...**
- **Nominate and dispatch Liaison Officer to MCA...**
- **Clarify with MCA that a helicopter has been mobilised, and ‘Tasking Form’ received...**
- **Request Tug from towage company, nominate ‘Strike’ Team and dispatch to Waterborne Embarkation Point.**

and ...

- **IC to MCA with Command Support to liaise with Coastguard and SOS Representative...**
- **Alert neighbouring offshore response Brigades...**
- **Continue to request information from MCA...**
- **Consider bringing additional resources to alert if 'Support Teams' are required...**
- **Set-up Major Incident Room...**
- **Appropriate provisions to be made to continually inform the next of kin of all personnel deployed offshore.**

Criteria for Helicopter Operations



Helicopter transport depends on:

- **Casualties...**
- **Need for deployment...**
- **Distance...**
- **Weather...**
- **Weight...**
- **Safety issues (Operational Safety Margin).**

Actions for OC prior to mobilisation

- **Select the team...**
- **Confirm number of personnel and weight for flight...**
- **Inform the IC and Embarkation Officer of the number of personnel and equipment required for the flight...**
- **Get further situation report from MCA or Brigade Control...**
- **IC confirm with OC that team briefed on the current situation and their role...**

EMBARKATION (CSO)

- **Nominate and identify a Command Support (Embarkation) Officer..**
- **Issue and duplicate personal tally information on to the Embarkation Board...**
- **Complete Nominal Roll Form (see Helosop)**
- **Pass information to Brigade Control /MCA**
- **Confirm that the loads are correct and that the weights are on the bags**



Embarkation Board



Helicopter lands at RV/LZ and Aircrew liaise with Crew (Ops) Commander



BOARDING BOARD (CSO)

- To record all personnel boarding and egressing the casualty i.e receiving tallies.
- Onboard welfare ..



COMMAND WALLET/BOARD



Flight Despatched...

Pre flight safety brief is given before flight
dispatched...

Crews now fully dressed in PPE and checked
before boarding...



Arrival at Incident/Risk Assessment Criteria

On arrival Operational Commander requests fly-by to assess:

- Fire and smoke conditions...
- Status of the vessel...
- Whether the vessel is still crewed...
- Weather and sea conditions...
- Proximity of support vessels...
- Are Fire Crew to be committed??



‘GO’ Situation

**Winchman to deck followed
by Operational Commander,
Command Support,
equipment and remainder of
team.**



In Attendance

- **Operational Commander and Command Support Establish contact with Master of vessel...**
- **OC confirms Fire Brigade assistance is required.**
- **Basic Strategy and Tactics agreed by the OC and Master...**
- **These will be based on a 'Defensive' strategy of containment until support teams arrive.**

Operational Commander's Responsibilities

- **Establish Command Points, with 'command wallets' on board. Liaise with ship's Master...**
- **Obtain ship's plans...**
- **Maintain communication to MRCC and Fire Brigade CS 'Liaison' Officer...**
- **Dynamic risk assessments, formulate plan, decide all tactics, request assistance (mutual aid)...**
- **Ensure CSO maintains liaison with 'Boarding Officer' at embarkation location.**

and ...

- **Limit ‘span of control’ by delegation...**
- **Appoint Sector Commanders/Safety Officers...**
- **Appoint ‘functional’ officers, eg., stability...**
- **Consider use of ship’s crew...**
- **Be aware of:**
 - water supplies ~ boundary starvation/cooling...**
 - fixed installations...**
 - state of cargo and crew...**
- **Continual liaison with ship’s officers...**
- **Regular briefings and confirmation of ‘tactical modes’ (20 mins)...**
- **Safety of all personnel including ship’s crew.**

On-Board Command & Control

Fire Command Point (FCP):

- ❖ Ship's Master/Ship's plans ~ Comms. to MRCC...
- ❖ Operations Commander / Command Support ~ Comms. to Sector's Command.

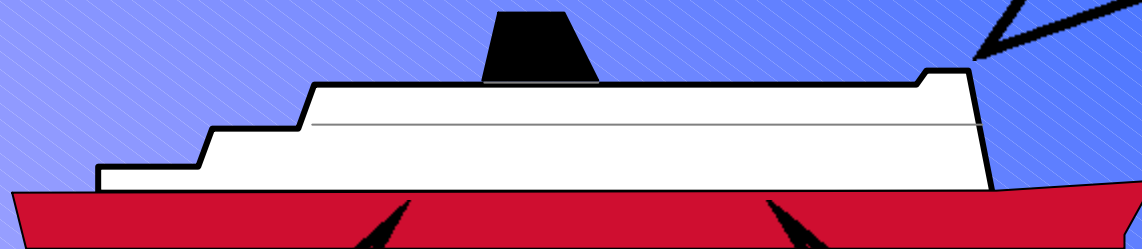

Sector Commander:

- ❖ 'Support Crew'...
- ❖ Boundary cooling...
- ❖ Water supplies...
- ❖ General functional roles.

Sector 'Forward' Command...

- ❖ SC with 'Attack Crew'...
- ❖ Ship's Officer...
- ❖ Ship's plans...
- ❖ Comms to other Sectors...
- ❖ Ship's fire team.

Items to be confirmed and actioned by Command Team

- **Establish ‘abandon ship’ procedures and muster points from Master and inform SC’s...**
- **Instigate a recognisance of area affected by fire and establish a Sector Command point if not already in place.**
- **Full update on current fire situation and status of vessel from Master...**

Sector Command



Items to be consider and actioned by the Sector Commander



- **Establish directional safety lines to:**
 - i) Open Air/Muster Points...*
 - ii) OC at Fire Command Point (FCP).*
- **Situation report to OC and Crew Commander's ...**
- **Regular Tactical Mode messages (20 minutes)...**
- **Ship expertise available i.e., 1st Officer or Chief Engineer.....**
- **Ship's plans , ship's crew available or involved in firefighting duties...**
- **Sufficient resources available to complete the tactics...**
- **Status of vessel and utility services.**

‘Offensive’ Actions

- **Number of ship’s ‘Attack Crew’s’ being used for firefighting purposes...**
- **Fixed installations in use...**
- **Number of BA in use...**
- **Number of hose lines in use...**



Cordon Control

- Cordon Control - to be developed.

Command Support sets up communications link to MCA and confirms the numbers of Brigade personnel on board



Brigade Liaison Officer at MCA must ensure that each message received by MCA is relayed to Brigade Control.

Incident Communications

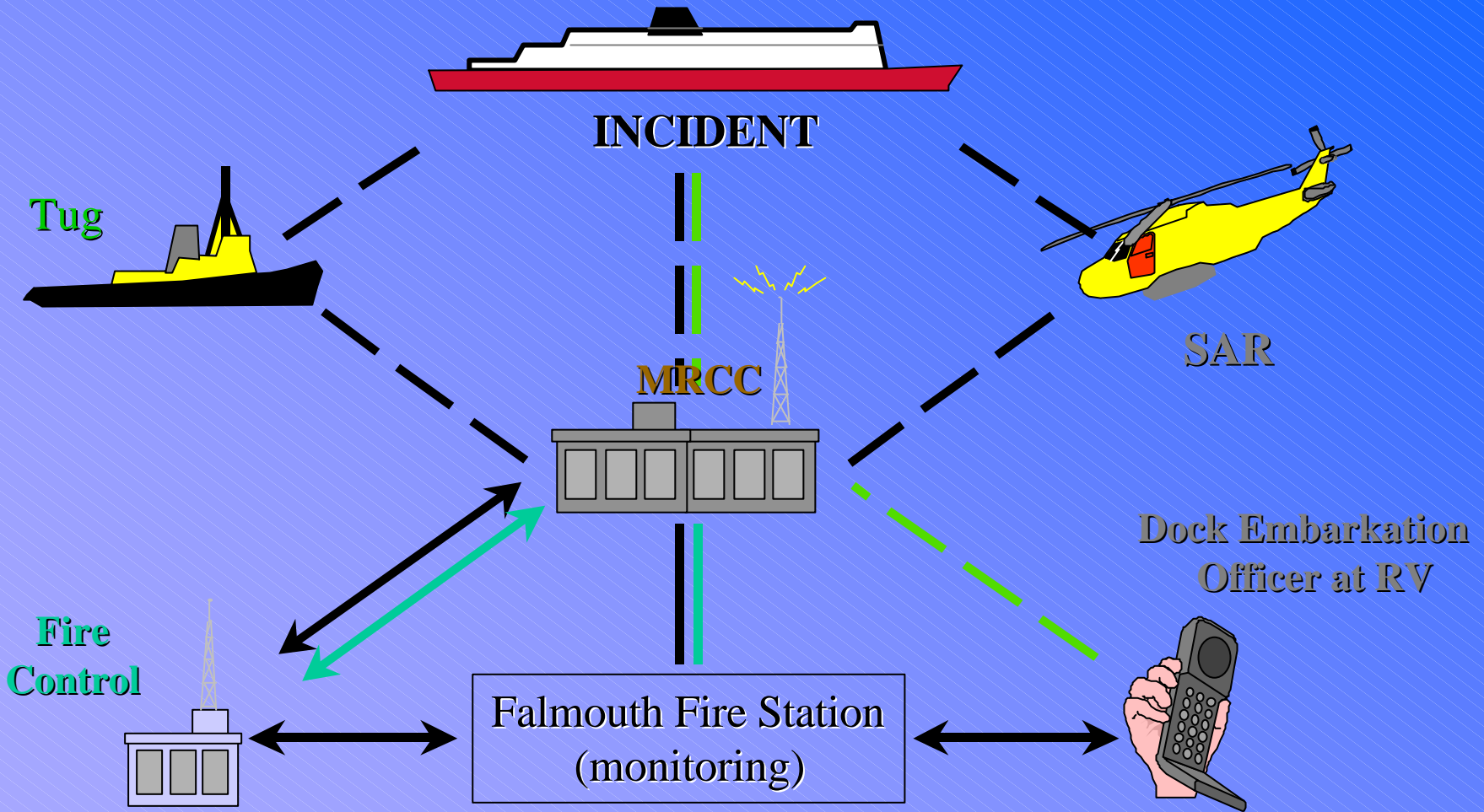

LANDLINE



CELLPHONE



FAX



MARINE BAND RADIO



Communication Links

- **Portable marine radios...**
- **Handheld marine radios...**
- **Vessel's marine band fixed radio...**
- **Field telephone system...**
- **Exchanges telephones...**
- **Fax machines...**
- **Cellular telephones...**
- **Brigade main scheme radio.**
- **GMDSS**

Assistance/Informative Message

Request for additional resources:

- **Number of firefighters and officers...**
- **The numbers and items of equipment required.**



Informative Message (Sit-Rep)

- **Exact fire location:**

 - Deck level...

 - Hold or compartment number or machinery space...

 - Forward, aft or midships...

 - Port or Starboard.

- **Extent of the fire and what's involved:**

 - Cargo type...

 - Type of compartment space.

- **Whether the fire has been contained by closing up:**

 - Watertight/bulkhead doors, ventilation dampers.

- **Are there any casualties involved:**

 - Medivac required.

Status of the Vessel

- **Stability...**
- **Whether the ship is still under way...**
- **Ship's utilities are operational, ie., electrical power and pumps.**

Evacuation of casualty...

- **Roll Calls should be taken and all personnel mustered and the support vessel / aircraft requested to come alongside.**
- **'Boarding Board's' to be taken aboard the support vessel...**
- **Message sent to MCA that all personnel are now aboard the support vessel / aircraft and the casualty vessel has been fully evacuated.**
- **Destination and ETA of support vessel / aircraft to be sent to MCA and Brigade Control...**
- **Upon landing at UK / EU port a full list of names, ranks and numbers to be sent to MCA and Brigade Control.**

On Arrival of 'Support' teams



**A Command Support
'Deck' Officer to be
nominated co
ordinate arriving
support personnel...**

**The Command Support
Boarding Officer will:
Accept Crew tallies and add to the
Boarding Control Board once
aboard the casualty vessel and
amend details with MCA.**



'Support Team's' ~ Nomination of Tasks

- Crews and Officers when nominated a task will then be further identified on a tasking record held within the Sector Command Wallet at each Sector...
- Functional Officers will be given specific functional roles:

Water...

Equipment...

BA...

Sectors...

This allows the provision to Sector evacuate only and Roll Call for that Sector.

NUMBERS ON BOARD	
PERSONNEL	COUNT
OFFICER PERSONNEL	1
FIRE FIGHTER PERSONNEL	1
SHIP PERSONNEL	1
PASSENGERS	1
OTHER AGENCY PERSONNEL	1
OTHER UNKNOWN PERSONNEL	1
TOTAL ON BOARD	6

Operational Commander instigates further Sit-Rep Message

- **Send further sit-rep's updating with names and numbers of personnel on board...**
- **Relief times...**
- **Request for personal welfare:**
 - Hot food...**
 - Drink...**
 - Dry clothing...**
 - Personal hygiene.**

Issues to consider over Protracted Time Scales for the Command & Control Team.

- **Status of the vessel...**
- **Weather forecasts...**
- **Can the vessel proceed or will it have to be towed into port...**
- **Fire development...**
- **Physical condition of the firefighters (all personnel not gainfully employed should be rested)...**

and...

- **Relief crews...**
- **Prolonged personnel welfare...**
- **Adjust tactics, to continue ‘defensive’ or change to ‘offensive’.**
- **Regular dialogue with Master and Salvors if appointed...**
- **Environmental issues...**
- **Regular General Roll Calls.**

Successful completion of Incident

- **Fire contained and brought under control...**
- **Vessel docked in foreign port...**
- **Short, hot debrief...**
- **and...**

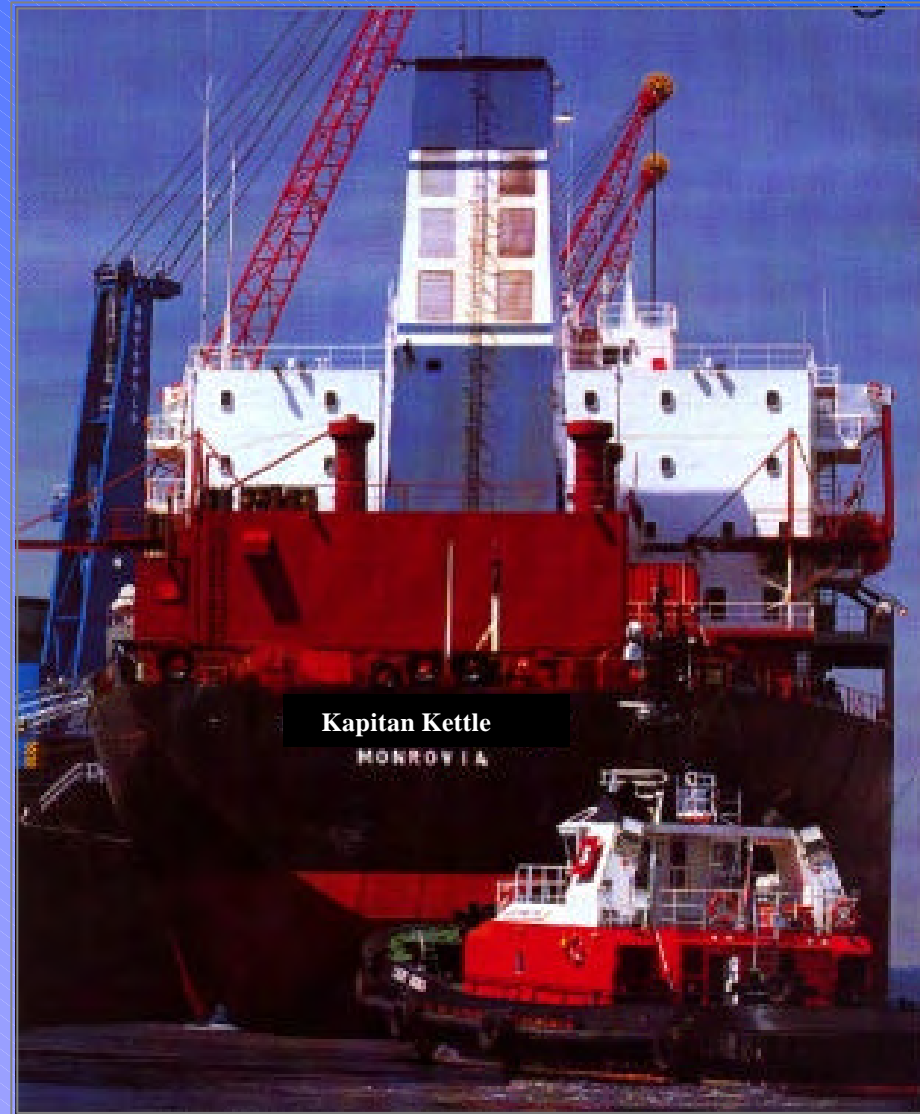

Ensure...

- **Hand over to relative Fire Brigade...**
- **Roll Call, names, ranks and numbers to be sent to MCA and Brigade Control...**
- **Repatriate the crew and equipment...**
- **Welfare of crew...**
- **Transportation for team and equipment...**
- **Passage to UK and Customs clearance...**
- **Reception party and medical checks if required and inform next of kin...**
- **Incident debrief.**

Further Considerations ... The Vessel

- **It may still be on fire. Only ‘defensive’ tactics carried out, eg., boundary fooling and batten down the fire to enable the ship to evacuate its passengers...**
- **It may be damaged and unsafe by virtue of its cargo...**
- **It may not be able to come into port unaided. (loss of power/crew)...**
- **It may not be allowed in to a port ~ (Harbourmaster’s decision).**

... Casualties from the Vessel

- **Fatalities (Police, Coroners, Mortuaries)...**
- **Those without money, cars or luggage ~ needing housing/transport (Local Authority County Emergency plans)...**
- **Seriously injured ~ possibly a large number ~ 40 or more... (Local health authority ~ ambulance)...**
- **Relatives ~ casualties and survivors will have relatives anxious for information and reassurance (Press Bureau)...**
- **Debriefing ~ crew/passengers/Fire Brigade.**

Agencies requiring Attention

- **The Media...**
- **Harbour / Port Authorities**
- **National/Local Government VIP's...**
- **Inquiry Boards/Environment Agencies/Department of Transport...**
- **Inspectorates/Insurers/Local Businesses.**

~ SUMMARY ~

This package outlines the aspects of offshore Firefighting Command and Control.

It needs to be used in conjunction with the other packages in this series.

Thank you.

A photograph of an offshore ship at sea, engulfed in a large fire. Thick black smoke billows from the burning area, partially obscuring the sky. The ship's structure, including railings and a crane, is visible in the foreground. The overall scene is dramatic and hazardous.

Marine Operations ~ Part 3

**OFFSHORE SHIP
FIREFIGHTING**

COMMAND & CONTROL

‘Pan-Pan’ from casualty vessel requesting assistance - MCA collate details, complete Fire Service ‘Tasking Form’



MCA ~ Questions to Casualty Master

- **What is the emergency?**
 - **Are there casualties?**
 - **Location of the fire...**
 - **Is the fire spreading?**
- **What is your exact location?**
- **What are the local weather conditions?**
 - **What is the Cargo?**
 - **Is it highly flammable?**
 - **Status of the vessel.**

Fire Brigade Control ~ Request for support from MCA. Inform Duty Principal Officer for decision.



Principal Officer and Brigade Control consider immediate pre-planning

- Insufficient information ~ **contact MCA for more information before a decision can be made.**
- Is the operation of sufficient priority to justify a strike being sent? ie., life threatened or serious environmental impact.
- ‘Assessment or Strike Team’?
- Are there logistical restraints, ie., distance, weather conditions, and do they contain a sufficient safety margin to justify a strike?



Strategy, Tactics and Operations in the Offshore Arena

- **STRATEGIC** ~ *‘the planning and directing of the organisation to meet the overall objectives’*
... will be carried out at Principal Officer level ...
- **TACTICS** ~ *‘the deployment of personnel and equipment to achieve strategic aims’*
... carried out by the Incident Commander who remains at a shorebased Command Centre e.g MRCC ...
- **OPERATIONS** ~ *‘carrying out described tasks using prescribed techniques and procedures’*
...determined by the Operations Commander onboard the vessel ...

Identification of 'Command Team'

(click to go to ICS)

Tabards identify key personnel as follows:

- Incident Commander (IC) ~ **WHITE...**
- Operations Commander (OC)~ **RED...**
- Sector Commander(SC) ~ **RED & YELLOW...**
- Command Support (CS)~ **RED & WHITE ...**
- Safety Officer (SO) ~ **BLUE & YELLOW.**

The 'Chain of Command' (Fire)

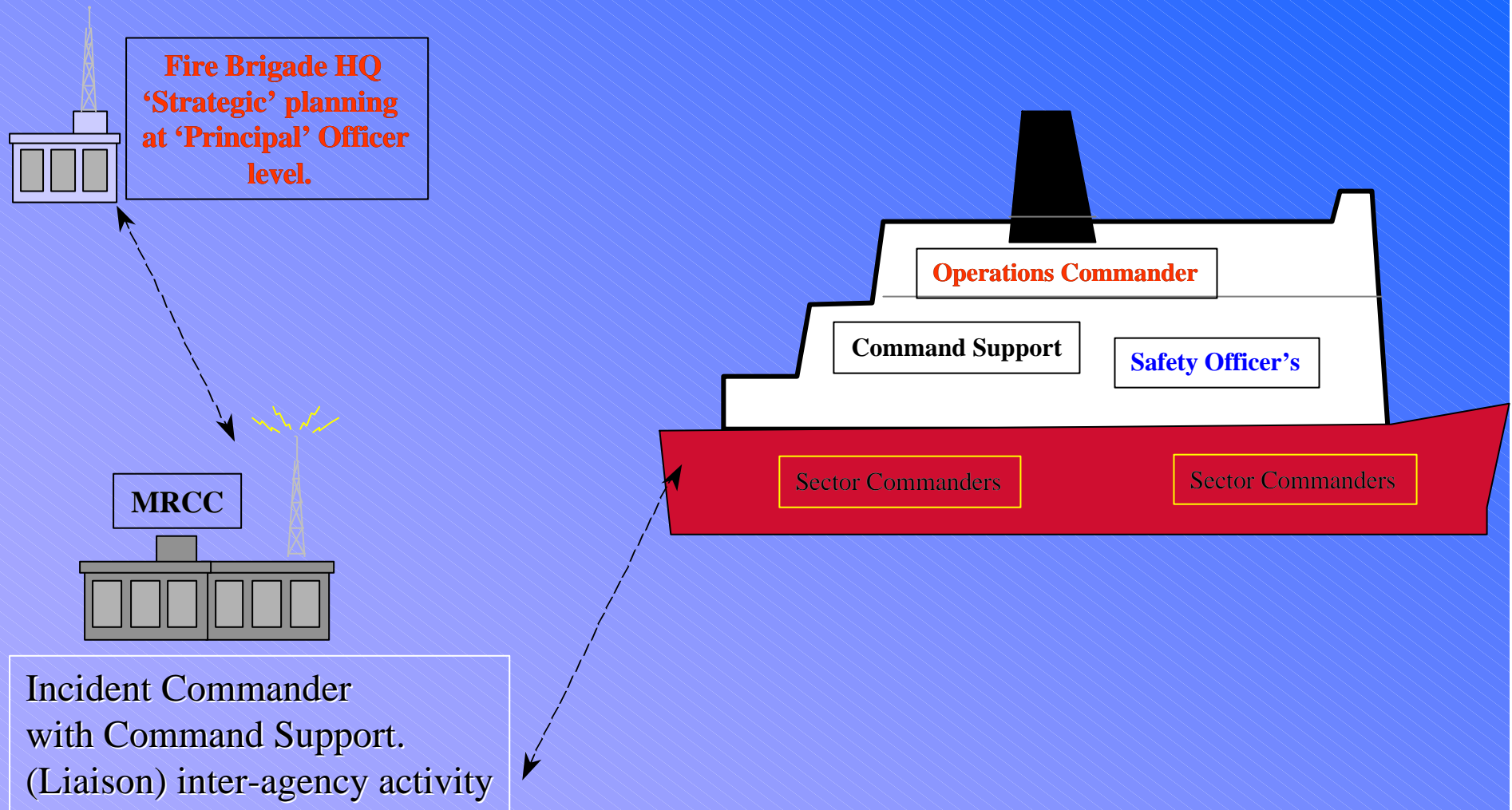

‘Strike’ Team to Helo or Tug Embarkation Point



Fire Control / PO Action List

- **Nominate Incident and PO and ‘Strike’ Team, dispatch to embarkation point...**
- **Nominate and dispatch Embarkation Officers...**
- **Nominate and dispatch Liaison Officer to MCA...**
- **Clarify with MCA that a helicopter has been mobilised, and ‘Tasking Form’ received...**
- **Request Tug from towage company, nominate ‘Strike’ Team and dispatch to Waterborne Embarkation Point.**

and ...

- **IC to MCA with Command Support to liaise with Coastguard and SOS Representative...**
- **Alert neighbouring offshore response Brigades...**
- **Continue to request information from MCA...**
- **Consider bringing additional resources to alert if 'Support Teams' are required...**
- **Set-up Major Incident Room...**
- **Appropriate provisions to be made to continually inform the next of kin of all personnel deployed offshore.**

Criteria for Helicopter Operations



Helicopter transport depends on:

- **Casualties...**
- **Need for deployment...**
- **Distance...**
- **Weather...**
- **Weight...**
- **Safety issues (Operational Safety Margin).**

Actions for OC prior to mobilisation

- **Select the team...**
- **Confirm number of personnel and weight for flight...**
- **Inform the IC and Embarkation Officer of the number of personnel and equipment required for the flight...**
- **Get further situation report from MCA or Brigade Control...**
- **IC confirm with OC that team briefed on the current situation and their role...**

EMBARKATION (CSO)

- **Nominate and identify a Command Support (Embarkation) Officer..**
- **Issue and duplicate personal tally information on to the Embarkation Board...**
- **Complete Nominal Roll Form (see Helosop)**
- **Pass information to Brigade Control /MCA**
- **Confirm that the loads are correct and that the weights are on the bags**



Embarkation Board



Helicopter lands at RV/LZ and Aircrew liaise with Crew (Ops) Commander



BOARDING BOARD (CSO)

- To record all personnel boarding and egressing the casualty i.e receiving tallies.
- Onboard welfare ..



COMMAND WALLET/BOARD



Flight Despatched...

Pre flight safety brief is given before flight
dispatched...

Crews now fully dressed in PPE and checked
before boarding...



Arrival at Incident/Risk Assessment Criteria

On arrival Operational Commander requests fly-by to assess:

- Fire and smoke conditions...
- Status of the vessel...
- Whether the vessel is still crewed...
- Weather and sea conditions...
- Proximity of support vessels...
- Are Fire Crew to be committed??



‘GO’ Situation

**Winchman to deck followed
by Operational Commander,
Command Support,
equipment and remainder of
team.**



In Attendance

- **Operational Commander and Command Support Establish contact with Master of vessel...**
- **OC confirms Fire Brigade assistance is required.**
- **Basic Strategy and Tactics agreed by the OC and Master...**
- **These will be based on a 'Defensive' strategy of containment until support teams arrive.**

Operational Commander's Responsibilities

- **Establish Command Points, with 'command wallets' on board. Liaise with ship's Master...**
- **Obtain ship's plans...**
- **Maintain communication to MRCC and Fire Brigade CS 'Liaison' Officer...**
- **Dynamic risk assessments, formulate plan, decide all tactics, request assistance (mutual aid)...**
- **Ensure CSO maintains liaison with 'Boarding Officer' at embarkation location.**

and ...

- **Limit ‘span of control’ by delegation...**
- **Appoint Sector Commanders/Safety Officers...**
- **Appoint ‘functional’ officers, eg., stability...**
- **Consider use of ship’s crew...**
- **Be aware of:**
 - water supplies ~ boundary starvation/cooling...**
 - fixed installations...**
 - state of cargo and crew...**
- **Continual liaison with ship’s officers...**
- **Regular briefings and confirmation of ‘tactical modes’ (20 mins)...**
- **Safety of all personnel including ship’s crew.**

On-Board Command & Control

Fire Command Point (FCP):

- ❖ Ship's Master/Ship's plans ~ Comms. to MRCC...
- ❖ Operations Commander / Command Support ~ Comms. to Sector's Command.

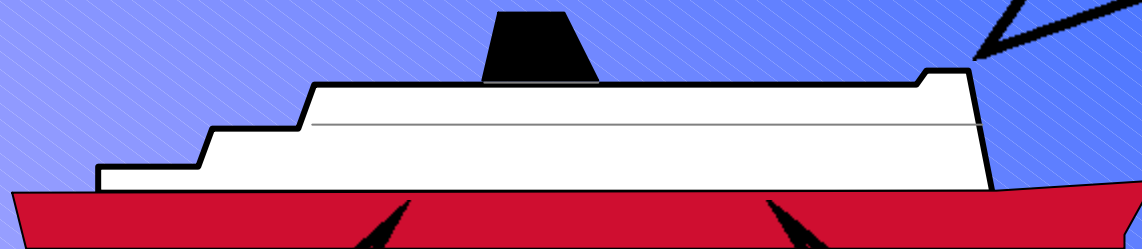

Sector Commander:

- ❖ 'Support Crew'...
- ❖ Boundary cooling...
- ❖ Water supplies...
- ❖ General functional roles.

Sector 'Forward' Command...

- ❖ SC with 'Attack Crew'...
- ❖ Ship's Officer...
- ❖ Ship's plans...
- ❖ Comms to other Sectors...
- ❖ Ship's fire team.

Items to be confirmed and actioned by Command Team

- **Establish ‘abandon ship’ procedures and muster points from Master and inform SC’s...**
- **Instigate a recognisance of area affected by fire and establish a Sector Command point if not already in place.**
- **Full update on current fire situation and status of vessel from Master...**

Sector Command



Items to be consider and actioned by the Sector Commander



- **Establish directional safety lines to:**
 - i) Open Air/Muster Points...*
 - ii) OC at Fire Command Point (FCP).*
- **Situation report to OC and Crew Commander's ...**
- **Regular Tactical Mode messages (20 minutes)...**
- **Ship expertise available i.e., 1st Officer or Chief Engineer.....**
- **Ship's plans , ship's crew available or involved in firefighting duties...**
- **Sufficient resources available to complete the tactics...**
- **Status of vessel and utility services.**

‘Offensive’ Actions

- **Number of ship’s ‘Attack Crew’s’ being used for firefighting purposes...**
- **Fixed installations in use...**
- **Number of BA in use...**
- **Number of hose lines in use...**



Cordon Control

- Cordon Control - to be developed.

Command Support sets up communications link to MCA and confirms the numbers of Brigade personnel on board



Brigade Liaison Officer at MCA must ensure that each message received by MCA is relayed to Brigade Control.

Incident Communications

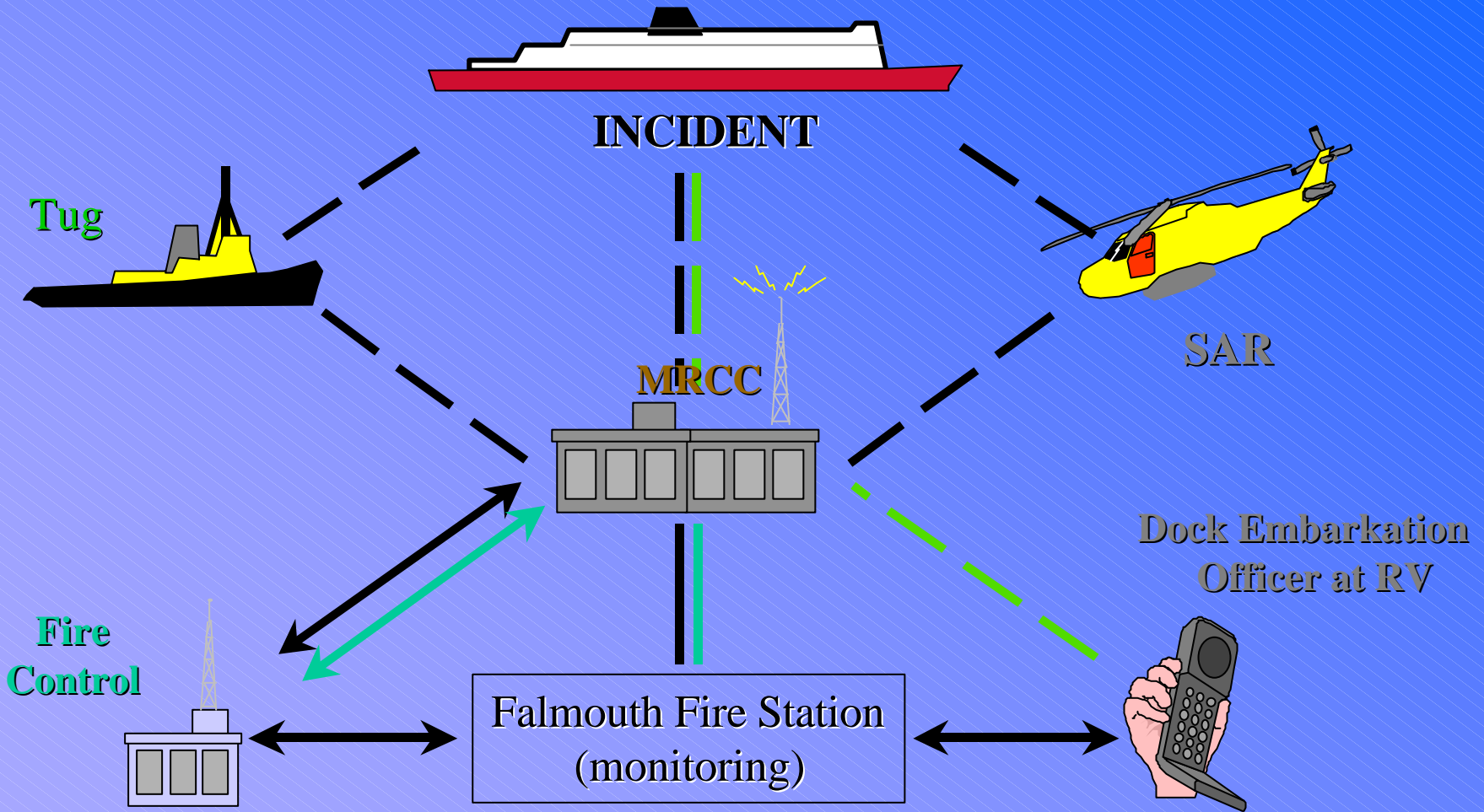

LANDLINE



FAX

CELLPHONE



MARINE BAND RADIO

Communication Links

- **Portable marine radios...**
- **Handheld marine radios...**
- **Vessel's marine band fixed radio...**
- **Field telephone system...**
- **Exchanges telephones...**
- **Fax machines...**
- **Cellular telephones...**
- **Brigade main scheme radio.**
- **GMDSS**

Assistance/Informative Message

Request for additional resources:

- **Number of firefighters and officers...**
- **The numbers and items of equipment required.**



Informative Message (Sit-Rep)

- **Exact fire location:**

 - Deck level...

 - Hold or compartment number or machinery space...

 - Forward, aft or midships...

 - Port or Starboard.

- **Extent of the fire and what's involved:**

 - Cargo type...

 - Type of compartment space.

- **Whether the fire has been contained by closing up:**

 - Watertight/bulkhead doors, ventilation dampers.

- **Are there any casualties involved:**

 - Medivac required.

Status of the Vessel

- **Stability...**
- **Whether the ship is still under way...**
- **Ship's utilities are operational, ie., electrical power and pumps.**

Evacuation of casualty...

- **Roll Calls should be taken and all personnel mustered and the support vessel / aircraft requested to come alongside.**
- **'Boarding Board's' to be taken aboard the support vessel...**
- **Message sent to MCA that all personnel are now aboard the support vessel / aircraft and the casualty vessel has been fully evacuated.**
- **Destination and ETA of support vessel / aircraft to be sent to MCA and Brigade Control...**
- **Upon landing at UK / EU port a full list of names, ranks and numbers to be sent to MCA and Brigade Control.**

On Arrival of 'Support' teams



**A Command Support
'Deck' Officer to be
nominated co
ordinate arriving
support personnel...**

**The Command Support
Boarding Officer will:
Accept Crew tallies and add to the
Boarding Control Board once
aboard the casualty vessel and
amend details with MCA.**



'Support Team's' ~ Nomination of Tasks

- Crews and Officers when nominated a task will then be further identified on a tasking record held within the Sector Command Wallet at each Sector...
- Functional Officers will be given specific functional roles:

Water...

Equipment...

BA...

Sectors...

This allows the provision to Sector evacuate only and Roll Call for that Sector.

NUMBERS ON BOARD	
PERSONNEL	COUNT
OFFICERS & RBC OFFICERS PERSONNEL	
FIRE WALLBORNE PERSONNEL	1
SHIP PERSONNEL	10
PASSENGERS	
OTHER AGENCY PERSONNEL	1
OTHER UNKNOWN PERSONNEL	1
TOTAL ON BOARD	14

Operational Commander instigates further Sit-Rep Message

- **Send further sit-rep's updating with names and numbers of personnel on board...**
- **Relief times...**
- **Request for personal welfare:**
 - Hot food...**
 - Drink...**
 - Dry clothing...**
 - Personal hygiene.**

Issues to consider over Protracted Time Scales for the Command & Control Team.

- **Status of the vessel...**
- **Weather forecasts...**
- **Can the vessel proceed or will it have to be towed into port...**
- **Fire development...**
- **Physical condition of the firefighters (all personnel not gainfully employed should be rested)...**

and...

- **Relief crews...**
- **Prolonged personnel welfare...**
- **Adjust tactics, to continue 'defensive' or change to 'offensive'.**
- **Regular dialogue with Master and Salvors if appointed...**
- **Environmental issues...**
- **Regular General Roll Calls.**

Successful completion of Incident

- **Fire contained and brought under control...**
- **Vessel docked in foreign port...**
- **Short, hot debrief...**
- **and...**

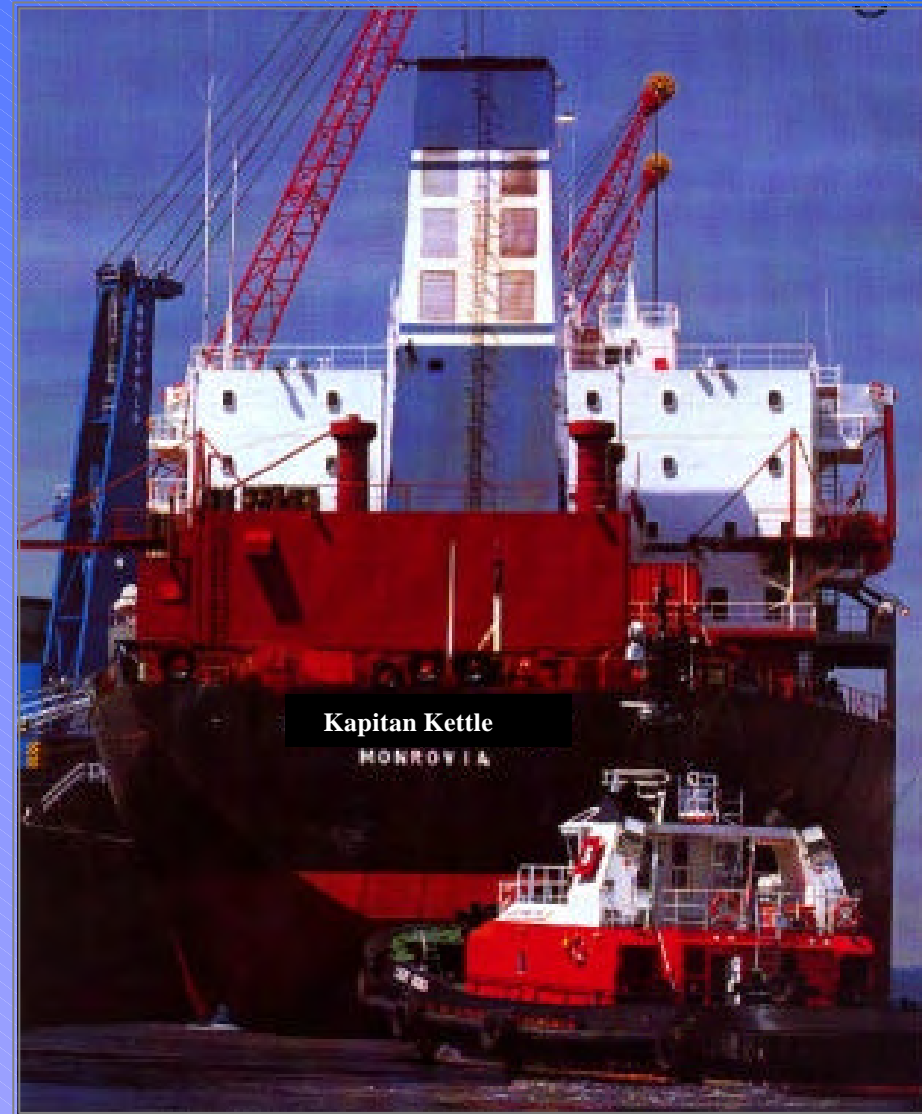

Ensure...

- **Hand over to relative Fire Brigade...**
- **Roll Call, names, ranks and numbers to be sent to MCA and Brigade Control...**
- **Repatriate the crew and equipment...**
- **Welfare of crew...**
- **Transportation for team and equipment...**
- **Passage to UK and Customs clearance...**
- **Reception party and medical checks if required and inform next of kin...**
- **Incident debrief.**

Further Considerations ... The Vessel

- **It may still be on fire. Only ‘defensive’ tactics carried out, eg., boundary fooling and batten down the fire to enable the ship to evacuate its passengers...**
- **It may be damaged and unsafe by virtue of its cargo...**
- **It may not be able to come into port unaided. (loss of power/crew)...**
- **It may not be allowed in to a port ~ (Harbourmaster’s decision).**

... Casualties from the Vessel

- **Fatalities (Police, Coroners, Mortuaries)...**
- **Those without money, cars or luggage ~ needing housing/transport (Local Authority County Emergency plans)...**
- **Seriously injured ~ possibly a large number ~ 40 or more... (Local health authority ~ ambulance)...**
- **Relatives ~ casualties and survivors will have relatives anxious for information and reassurance (Press Bureau)...**
- **Debriefing ~ crew/passengers/Fire Brigade.**

Agencies requiring Attention

- **The Media...**
- **Harbour / Port Authorities**
- **National/Local Government VIP's...**
- **Inquiry Boards/Environment Agencies/Department of Transport...**
- **Inspectorates/Insurers/Local Businesses.**

~ SUMMARY ~

This package outlines the aspects of offshore Firefighting Command and Control.

It needs to be used in conjunction with the other packages in this series.

Thank you.

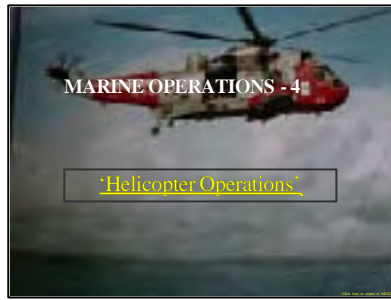

The 'Marine Operations' packages are produced by CCFB Marine Operations Group (MOG) and are as follows

Part 1...Safe Working On Or Near Water...

Part 2...Offshore Incidents ~The Legal Framework

Part 3...Offshore Incidents ~Command and Control

Part 4...Helicopter Operations ~ SOP

Part 5...Tactical Ship Firefighting

Part 6...Ship construction.

Part 7...Sea Survival

Part 8...Small Boat Fire Safety

Other reference points include:-

ICS.ppt

Fire Service Manuals ~ Command and Control / Marine Operations...

DCOL's...

BIS Doc's...

Case Studies e.g 'Scandinavian Star'

CACFOA South West ICS packages

Response criteria...

- Request from MCA ...
- Request from another source that is approved and supported by the MCA...
- Must be approved by a Fire Brigade 'Principal' Officer - where there is an *immediate risk to life* or high risk of an incident developing that will have a *serious environmental impact*.

Cornwall County Fire Brigade Helicopter Operations December 2000

IT IS ANTICIPATED HELICOPTER RESPONSE TEAMS ACTING IN ISOLATION CANNOT AND WILL NOT INITIATE 'OFFENSIVE' TACTICS.

The defined task will be to provide actions and make provisions for when additional resources become available.

The MCA will seek the help of the relevant Fire Service after receiving a request for Fire Service assistance from the Master of a vessel at sea. It is considered that Fire Services/Brigades may respond to calls for assistance particularly where life is at risk. The decision to attend or not will be made by the appropriate Chief Fire Officer or his/her nominated representative.

The Chief Fire Officer Firemaster or his/her representative will require specific information before committing the resources of his Fire Service. The form detailed in Section 19 should be used for this purpose. In the first instance HM Coastguard should attempt to complete those items asterisked and in bold print. This should also be faxed to the Fire Service by the co-ordinating HM Coastguard station. Subsequent information can be added when required by the Coastguard.

Teams...

'Assessment' Team:-
...team of two Officers only. Despatched when very limited information available...

'Strike' Team:-
...team of six, minimum. Despatched when immediate risk to life is known and / or suitable risk assessment has been achieved...

'Support' Teams:-
... as transport resources permit; to allow 'Offensive' tactics to be more suitably introduced.

Cornwall County Fire Brigade Helicopter Operations December 2000

Self explanatory..to be discussed in detail..

‘ASSESSMENT’ TEAM...
Primary Objectives

- ① Provide first impression risk assessment information...
- ② Maintain communications links with MRCC...
- ③ Provide professional advice on matters relating to fire...
- ④ Formulate plan - if appropriate, advise Fire Brigade ‘Principal’ Officer (shoreside), to allow strategic decision making process...
- ⑤ Keep MRCC fully advised.

NOTE: This team ‘may’ be transported by air or sea

Cornwall County Fire Brigade Helicopter Operations December 2000

Minimum of two Officers *with the relevant competencies...the ‘assessment’ team may form part of a larger ‘multi agency’ response*

The team should wear full PPE i.e immersion suit and lifejacket and carry a minimum of equipment as follows:-

Welfare packs (2kgs)

Marine band radios.. two (1kg)

Heavy duty torch (1 kg)

Thermal Image camera (8kg)

Notebooks / Dictaphone

**‘STRIKE’ TEAM (Airborne) -
Composition - minimum of 6**

- ‘Operations’ Commander [OC]....Tactical decision maker...
- ‘Sector’ (or ‘Forward’) Commander...second in command...
- ‘Command Support’...to assist the OC, comms. etc...
- Team Members (3) ... ‘defensive’ tactics only.

The ‘Strike’ team may be the initial team and therefore will need to carry out the primary objectives of the ‘Assessment’ team before any further actions are taken.

(A waterborne ‘strike’ team may consist of up to 20 personnel (C/TFB))

Cornwall County Fire Brigade Helicopter Operations December 2000

Team of six, *maximum eight, with pre designated equipment bags - One - Two - Three*

Minimum of two Officers with relevant competencies if no ‘Assessment’ team previously mobilised.

This will provide an Operations Commander and / Command Support.

The final decision for deployment of personnel *to the casualty* will rest with the OC.

The ‘Strike’ team consists of only Fire Service personnel

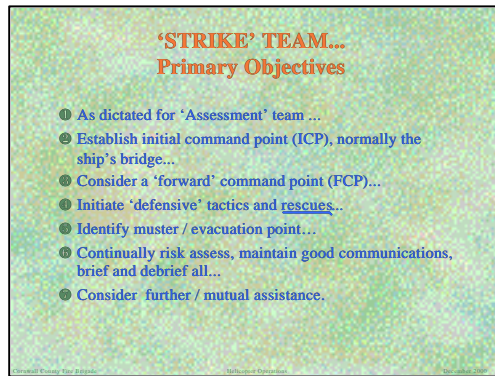

Carry out a risk assessment (*as per the 'Assessment' team if not previously deployed*).

Collect information .

Identify ICP and evacuation point

Rescues may not be an option....

Transmit a full situation report via the co-ordinating HM Coastguard Station.

Make provision for: Command and Control, Safety and Welfare, Comms.

To provide the CFO / Firemaster with a risk assessment to enable decision on further deployment to be made at the strategic level.

Request necessary resources to enable the incident to be dealt with effectively. The resources requested should be prioritised to enable proper logistical planning by onshore organisation.

MINIMUM LOAD FOR 'STRIKE' TEAM ~ Airborne ~		
<p>BAG 1</p> <ul style="list-style-type: none"> ➤ Bag /box ➤ 2 x CABA sets ➤ BA boards ➤ Thermal image camera(TIC) ➤ First aid box ➤ 2 torches ➤ 2 x Marine band portable radios and spare batteries <p>Weight: 65kgs.</p>	<p>BAG 2</p> <ul style="list-style-type: none"> ➤ Bag /box ➤ 2 x CABA sets ➤ 4 x handheld radios and waterproof covers. ➤ 4 torches ➤ Incident control board ➤ Transit line or guide tape <p>Weight: 61kgs.</p>	<p>BAG 3</p> <ul style="list-style-type: none"> ➤ Bag /box ➤ 2 x CABA sets ➤ Welfare pack ➤ Field telephone ➤ Cable drum <p>Weight: 65kgs</p>
<p>TEAM of SIX: 600 kgs</p>		<p>TOTAL LOAD: < 800 kgs</p>

Maximum loads may differ for different types of helicopter. In all cases the maximum load will be at the direction of the helicopter loadmaster or pilot.

Fire Services should have available prepared equipment lists with weights in lbs./kgs to cover all the equipment likely to be utilised. Weight calculation charts should also be incorporated *and account must be taking of Manual Handling regulations*

Brigades will have prepared equipment lists for the appropriate teams. Further specific loads will depend on the nature of the incident. However, it is anticipated that equipment dumps will be prepared at helicopter landing sites or waterborne embarkation points for water, foam, breathing apparatus, rescue and/or chemical protection equipment in preparation for further flights.

ALL BRIGADES NEED TO ADOPT THE SAME IDENTIFICATION ETC TO AVOID DUPLICATION FROM 'MUTUAL AID' INCIDENTS



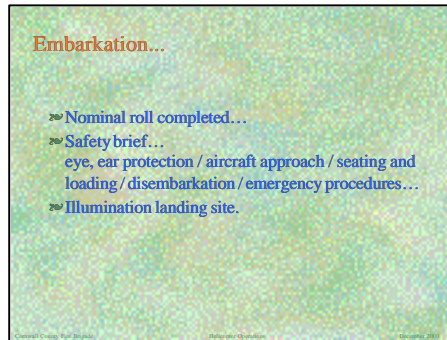

In all circumstances a nominal roll form (Section 20) should be completed to record all personnel taken offshore. Copies of this should be FAXED to HM Coastguard, HM Customs and the HM Immigration Office which covers the Service/Brigade where the incident has occurred. With HM Coastguard being the central coordinator in cases of repatriation, if this becomes necessary.

In the case of firefighters returning to shore, their Fire Control Centers must fax their names to HM Coastguard to ensure nominal rolls are always current.

Prior to departure / embarkation all crews must have received a pre flight safety brief. This must include details on the aircraft to be used, appropriate use of PPE .e.g. eye, ear protection, methods of approach, seating and equipment location, disembarkation and emergency procedures.

The pilot may require illumination of the landing zone (lz) when collecting or returning crews, this may be done by the use of two Fire appliance's headlights directed in a vee shape on the lz. Night vision goggles will not normally be used by the aircrew in these circumstances, but strong torches etc should never be shone directly at the aircraft.

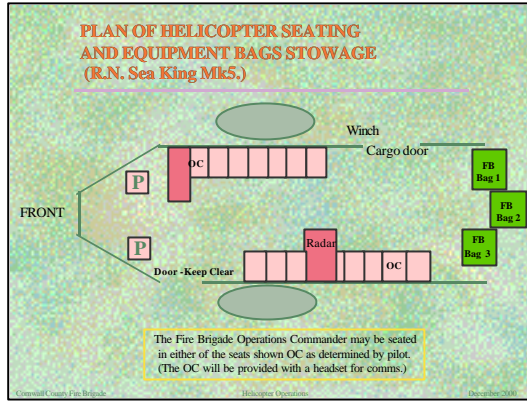

Equipment & Communications...

- Suitable equipment...
- Suitable PPE...
- Use of communications...
- Maintaining communications.

Cornwall County Fire Brigade Helicopter Operations December 2000

The teams, personnel and equipment should meet the following:

Current standards for the safety and protection of personnel during transportation, transfer and activities on board vessels in need of assistance.

Current standards for the safety and protection of personnel during firefighting and associated activities.

Enable personnel to communicate to the relevant rescue co-ordination centre.

.

All portable radio equipment including cellphones, taken on board a helicopter must be switched OFF and must not be operated inside the helicopter.

Radio communications for the Fire Service Crew whilst on board the helicopter will be provided by the helicopter crew.

Communications with the aircraft will only normally be available via VHF Marine wave band radio's. Crews operating on the ground, without assistance from a member of the aircraft's crew, should always maintain communications with the helicopter

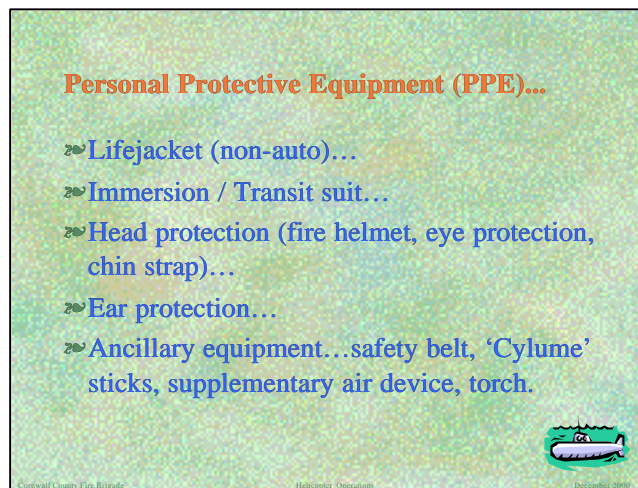

It is now decided that a coverall immersion suit meets the current and future needs. The suit plus undergarments giving thermal protection affords adequate protection to personnel. The combination of both satisfies SOLAS regulations and meets the requirements of CAA Specification 19.

Some Brigades wear fire resisting personnel protective equipment (PPE) as immersion suit undergarment, whilst other Brigades may carry firefighting PPE which is then donned on arrival.

Lifejacket

Lifejackets must be suitably approved to meet the standards required for airborne use *i.e non auto inflate (or the ability to 'disarm' auto inflate)*

Immersion / Transit Suits

Approved immersion suits for helicopter use are the *minimum* requirement for travelling by helicopter *and are to be worn at all times.*

Head Protection

A *Fire Brigade* helmet with chin strap fastening and built in visor is the minimum standard.

Ear Protection

Ear protection should be made available to all personnel.

Ancillary Equipment

All personnel should be afforded the appropriate level of personal protection and safety equipment which may include:

The provision of a supplementary air device.

Safety belt with pouch, personal line and karabiner.

Cylume chemical lights.(to be worn at night on board vessel)

Torch.

Welfare..

- ☛ Emergency rations e.g water, 'Hot Packs'...
- ☛ Anti nausea treatments, e.g, tablets, 'Seabands'...
- ☛ Emergency clothing packs...
- ☛ Personal 'holdalls'...
- ☛ Immigration provisions... 'we sometimes end up where we don't want to be'!!! (or do!!).

Cornwall County Fire Brigade Helicopter Operations December 2000

To be able to provide personnel with such equipment as they need to sustain them for a reasonable period of time offshore, should arrangements not be available on board the vessel / structure or standby vessel(s), welfare packs should be provided.

The exact nature of welfare packs is not stipulated, however, the following should be considered:

Hot Cans

Drinking Water

High Energy Bars

Toilet Paper

Face Wipes

Hand Cleaner

Sea Sickness pills / Seabands

Personnel who require to take seasickness tablets (*subject to advice from Brigade Occupational Health*) must ensure these are taken before embarkation (some tablets may cause drowsiness and this needs to be taken into account). Sea wrist bands provide some protection from seasickness and may be considered an alternative to seasick tablets.

All personal equipment and food could, if required, be carried in a personal holdall which the individual could retain during the flight and winching operation. This equipment must be limited in weight to the extent that it will not increase equipment levels beyond the maximum weight limits allowed for helicopter transport.

Consideration must also be given to immigration provision, where firefighters may land in a foreign country.

**‘SUPPORT’ Teams
Primary Objectives..**

- ☛ Normally maximum of 8 per team (airborne), and may be from supporting Fire Brigades...
- ☛ ...to support ‘response’ team as dictated by OC...
- ☛ ...to carry out ‘Offensive’ tactics...
- ☛ ...relieve previous crews.
- ☛ ...waterborne approach provides additional emergency egress, transportation of heavy equipment additional welfare facilities.

© Cornwall County Fire Brigade Helicopter Operations December 2000

When all assessments have been concluded the OC may take the decision that some Offensive tactics are necessary. Support teams will need to be mobilized to ensure these actions can be carried out with maximum safety and resource support.

Further resources may be committed via a seaborne transfer.

Support teams may be mobilised from supporting Brigades.

The OC must ensure that suitable, safe means of egress are available from the casualty for all those persons who will eventually be onboard. This may include the use of helo, standby vessels or the casualties own evacuation equipment.

Ultimately the number of personnel onboard the casualty will be down to local agreements

Composition

At the discretion of the OC in liaison with the IC (shorebased), taking into account the balance of need i.e personnel or equipment.

Any further equipment required by the Offshore team needs to be evaluated by the Operational Commander. He / she must be provided with the appropriate information so the correct assessment can be taken. This detail must be available for participating Brigades and carriers.

Account must be taken of helo carrying capacity.

Maximum payload of 2500lbs

Training for 'heliops'...

- ☛ Helo transfer - initial only...
- ☛ Sea survival training (Brigade approved course) - three yearly...
- ☛ Safety briefings and helo familiarisation - annual...
- ☛ Dry winching techniques - annually...
- ☛ Mutual aid / liaison joint training.

Corwall County Fire Brigade Helicopter Operations December 2000

Fire Brigades' investment in training and equipment is continuous and has resulted in an ability to rapidly airlift the reconnaissance team of nine firefighters to a stricken vessel and support it by sea borne approach. Such a provision requires a comprehensive training plan and, as with many Brigades, this plan is based on realistic training for firefighters and officers by the provision of exercises held annually involving all agencies such as Coastguard, Royal Navy, tug and ferry companies. The experience has shown that the demands of marine firefighting can only be met by firefighters who are both well trained and well equipped.

*The following is subject to local risk assessment.. and **requires further discussion.***

*Approved helicopter familiarisation / safety briefings. (Annually)
Sea Survival techniques - Brigade approved courses. (Three yearly)
Dry winching techniques. (Annually)
Helicopter transfer. (Initial only)*

Fire Brigades participating in offshore incidents that involve the use of helicopters as a primary mode of transport should carry out training with the appropriate 'carrier' and also with other key agencies e.g MCA and 'mutual assistance Brigades

Training should include testing of mobilising procedures, communication functions and the ability to respond to a request for mutual aid. Brigades must ensure that when mutual aid training is carried out, personnel are made aware of any relevant differences in command and control procedures, key equipment and communication systems



A red and white helicopter is shown in flight against a cloudy sky. The helicopter has "RESCUE" written on its side and the number "103" on the tail. The background shows a dark blue ocean and a horizon line.

MARINE OPERATIONS - 4

'Helicopter Operations'



Known declared response...



- Cornwall
 - Mid and West Wales
 - North Wales
 - Merseyside
 - Isle of Man
 - Lancashire
 - Northern Ireland
 - Highlands and Islands
 - Humberside
 - Lincolnshire
 - Suffolk
 - Kent
 - East Sussex
 - Isle of Wight
 - Hampshire
 - Guernsey
 - Jersey
- TOTAL ... 17

Response criteria...

- Request from MCA ...
- Request from another source that is approved and supported by the MCA...
- Must be approved by a Fire Brigade 'Principal' Officer - where there is an *immediate risk to life* or high risk of an incident developing that will have a *serious environmental impact*.

Teams...

'Assessment' Team:-

...team of two Officers only. Despatched when very limited information available...

'Strike' Team:-

...team of six, minimum. Despatched when immediate risk to life is known and / or suitable risk assessment has been achieved...

'Support' Teams:-

... as transport resources permit; to allow 'Offensive' tactics to be more suitably introduced.

'ASSESSMENT' TEAM...

Primary Objectives

- ① Provide first impression risk assessment information...
- ② Maintain communications links with MRCC...
- ③ Provide professional advice on matters relating to fire...
- ④ Formulate plan - if appropriate, advise Fire Brigade 'Principal' Officer (shoreside), to allow strategic decision making process...
- ⑤ Keep MRCC fully advised.

NOTE: This team 'may' be transported by air or sea

‘STRIKE’ TEAM (Airborne) - Composition - minimum of 6

- **‘Operations’ Commander [OC]**...Tactical decision maker...
- **‘Sector’ (or ‘Forward’) Commander**...second in command...
- **‘Command Support’**...to assist the OC, comms. etc...
- **Team Members (3)** ... ‘defensive’ tactics only.

The ‘Strike’ team may be the initial team and therefore will need to carry out the primary objectives of the ‘Assessment’ team before any further actions are taken.

(A waterborne ‘strike’ team may consist of up to 20 personnel (CCFB))

'STRIKE' TEAM...

Primary Objectives

- ① As dictated for 'Assessment' team ...
- ② Establish initial command point (ICP), normally the ship's bridge...
- ③ Consider a 'forward' command point (FCP)...
- ④ Initiate 'defensive' tactics and rescues...
- ⑤ Identify muster / evacuation point...
- ⑥ Continually risk assess, maintain good communications, brief and debrief all...
- ⑦ Consider further / mutual assistance.

MINIMUM LOAD FOR 'STRIKE' TEAM

~ Airborne ~

BAG 1

- ☺ Bag /box
- ☺ 2 x CABA sets
- ☺ BA boards
- ☺ Thermal image camera(TIC)
- ☺ First aid box
- ☺ 2 torches
- ☺ 2 x Marine band portable radios and spare batteries

Weight: 65kgs.

BAG 2

- ☺ Bag /box
- ☺ 2 x CABA sets
- ☺ 4 x handheld radios and waterproof covers.
- ☺ 4 torches
- ☺ Incident control board
- ☺ Transit line or guide tape

Weight: 61kgs.

BAG 3

- ☺ Bag /box
- ☺ 2 x CABA sets
- ☺ Welfare pack
- ☺ Field telephone
- ☺ Cable drum

Weight: 65kgs

TEAM of SIX: 600 kgs

TOTAL LOAD: < 800 kgs

Load bags...

Helicopter load bags should meet a minimum criteria for Manual Handling:-

- Maximum dimensions...
- Sling heights...
- Base specification...
- Method of clearly displaying contents...
- Identify SWL, be tested and recorded.

What is the aircraft's available payload?

Embarkation...

- Nominal roll completed...
- Safety brief...
eye, ear protection / aircraft approach / seating and
loading / disembarkation / emergency procedures...
- Illumination landing site.

PLAN OF HELICOPTER SEATING AND EQUIPMENT BAGS STOWAGE (R.N. Sea King Mk5.)

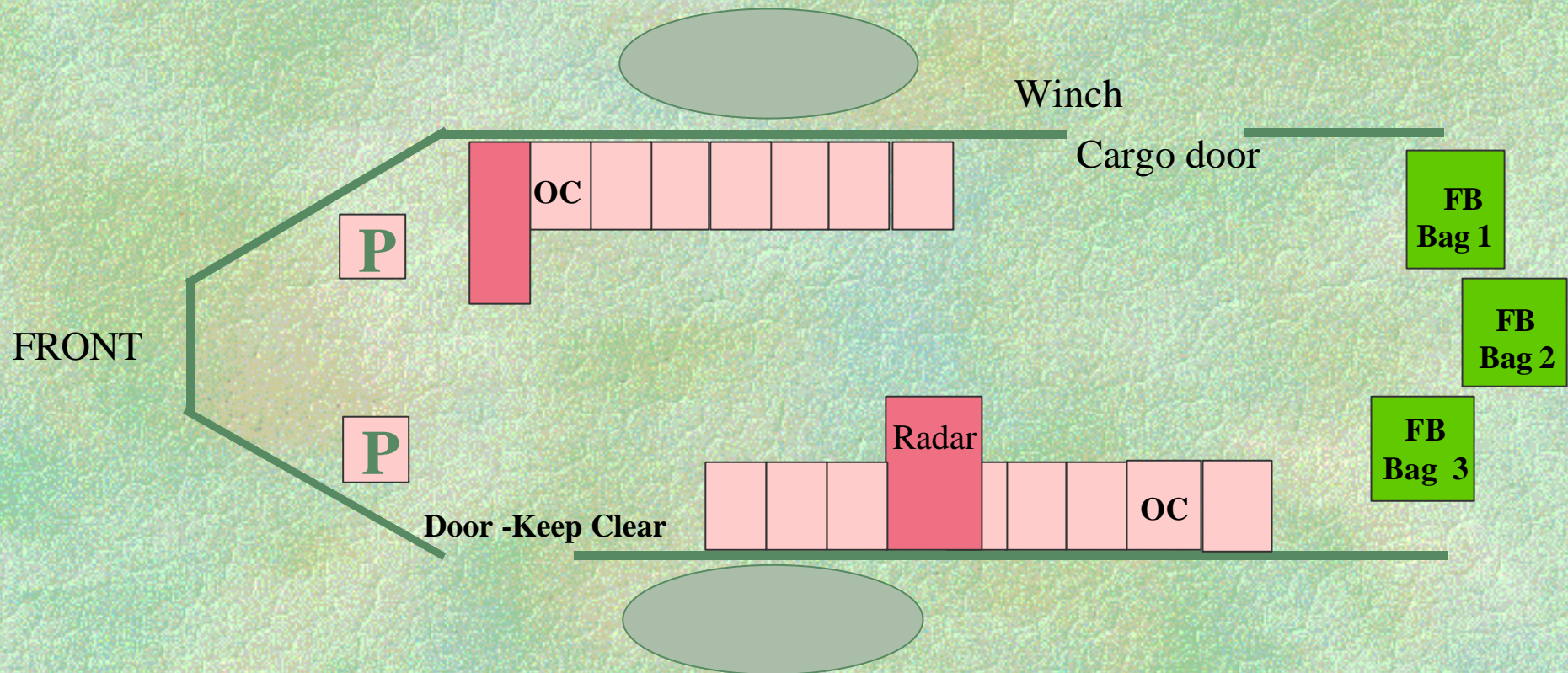

The Fire Brigade Operations Commander may be seated in either of the seats shown OC as determined by pilot. (The OC will be provided with a headset for comms.)

Equipment & Communications...

- ☛ Suitable equipment...
- ☛ Suitable PPE...
- ☛ Use of communications...
- ☛ Maintaining communications.

Personal Protective Equipment (PPE)...

- ☞ Lifejacket (non-auto)...
- ☞ Immersion / Transit suit...
- ☞ Head protection (fire helmet, eye protection, chin strap)...
- ☞ Ear protection...
- ☞ Ancillary equipment...safety belt, 'Cylume' sticks, supplementary air device, torch.



Welfare..

- ☛ Emergency rations e.g water, 'Hot Packs'...
- ☛ Anti nausea treatments, e.g, tablets, 'Seabands'...
- ☛ Emergency clothing packs...
- ☛ Personal 'holdalls'...
- ☛ Immigration provisions... 'we sometimes end up where we don't want to be'!!! (or do!!).

'SUPPORT' Teams Primary Objectives..

- ☛ Normally maximum of 8 per team (airborne), and may be from supporting Fire Brigades...
- ☛ ...to support 'response' team as dictated by OC...
- ☛ ...to carry out 'Offensive' tactics...
- ☛ ...relieve previous crews.
- ☛ ...waterborne approach provides additional emergency egress, transportation of heavy equipment additional welfare facilities.

Training for 'heliops'...

- Helo transfer - initial only...
- Sea survival training (Brigade approved course)
- three yearly...
- Safety briefings and helo familiarisation -
annual...
- Dry winching techniques - annually...
- Mutual aid / liaison joint training.

Summary...

The HELOSOP document was circulated last week. Your feed back is appreciated. Thank you for your attention.





The 'Marine Operations' packages are produced by CCFB Marine Operations Group (MOG) and are as follows

Part 1...Safe Working On Or Near Water...

Part 2...Offshore Incidents ~The Legal Framework

Part 3...Offshore Incidents ~Command and Control

Part 4...Helicopter Operations ~ SOP

Part 5...Tactical Ship Firefighting

Part 6...Ship construction.

Part 7...Sea Survival

Part 8...Small Boat Fire Safety

Other reference points include:-

ICS.ppt

Fire Service Manuals ~ Command and Control / Marine Operations...

DCOL's...

BIS Doc's...

Case Studies e.g 'Scandinavian Star'

CACFOA South West ICS packages

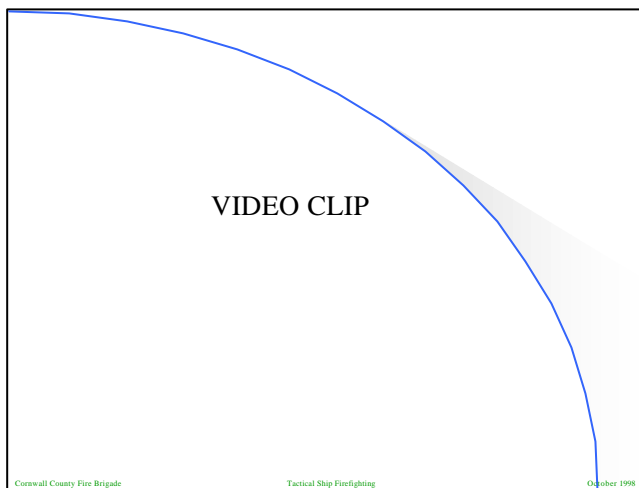

BIBLIOGRAPHY...

- Fire Service Manuals...
- BR 4007/94 RN Handbook on ship firefighting...
- DCOL 9/92...
- MSA publications...
- 'Fog Attack'..Paul Grimwood...
- Fundamentals of Fire..Giselsson...
- CCFB Incident Command lectures.

Corwall County Fire Brigade Tactical Ship Firefighting October 1998

Indicate MoF available..Book 4etc.

RN 'Orange' reference book .. show

DCOL9/92...All the training we are doing for ship ff.

Marine Safety Agency publications.

Fog Attack..tactical ff.

S.5...Points of safety...

AIM...

To provide students with an awareness of the tactical firefighting methods required, to satisfactorily deal with fires in sea going vessels.

Note:
When dealing with an incident offshore, the Incident Commander remains ashore. An Operational Commander is introduced to lead the offshore team as the Fire Commander.

The terminology therefore identified within this presentation should be read accordingly

Corwall County Fire Brigade Tactical Ship Firefighting October 1998

Self explanatory

S.3...Objectives...

OBJECTIVES...

- Command and Control procedures...
- Efficient use of water/foam...
- Hatch and door entry procedures...
- Effects of heat, humidity and stability...
- BA search procedures...
- Ventilation...
- Specialist equipment.

Cornwall County Fire Brigade Tactical Ship Firefighting October 1998

Emphasise each of the bullet points....

S.4...Bibliography...

Points of SAFETY...

- ❶ Always work in **PAIRS**...
- ❷ BA crews 'should' always be minimum of **THREE** Firefighters...
- ❸ Wear **LIFE-JACKET** if working on or near the water...
- ❹ Monitor movement of people on and off the vessel...
- ❺ Ensure ALL persons understand evacuation whistle and '**Safeguard**'.

Corwall County Fire Brigade Tactical Ship Firefighting October 1998

Emphasise dangers onboard ships, trip hazards etc.

BA crews, increased numbers improve safety.

Lj's..if going below leave with BAECO or OIC, but wear when working near ships side.

S.6..Role of the incident commander.....

NOTE - Fixed installations...

- *Are they available?*
- *Have they been used?*
- *Can they be re-used?*
- *Are they necessary?*

The 'OC' must evaluate all these issues.

Carbon Dioxide...
Halon...
Foam...
Water...
Steam.

Corwall County Fire Brigade Tactical Ship Firefighting October 1998

Identify the problems of each e.g BA within these areas, alarms, change in environment.

Can they be recharged.

Do they cover the appropriate areas..

Sprinklers/ multi sprays...stability and drainage.

23 Foams..

NOTE: Lifejackets

Unless working on or near the water ,
lifejackets should be removed and
located at the boarding point / or
equipment area.

If working on weather decks, lifejackets
must be worn.

Incident / Operational Commander (OC)...

- The 'Tactical' decision maker...
- Must NOT become directly involved with operations...
- Must ensure Risk Assessment and special hazards are adequately addressed...
- Must nominate 'Command Support' ...
- Should nominate 'Safety Officer's' and ensure safety of ALL personnel...
- Maintain close liaison with 'ships master' and make use of 'ship's' personnel...

Corwall County Fire Brigade Tactical Ship Firefighting October 1998

A vessel is a most hazardous place the OIC needs to be fully briefed by a RESPONSIBLE person before committing crews.

He must decide on the appropriate ext. media, entry points, safe use of support and attack parties. Communications. Are rescues required and if so are they achievable?

Is it safe to commit crews, or have the ships crew contained the fire. have the fixed installations been operated, are they available.

Are there any particular hazards he needs to consider

S.7...Command support...

and...

- obtain ships plans and if possible use Bridge or ship control centre [SCC/HQ1]
- ascertain the Class and size of fire...
- use the appropriate extinguishing medium...
- instigate reconnaissance and containment...
- identify the method of approach , dependent on the relevant 'tactical' mode i.e. **Defensive** - **Transitional** - **Offensive**
- Nominate 'key' personnel..

Click to return to MOG1

Cornwall County Fire Brigade Tactical Ship Firefighting October 1998

A vessel is a most hazardous place the OIC needs to be fully briefed by a RESPONSIBLE person before committing crews.

He must decide on the appropriate ext. media, entry points, safe use of support and attack parties. Communications. Are rescues required and if so are they achievable?

Is it safe to commit crews, or have the ships crew contained the fire. have the fixed installations been operated, are they available.

Are there any particular hazards he needs to consider

S.7...Command support...

Safety Officer's

- Must have a constant awareness of the environment and the changes which take place during an incident...
- Take necessary urgent action to avoid injuries...
- Continually monitor and ensure Command Team advised and updated...
- Actions must be recorded.

Command Support

IC / OC MUST nominate an individual as Command Support....

At 4 pumps or over this will be the Command Support Vehicle [CSV] Officer..

He /she will....

Support the IC / OC...

Advise Fire Control of Tactical mode...

Make written records.

'Forward' or 'Sector' Commander

Responsible to the IC /OC for the tactical role of the 'attack' party.

There may be more than one Sector Commander and this must be taken into account with regards use of radio communications and committing crews into a scene of operations

Corwall County Fire Brigade Tactical Ship Firefighting October 1998

Self explanatory..being based on the West Yorkshire command system

9...Crews roles...

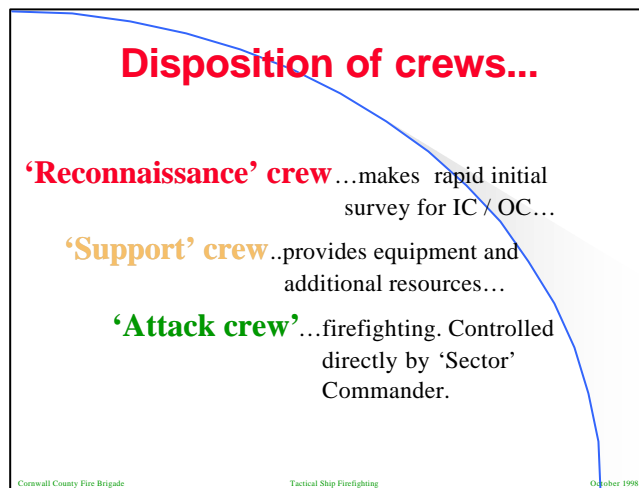

Explain briefly that three key teams need to be instigated.as follows.

S 10 Recon team..

'RECONNAISSANCE' CREW...

- Initial briefing by IC / OC - work in pairs...
- Make use of ship's plans...
- Check for signs of fire [using TIC.s and 'Hotspotters'] ...
- Avoid opening affected compartments...
- Check all six sides [if possible]...
- Report back to Commander.

Corwall County Fire Brigade Tactical Ship Firefighting October 1998

Emphasise all the above and if able to check all six sides ensure the OIC receives all the information.

Use comms. beware of screening, be aware of ships comms. systems and note where the OIC is located ..you may wish to phone him!!

S.11...Support crew...

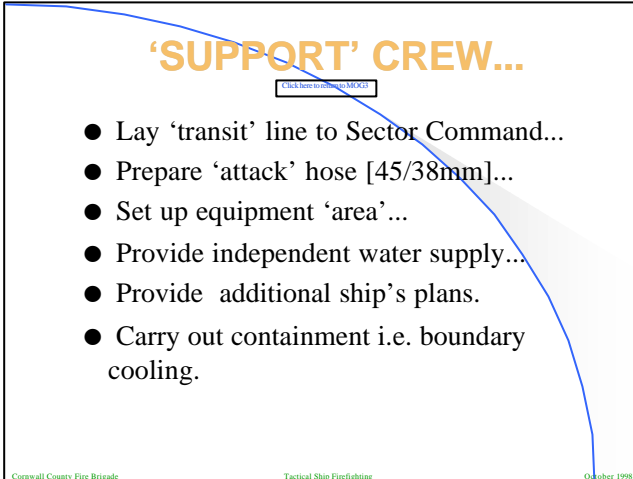

'SUPPORT' CREW...

- Lay 'transit' line to Sector Command...
- Prepare 'attack' hose [45/38mm]...
- Set up equipment 'area'...
- Provide independent water supply...
- Provide additional ship's plans.
- Carry out containment i.e. boundary cooling.

Click here to return to slide 10

Corwall County Fire Brigade Tactical Ship Firefighting October 1998

Initially equipment dump on upper deck[pre determined kit]. Also provide kit at forward bridgehead for attack party...as req'd by OIC.Run 'guide' [8mm conspic. line]line from access point on upper deck to for'd bridgehead.

Lay out required hose for attack party.

Once initial work done provide indepen. water supply i.e. port.pp.

Run 'hard comms. wire to ford bh. Prepare to carry out boundary starv./cool.

S.12...Boundary starvation/cooling...

**'CONTAINMENT'-
and achieving it...**

- Work in pairs.
- Boundary 'STARVE' first...
- Boundary 'COOL' all six sides...
- Use sprays...
- Locate bulkhead thermometers...

PREVENTS SPREAD

STOPS STRUCTURAL FAILURE

REDUCES INTERNAL TEMPERATURE

Cornwall County Fire Brigade Tactical Ship Firefighting October 1998

Starvation...removing combustibles from adjacent compartments..no starve..no cool properly.

Boundary cool all six sides if possible to completely contain fire.

Do Not work alone.

Sprays use less water,wider coverage and prevents localised cooling leading to structural failure.

S.13... FORWARD COMMAND...

Resources at 'Forward' Command ..

- Ship's plans...
- Communications; including hard wire to CSV...
- Suitable branch and adequate hose to reach fire...
- Equipment i.e.. TIC, water, writing instruments, first aid kit, branch shut off valves....
- Two BA boards for ECO, two guide lines, cleaning materials, spare radio, 'Snaplights'...
- Illumination, shelter, place of safety - means of egress.

Corwall County Fire Brigade Tactical Ship Firefighting October 1998

SELF EXPLANATORY

14..but where does it go...

BA Entry Control Officer [ECO]...

- Managed by 'Sector' Commander...
- Tight control of BA comms..their may be other ECO's!!..
- Ensure BA teams of THREE...
- Liase with BA Main Control...
- 'Snaplights' worn by team leader to identify team ...
- Obtain 'boarding' tallies if in use and attach to BA tally.

Corwall County Fire Brigade Tactical Ship Firefighting October 1998

Consider the role of EPM or For. Comm to take the 'weight' off the baco.

Use of Snaplights and communications

Teams should not be wearing boarding tallies. Attach to BA tally if they are.

the awareness and problems of other BACO.s I.e. comms etc..

16 Attack crew...

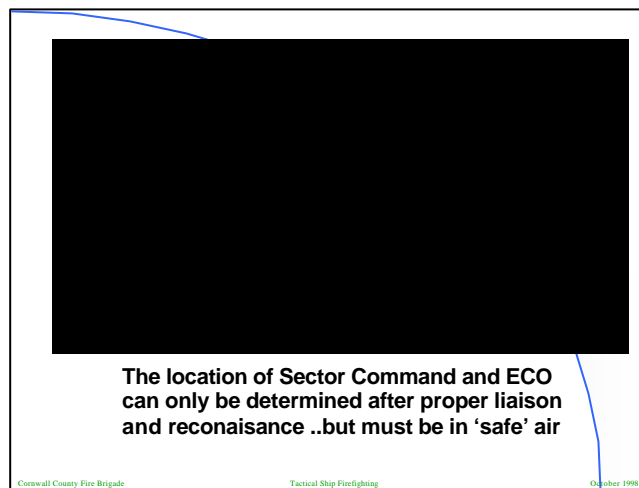

Discuss options..no hard and fast rules. Discuss guide lines and withdrawal and the associated problems

15...BACO...

'ATTACK' CREWS...

- Team of THREE...
- Communications ...
- Consider use of TIC...
- Briefing by 'Sector' Commander...
- Don BA in 'CLEAN/SAFE' air...
- Try to maintain smoke boundary...
- Take in adequate hose...

Cornwall County Fire Brigade Tactical Ship Firefighting October 1998

CLEAN/SAFE air are synonymous, but be aware of having the 'bridgehead' jeopardised when doors/hatches are open. What do do if BAECO etc.. has to withdraw. Consider using salvage sheets to set up a smoke boundary.

Crews must be properly briefed..use ships plan.

Comms/TIC are essential. TIC may 'white out' ..but will spot a fire in a compartment.

Feed in hose..ensure adequate before entry.

Carry out correct ff. procedures i.e.. water walls.

S.17...continued...Where to locate...

...and...

- Search pattern...
- Keep low and be aware of the high potential for Flashover and / or Backdraft...
- Hatch and Door entry...
- Use ship structure for protection but beware of hot metal work...
- Use water on what you SEE and TOUCH, because...

Corwall County Fire Brigade Tactical Ship Firefighting October 1998

Dont deal with fires i.e.. direct ff, if other crews are working in area..communicate!

Rescues,use of progressive vent. Search patterns..Briefing..backs to ladders then left/right..

When going through doors and hatches,if a fire is suspected..defensive ff. To be demonstrated later. **BEWARE OF FO/BD.**Lack of signs and symptoms because of compartmentation

Use ships structure for protection. **SHUT** doors .

Use water sensibly and on what you touch, to cool, and what you see..ff because....

S.18...Water... .

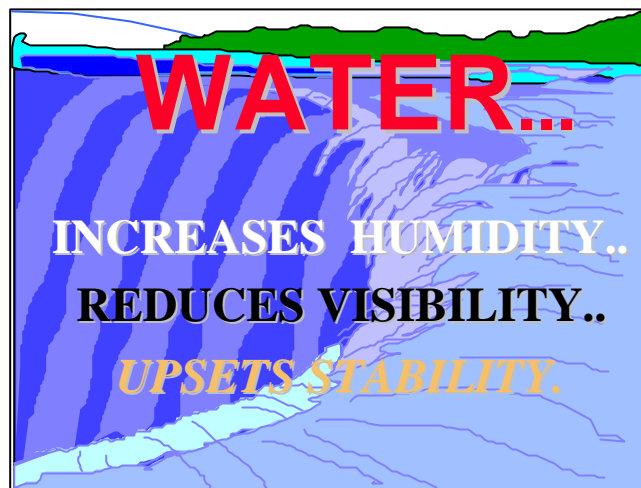

Self explanatory.....humidity worsens working conditions.

Steam produced reduces visibility and scolds.

Too much water will eventually upset stability..

19.. entering compartments Be aware of...



Very important. Scalding other crews if jets used etc.

Always debrief by forward /sector commanders.

20 Be aware of...

'Safety - Safety - Safety'

Click here to return to MOG

- **Door / hatch entry...**
- **use of 'water walls'...**
- **'Gas cooling'...**
- **'Indirect / Direct' branch attack...**
- **Realise your limitations...**
- **Continually risk assess...**
- **Protect your egress.**

Corwall County Fire Brigade Tactical Ship Firefighting October 1998

EVACUATION...

- Boarding procedures...
- Good briefing / Communication...
- 'Safeguard' rule...
- Use of gangways...
- Use of 'whistle'.
- Protect all crews...
- Controlled i.e.. Tactical Withdrawal...

Cornwall County Fire Brigade Tactical Ship Firefighting October 1998

Safe evac. in an emergency relies on good briefing and comms. with crews.

If an emerg. arises **SAFEGUARD** should be transmitted to gain radio silence. Then the BAECO or BASC needs to Tac. With. crews from greatest point of danger. Other crews protecting their egress if necessary. Also take the hose line back..you may need it!

The use of the whistle **MAY** put crews in danger by calling everybody out..in the wrong sequence.Ensure **ALL** personnel are aware of whistle.

29 Fire out....

S.20..Fire out...

TACTICAL WITHDRAWAL

‘The controlled evacuation of personnel from a risk area to a place of safety’ as defined in DCOL 5/1994.

Consider:-

Briefings / communications and liaison with ALL personnel.

Phased evacuation...

Protect crews...

Cornwall County Fire Brigade

Tactical Ship Firefighting

October 1998

A phased evacuation carried out to ensure safety of all crews...relies heavily on pre entry briefing and good communications both with crews inside and other EPMs etc outside.

The Tac. With. takes time and great control. Crews may need to protect their own egress ie returning with jets etc. Strict controls on radio are required for this to succeed .

Slide ..19...Evacuation considerations.....

Evacuation / Withdrawal considerations...

- Crew briefing and communication...
- Accurate records kept...
- Use of 'whistle'..beware!...
- 'SAFEGUARD' procedure'...
- ECO/ 'Sector Commander' liaison...
- OC / SC to instigate 'appropriate' procedure.

Cornwall County Fire Brigade

Tactical Ship Firefighting

October 1998

To safety 'evacuate' or 'tactically withdraw' from within a building the above must be adhered to.

The whistle COULD jeopardise safety, be aware.

To obtain radio silence the term SAFEGUARD should be repeated THREE times then the necessary instructions issued to give a greater degree of control of wearers.

Liaison between all concerned is of paramount importance to ensure a successful outcome.

Slide 20... What may instigate an evacuation?...

What may instigate an evacuation?...

- A Command decision...
- Unsafe structure...
- Sounding of the 'whistle'...
- Communications 'failure'.

Cornwall County Fire Brigade

Tactical Ship Firefighting

October 1998

Self explanatory...

AND...

Slide 21...Operation of a DSU...

All personnel need to be aware of :...

- Sudden ships movement...
- Use of BA guide lines...
- Hose couplings/submerged hose...
- Firemain bulkhead valves...
- Fixed systems i.e. comms / sounds...
- Automatic watertight / fire doors...
- Pressure waves.

Cornwall County Fire Brigade Tactical Ship Firefighting October 1998

Guidelines can be cut by violent movement of ships doors. Good comms. in case bridgehead has to 'retire'..

Hose etc..

Valves know what is available and where.

Pressure waves when opening doors and hatches compartment pressurised for various reasons..and sudden ships movements may catch people and cargo off guard!

Auto doors can be operated from bridge!

21...teams of three...

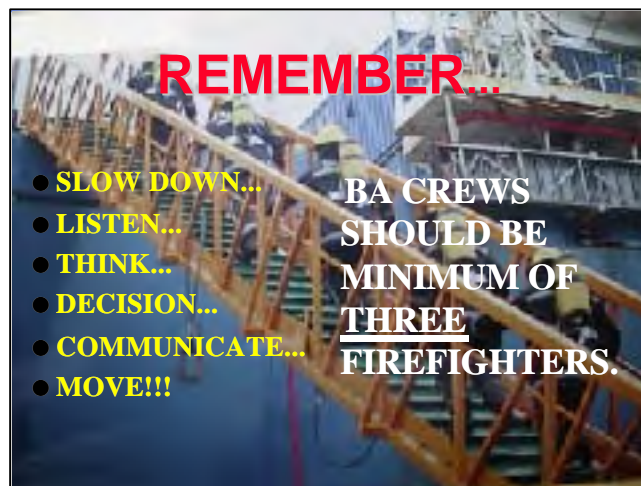

Self explanatory

22 Fixed installations

THE USE OF FOAM...

- Hi-ex, medium or low...
- Machinery space fires...
- Tanks...
- Bulk cargo...
- Use of foam branches with shut - off valves...
- Supporting jets /sprays and ventilation.

Cornwall County Fire Brigade Tactical Ship Firefighting October 1998

Foam must always be taken into any mach.space fire, with water wall protection.Low/medium/high expansion foams can also be used in tanks and on bulk cargo.

Shut off vv's for FB225's

Prove foam prior to proceeding and entry into compartment.

Beware of problems with hi - ex ,vents,covering jets etc.

S.24...Ventilation...

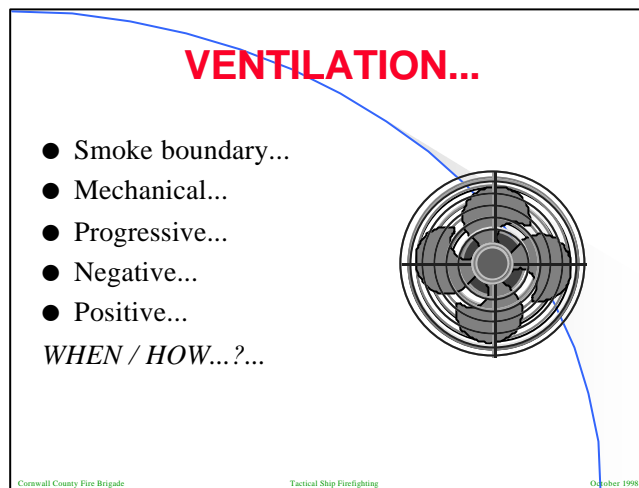

Set up smoke boundaries..doors/curtains.

Can ships vent extract be used to move / contain smoke or are fans [portable] going to have to be introduced.

Systematic/Progressive...working through venting as team proceeds[natural]

Neg./ Pos...depends on type of fan being used and where and if it can be located.

S.25...When to ventilate..

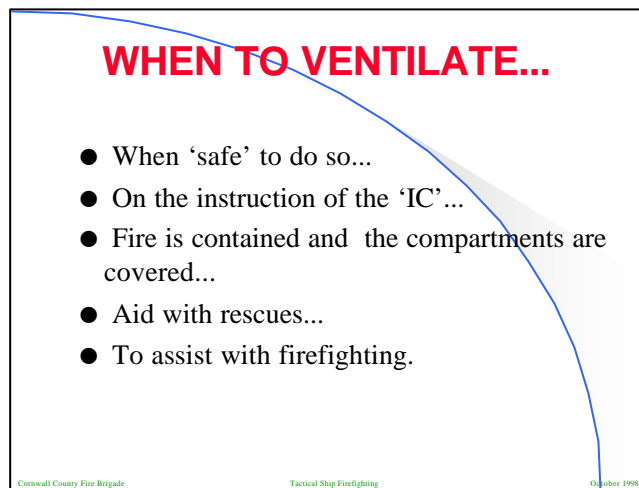

SAFE..not increase fire spread/not jeopardise crew safety.

OIC to liaise with ships Officer..

Adequately contained and covering sprays at vent points..

Systematic/progressive 'natural' venting may assist with rescues ie clear room.. vent...close down room...move on.

Assist ff. but with care in unaffected areas.

S.26 How to ventilate...

HOW TO VENTILATE...

- Top or lateral...
- Protect crews...
- Communicate.
- Make use of prevailing winds...
- Use ships structure...
- Covering sprays...
- Only make openings when necessary.

Cornwall County Fire Brigade Tactical Ship Firefighting October 1998

Explain each ..the next slide shows progressive and can be used to highlight each...

27 Progressive ventilation...

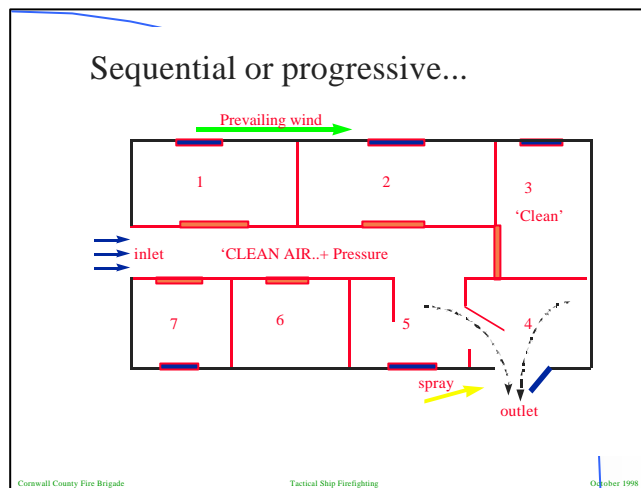

Explain the various options including the use of fans, sprays etc

28 Evacuation...

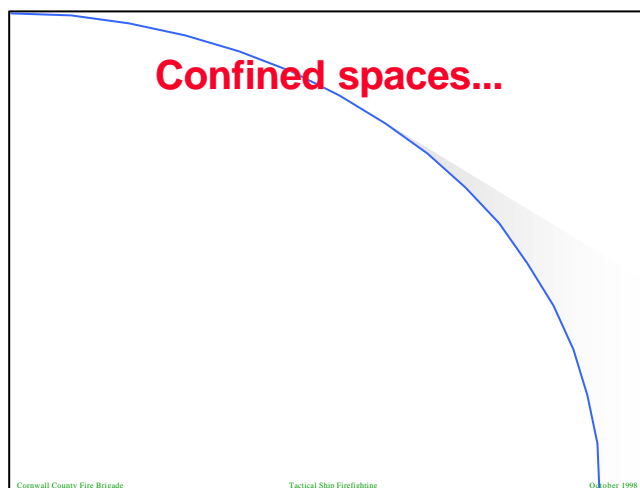

SUMMARY...

- Information and liaison...
- Briefing and debriefing...
- Tactical mode i.e **Defensive** / **Transitional** / **Offensive** firefighting...
- Fixed installations...
- Reconnaissance, Support and Attack crews...
- Heat / Humidity / Stability...

Cornwall County Fire Brigade Tactical Ship Firefighting October 1998

Pre planning..visit ships or obtain plans if they are regular visitors.At incident obtain good info. and set up liaison with responsible ships Officer.

Obtain all info. on fixed inst. etc...

Ensure everybody is briefed ..

Ff/ ventilation/HHS..must all be taken account of/

Consider how and where the crews will work and with whom ie ships crew.

31...summary continued..

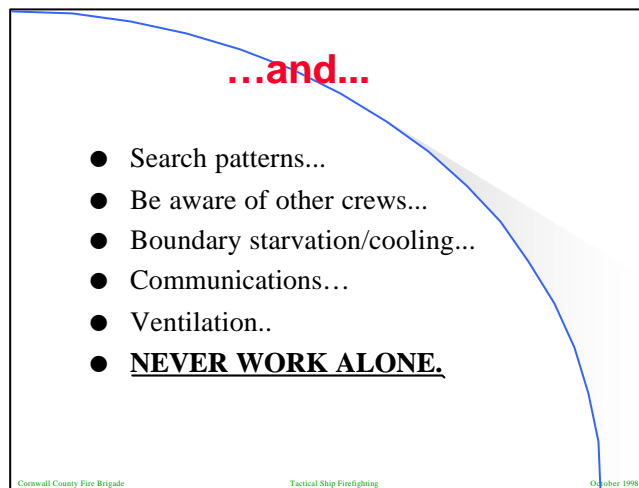

Searching..briefing..bums to the ladders..

Beware of other crews when Ff.

Bound.St/Cool at early stage..

Good comms inc hard wire

Never allow personnel to work alone aboard a ship.

LAST SLIDE... Do not become a casualty!!!!.



MARINE OPERATIONS - 5

Tactical Ship Firefighting





VIDEO CLIP

BIBLIOGRAPHY...

- Fire Service Manuals...
- BR 4007/94 RN Handbook on ship firefighting...
- DCOL 9/92...
- MSA publications...
- 'Fog Attack'..Paul Grimwood...
- Fundamentals of Fire..Giselsson...
- CCFB Incident Command lectures.

AIM...

To provide students with an awareness of the tactical firefighting methods required, to satisfactorily deal with fires in sea going vessels.

Note:

When dealing with an incident offshore, the Incident Commander remains ashore. An Operational Commander is introduced to lead the offshore teams as the Fire Commander.

The terminology therefore identified within this presentation should be read accordingly

OBJECTIVES...

- Command and Control procedures...
- Efficient use of water/foam...
- Hatch and door entry procedures...
- Effects of heat, humidity and stability...
- BA search procedures...
- Ventilation...
- Specialist equipment.

Points of SAFETY...

- ① Always work in **PAIRS**...
- ② BA crews 'should' always be minimum of **THREE** Firefighters...
- ③ Wear **LIFE-JACKET** if working on or near the water...
- ③ Monitor movement of people on and off the vessel...
- ④ Ensure ALL persons understand evacuation whistle and '**Safeguard**'.

NOTE - Fixed installations...

- *Are they available?*
- *Have they been used?*
- *Can they be re-used?*
- *Are they necessary?*
The 'OC' must evaluate all these issues.

Carbon Dioxide...

Halon...

Foam...

Water...

Steam.

NOTE: Lifejackets

Unless working on or near the water ,
lifejackets should be removed and
located at the boarding point / or
equipment area.

If working on weather decks, lifejackets
must be worn.

Incident / Operational Commander (OC)...

- The 'Tactical' decision maker...
- Must NOT become directly involved with operations...
- Must ensure Risk Assessment and special hazards are adequately addressed...
- Must nominate 'Command Support'...
- Should nominate 'Safety Officer's' and ensure safety of ALL personnel...
- Maintain close liaison with 'ships master' and make use of 'ship's' personnel...

and...

- obtain ships plans and if possible use Bridge or ship control centre [SCC/HQ1]
- ascertain the Class and size of fire...
- use the appropriate extinguishing medium...
- instigate reconnaissance and containment...
- identify the method of approach , dependent on the relevant 'tactical' mode i.e. **Defensive** - **Transitional** - **Offensive**
- Nominate 'key' personnel..

[Click to return to MOG3](#)

Safety Officer's

- Must have a constant awareness of the environment and the changes which take place during an incident...
- Take necessary urgent action to avoid injuries...
- Continually monitor and ensure Command Team advised and updated...
- Actions must be recorded.

Command Support

IC / OC MUST nominate an individual as Command Support....

At 4 pumps or over this will be the Command Support Vehicle [CSV] Officer..

He /she will....

Support the IC / OC...

Advise Fire Control of Tactical mode...

Make written records.

'Forward' or 'Sector' Commander

Responsible to the IC /OC for the tactical role of the 'attack' party.

There may be more than one Sector Commander and this must be taken into account with regards use of radio communications and committing crews into a scene of operations

Disposition of crews...

‘Reconnaissance’ crew...makes rapid initial survey for IC / OC...

‘Support’ crew..provides equipment and additional resources...

‘Attack crew’...firefighting. Controlled directly by ‘Sector’ Commander.

'RECONNAISSANCE' CREW...

- Initial briefing by IC / OC - work in pairs...
- Make use of ship's plans...
- Check for signs of fire [using TIC.s and 'Hotspotters'] ...
- Avoid opening affected compartments...
- Check all six sides [if possible]...
- Report back to Commander.

'SUPPORT' CREW...

[Click here to return to MOG3](#)

- Lay 'transit' line to Sector Command...
- Prepare 'attack' hose [45/38mm]...
- Set up equipment 'area' ...
- Provide independent water supply...
- Provide additional ship's plans.
- Carry out containment i.e. boundary cooling.

'CONTAINMENT'- and achieving it...

- Work in pairs.
- Boundary 'STARVE' first...
- Boundary 'COOL' all six sides...
- Use sprays...
- Locate bulkhead thermometers...

PREVENTS SPREAD

**STOPS STRUCTURAL
FAILURE**

**REDUCES INTERNAL
TEMPERATURE**

Resources at 'Forward' Command ..

- Ship's plans...
- Communications; including hard wire to CSV...
- Suitable branch and adequate hose to reach fire...
- Equipment i.e.. TIC, water, writing instruments, first aid kit, branch shut off valves....
- Two BA boards for ECO, two guide lines, cleaning materials, spare radio, 'Snaplights'...
- Illumination, shelter, place of safety - means of egress.

BA Entry Control Officer [ECO]...

- Managed by 'Sector' Commander...
- Tight control of BA comms..their may be other ECO's!!..
- Ensure BA teams of THREE...
- Liase with BA Main Control...
- 'Snaplights' worn by team leader to identify team ...
- Obtain 'boarding' tallies if in use and attach to BA tally.



**The location of Sector Command and ECO
can only be determined after proper liaison
and reconaissance ..but must be in 'safe' air**

'ATTACK' CREWS...

- Team of THREE...
- Communications ...
- Consider use of TIC...
- Briefing by 'Sector' Commander...
- Don BA in 'CLEAN/SAFE' air...
- Try to maintain smoke boundary...
- Take in adequate hose...

...and...

- Search pattern...
- Keep low and be aware of the high potential for Flashover and / or Backdraft...
- Hatch and Door entry...
- Use ship structure for protection but beware of hot metal work...
- Use water on what you SEE and TOUCH, because...

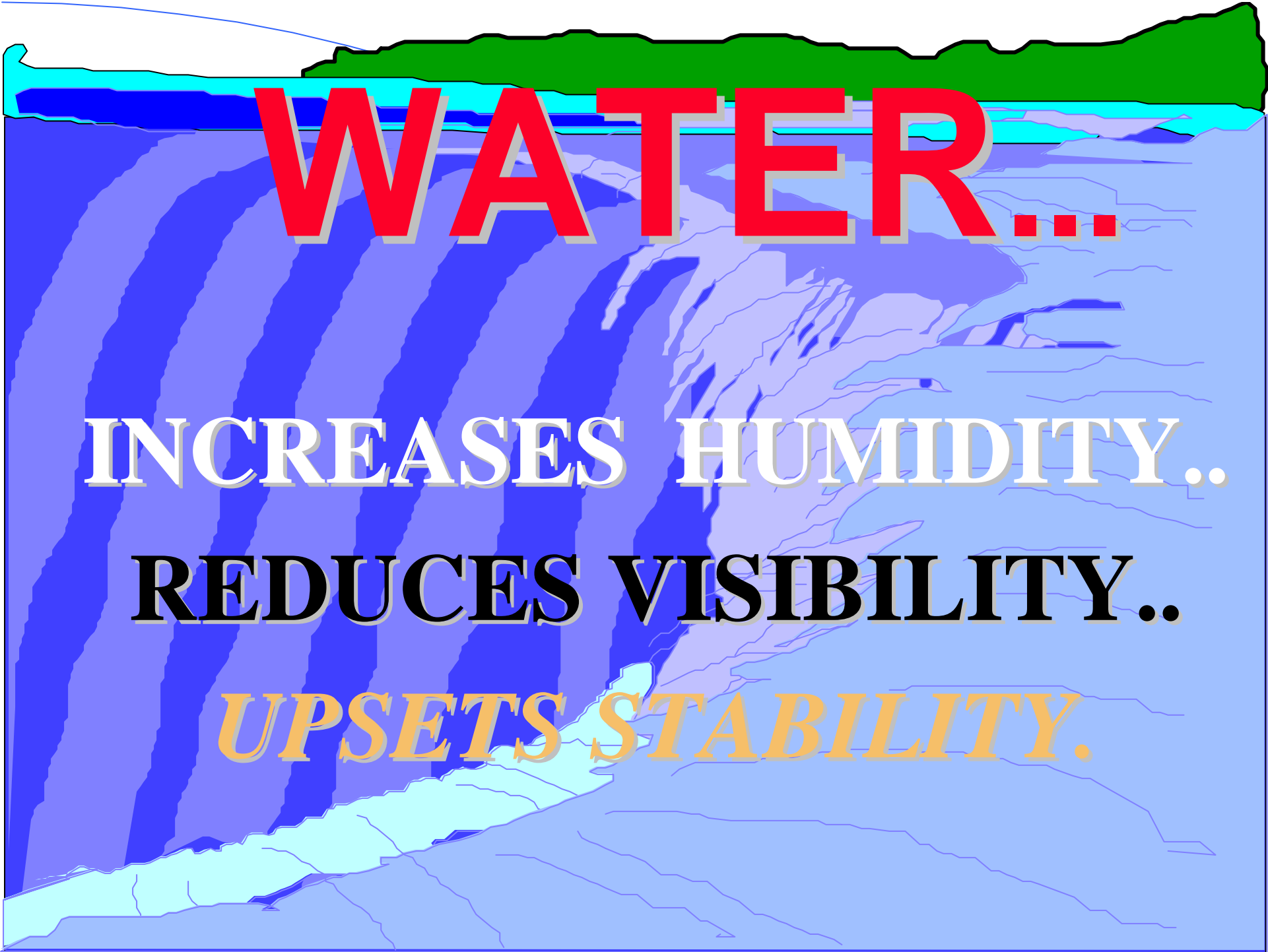

WATER....

INCREASES HUMIDITY..

REDUCES VISIBILITY..

UPSETS STABILITY.

'Attack' crew, remember...

When entering DOWN into a compartment,
allow all of team to reach deck level
before carrying out firefighting...or
else!!!

Be aware of - and communicate with other
crews within the compartment - the
'Sector Command' - each other!
and THINK...

'Safety - Safety - Safety'

[Click here to return to MOG3](#)

- **Door / hatch entry...**
- **use of 'water walls'...**
 - **'Gas cooling'...**
- **'Indirect / Direct' branch attack...**
 - **Realise your limitations...**
 - **Continually risk assess...**
 - **Protect your egress.**

EVACUATION...

- Boarding procedures...
- Good briefing / Communication...
- ‘Safeguard’ rule...
- Use of gangways...
- Use of ‘whistle’.
- Protect all crews...
- Controlled i.e.. Tactical Withdrawal...

TACTICAL WITHDRAWAL

‘The controlled evacuation of personnel from a risk area to a place of safety’ as defined in DCOL 5/1994.

Consider:-

Briefings / communications and liaison with ALL personnel.

Phased evacuation...

Protect crews...

Evacuation / Withdrawal considerations...

- Crew briefing and communication...
- Accurate records kept...
- Use of 'whistle'..beware!...
- **'SAFEGUARD'** procedure' ...
- ECO/ 'Sector Commander' liaison...
- OC / SC to instigate 'appropriate' procedure.

What may instigate an evacuation?...

- A Command decision...
- Unsafe structure...
- Sounding of the 'whistle'...
- Communications 'failure'.

All personnel need to be aware of :...

- Sudden ships movement...
- Use of BA guide lines...
- Hose couplings/submerged hose...
- Firemain bulkhead valves...
- Fixed systems i.e. comms / sounds...
- Automatic watertight / fire doors...
- Pressure waves.

A photograph of several firefighters in full gear, including helmets and jackets, positioned on a wooden aerial ladder. They are at a construction site, with a building's steel framework visible in the background. The scene is set against a clear sky. The text 'REMEMBER...' is overlaid in large red letters at the top of the image.

REMEMBER...

- **SLOW DOWN...**
- **LISTEN...**
- **THINK...**
- **DECISION...**
- **COMMUNICATE...**
- **MOVE!!!**

**BA CREWS
SHOULD BE
MINIMUM OF
THREE
FIREFIGHTERS.**

THE USE OF FOAM...

- Hi-ex, medium or low...
- Machinery space fires...
- Tanks...
- Bulk cargo...
- Use of foam branches with shut - off valves...
- Supporting jets /sprays and ventilation.

VENTILATION...

- Smoke boundary...
- Mechanical...
- Progressive...
- Negative...
- Positive...

WHEN / HOW...?...

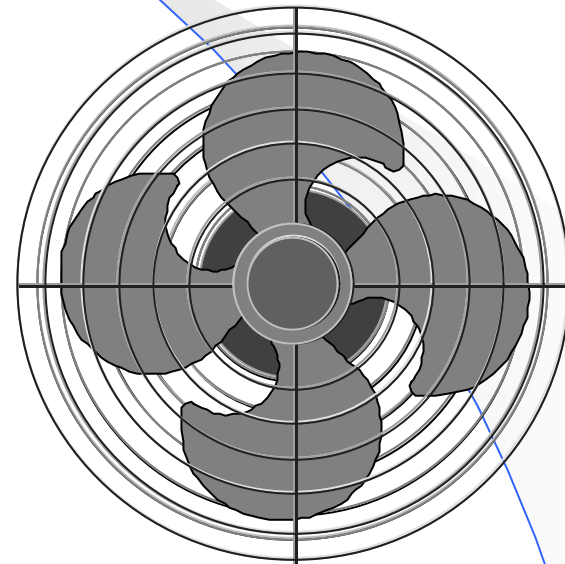

WHEN TO VENTILATE...

- When 'safe' to do so...
- On the instruction of the 'IC'...
- Fire is contained and the compartments are covered...
- Aid with rescues...
- To assist with firefighting.

HOW TO VENTILATE...

- Top or lateral...
- Protect crews...
- Communicate.
- Make use of prevailing winds...
- Use ships structure...
- Covering sprays...
- Only make openings when necessary.

Sequential or progressive...

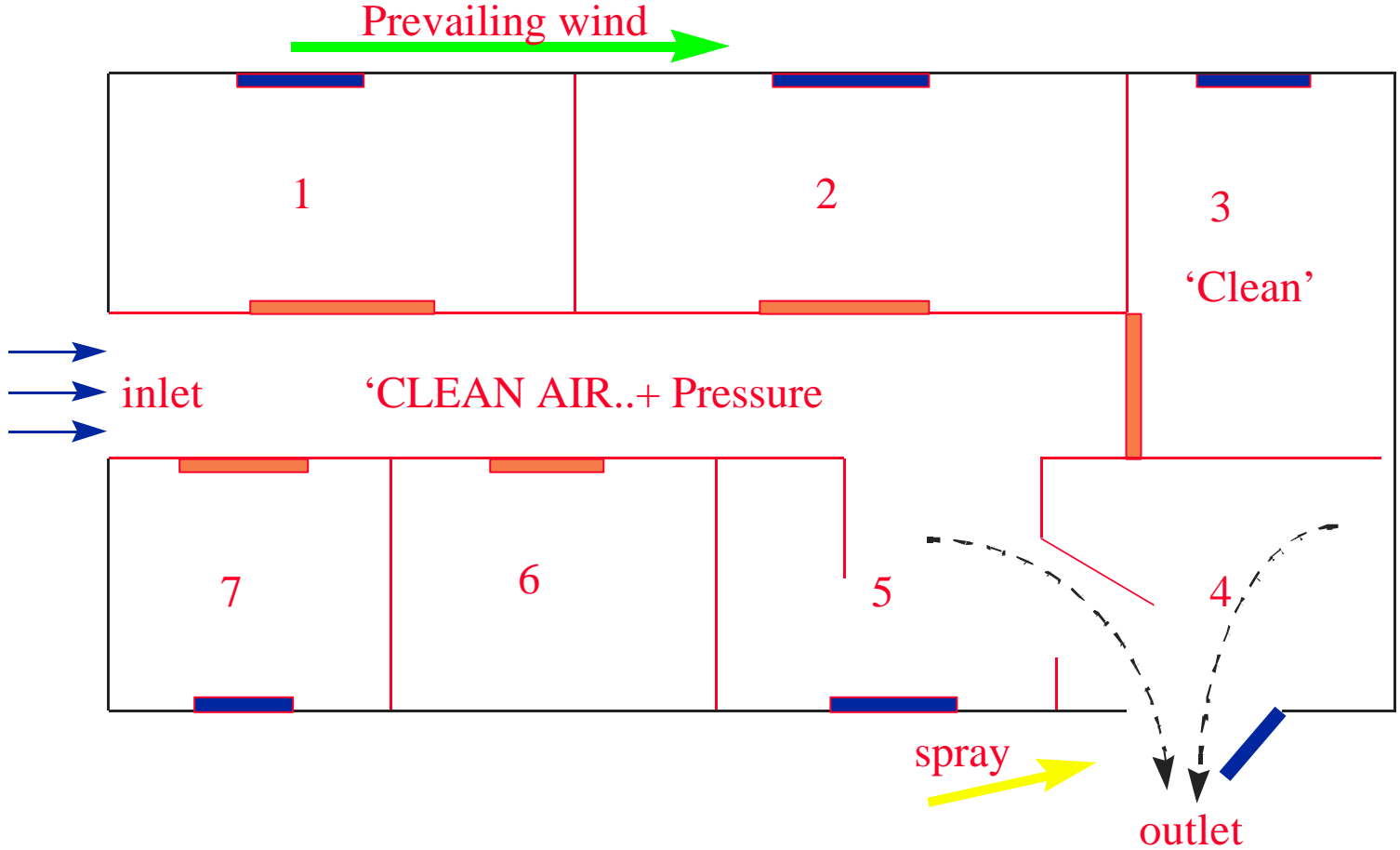

Confined spaces...

SUMMARY...

- Information and liaison...
- Briefing and debriefing...
- Tactical mode i.e **Defensive** / **Transitional** / **Offensive** firefighting...
- Fixed installations...
- Reconnaissance, Support and Attack crews...
- Heat / Humidity / Stability...

...and...

- Search patterns...
- Be aware of other crews...
- Boundary starvation/cooling...
- Communications...
- Ventilation..
- **NEVER WORK ALONE.**

..and don't become a casualty!!!



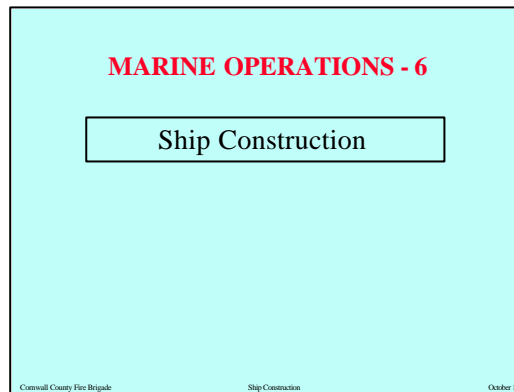

The 'Marine Operations' packages are produced by CCFB Marine Operations Group (MOG) and are as follows

Part 1...Safe Working On Or Near Water...

Part 2...Offshore Incidents ~The Legal Framework

Part 3...Offshore Incidents ~Command and Control

Part 4...Helicopter Operations ~ SOP

Part 5...Tactical Ship Firefighting

Part 6...Ship construction.

Part 7...Sea Survival

Part 8...Small Boat Fire Safety

Other reference points include:-

ICS.ppt

Fire Service Manuals ~ Command and Control / Marine Operations...

DCOL's...

BIS Doc's...

Case Studies e.g 'Scandinavian Star'

CACFOA South West ICS packages

Aim...

To give you a brief insight into the types of vessels and basic construction of these vessels.

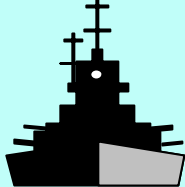

Corvallis County Fire Brigade Ship Construction October 1998

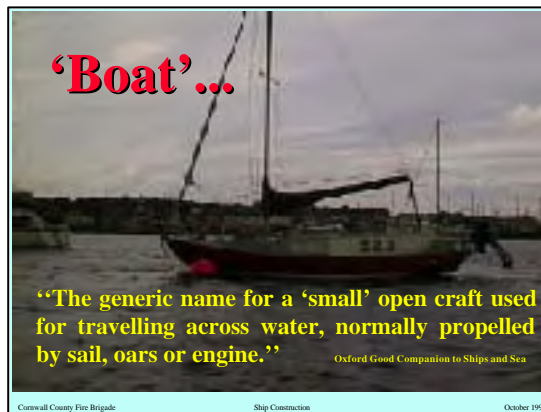

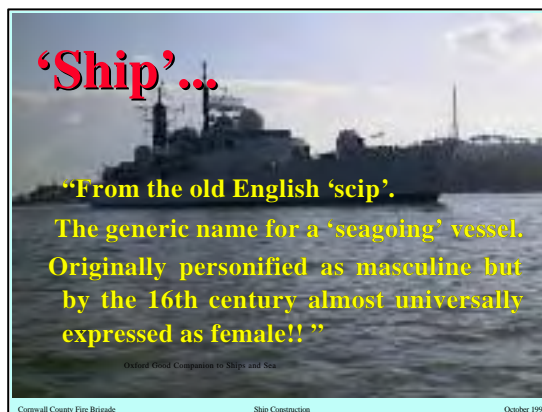

Safety of life at sea...

- **SOLAS Convention**
Chapter 2/2..Fire protection >500tons
Chapter 7 HAZMATS
- **International Maritime Organisation**
[IMO]- 140 member states
- **Classification Societies** - e.g... Lloyds
Register of Shipping [LR]

Conwall County Fire Brigade

Ship Construction

October 1998

Some common nautical terms...

[See also Book 4- Manual of Firemanship]

- WATER / FUEL... ..*BALLAST.*
- DOWNSTAIRS... ..*BELOW.*
- WALL... ..*BULKHEAD.*
- OIL / GRAIN / ETC... ..*BULK CARGO.*
- WHERE THE DRIVER SITS... ..*BRIDGE.*
- LOW PART OF THE HULL... ..*BILGE.*
- FLOOR... ..*DECK.*
- CEILING... ..*DECKHEAD.*
- KITCHEN... ..*GALLEY.*
- TOILET... ..*HEADS.*
- CARGO LIST... ..*MANIFEST.*
- DRAIN... ..*SCUPPER.*
- 'SIDE' PILOT DOOR... ..*SHELL DOOR.*
- UPPER DECK... ..*UP TOP.*
- OPEN CONTINUOUS DECK... ..*WEATHER DECK.*



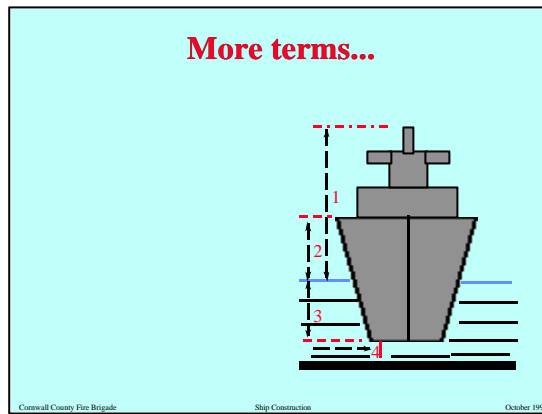

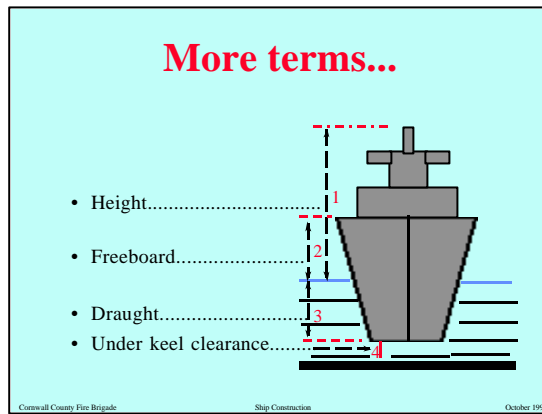

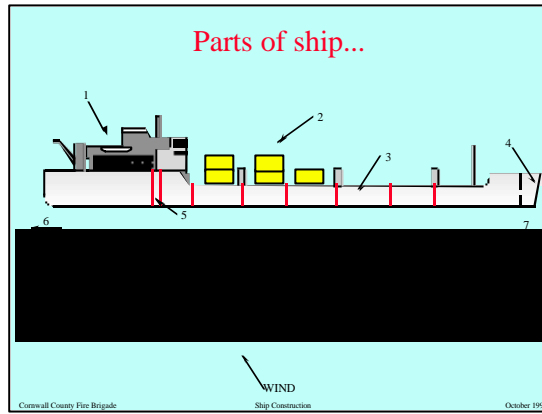

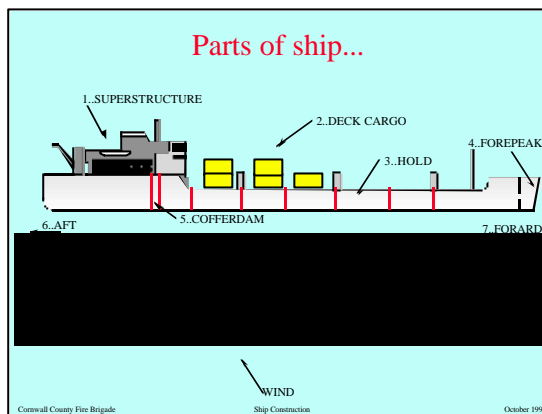

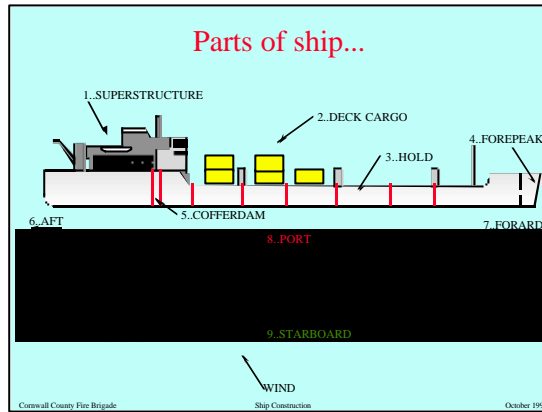

Fire separation...

- **Class A** construction - 60 min.FR [integrity / stability..not insulation]. Primary structure i.e.. main decks, transverse and longitudinal bulkheads [and fittings]..
- **Class B** construction - 30 min.FR [as Class A] Non primary structure i.e.. corridors, cabins etc.....
- **Class C** construction - non combustible e.g.. cabin partition...
- **Class F** - fishing vessels.

Contraill County Fire Brigade

Ship Construction

October 1998

**Means of Escape - very similar to
'shoreside, for example..**

- Limited dead ends, protected 'shafts', alternative exits...
- 'Atria' design etc.....
- Watertight doors -weight, control, angle of heel..
- Smoke control, fire alarms, emergency lighting.

Contraill County Fire Brigade

Ship Construction

October 1998

Types of passenger vessels...

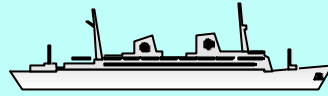

- **Liners..** 'Oriana' / QE2 etc....
- **Ferries..** 'Scandinavian Star' / 'Herald of Free Enterprise' / 'Torpoint'...
- **Cruise ships..** 'Romantica' / 'Carnival Ecstasy'...
- **River cruisers..** 'Marchioness'.

Construction 'problems' on passenger ships...

- Large areas i.e. atria, restaurants etc....
- Dead ends, long passageways...
- Surface finishes and decor...
- Alcohol!!!...
- Disorientation...
- Passive / active Fire safety measures..
- Large numbers of people...

Corwall County Fire Brigade

Ship Construction

October 1998

Finding your way around....

- Deck names...
- Deck numbers...
- Deck letters...
- Start high - work low!!!
- Start low - work high!



Connetquot County Fire Brigade Ship Construction October 1998

Ro - Ro / Container ships...

- Cargo / passenger ships...
- Vehicles...
- Containers - above and below decks...
- Mixed cargoes...
- HAZMATS - IMDG Codes...
- Confined spaces...

Confined spaces...

- Air spaces...
- Double bottoms [DB's]...
- Deep tanks...
- Cofferdams...
- Twin hulls.

Remember.....Confined Space Regulations 1998

Hazardous materials [HAZMAT's]

- Containers of HAZMATs should be upper deck cargo, clearly identified on ships manifest...
- Norfolk 1991, two containers of 'Lindane' on beach!!..
- All ships have some form of HAZMAT e.g. fridge gases, tank fumes etc..

Corwall County Fire Brigade

Ship Construction

October 1998

Tankers...

- **Crude** - Larger tanks, less pipework, [from field to refinery]...
- **Product** - Smaller tanks, more pipework etc., various products [refinery to end user]...
- **OBO** - Ore / Bulk / Oil...
- **Gas** - Methane, butane, etc....

Corwall County Fire Brigade

Ship Construction

October 1998

Tanker tonnage...

- **LCC** - Large Crude Carrier
100,000 to 200,000 tonnes dw...
- **VLCC** - Very Large Crude Carrier
200 to 400,000 tonnes dw...
- **ULCC** - Ultra Large Crude Carrier
400,000 plus, tonnes dw...
- **Dead-weight tonnage**..is the 'carrying' capacity of the vessel [her earning power]...
[**Gross tonnage**.. 'cargo' space .Dry cargo and passenger ships only]

Corwall County Fire Brigade

Ship Construction

October 1998



Corvallis County Fire Brigade

Ship Construction

October 1998

Summary

- Ships and boats...
- Terminology...
- Types of craft...
- Fire separation...
- Topography...
- Cargoes...
- Confined spaces...

Why is a ship called 'She'?...

...because there is always a great deal of bustle around her.

There is usually a gang of men around her.

She has a 'beam' and 'stays' and it takes considerable paint to keep her in 'trim'.

It takes an experienced man to handle her correctly; and without a man at the helm she is uncontrollable!

She displays her 'topsides', hides her 'bottom' and, when entering port always heads for the buoys after crossing the 'bar'!!!

Corvallis County Fire Brigade

Ship Construction

October 1998

MARINE OPERATIONS - 6

Ship Construction

Aim...

To give you a brief insight into the types of vessels and basic construction of these vessels.

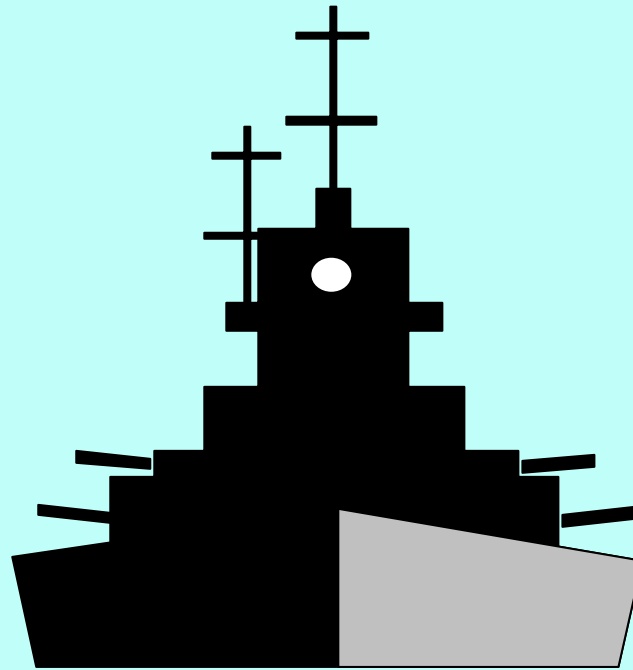

‘Boat’...

“The generic name for a ‘small’ open craft used for travelling across water, normally propelled by sail, oars or engine.”

Oxford Good Companion to Ships and Sea

‘Ship’...

“From the old English ‘scip’.

**The generic name for a ‘seagoing’ vessel.
Originally personified as masculine but
by the 16th century almost universally
expressed as female!! ”**

Oxford Good Companion to Ships and Sea

Safety of life at sea...

- **SOLAS Convention**

Chapter 2/2..Fire protection >500tons

Chapter 7 HAZMATs

- **International Maritime Organisation**

[IMO]- 140 member states

- **Classification Societies** - e.g... Lloyds

Register of Shipping [LR]

Some common nautical terms...

[See also Book 4 - Manual of Firemanship]

- WATER / FUEL... ..*BALLAST.*
- DOWNSTAIRS... ..*BELOW.*
- WALL... ..*BULKHEAD.*
- OIL / GRAIN / ETC... ..*BULK CARGO.*
- WHERE THE DRIVER SITS... ..*BRIDGE.*
- LOW PART OF THE HULL... ..*BILGE.*
- FLOOR... ..*DECK.*
- CEILING... ..*DECKHEAD.*
- KITCHEN... ..*GALLEY.*
- TOILET... ..*HEADS.*
- CARGO LIST... ..*MANIFEST.*
- DRAIN... ..*SCUPPER.*
- 'SIDE' PILOT DOOR... ..*SHELL DOOR.*
- UPPER DECK... ..*UP TOP.*
- OPEN CONTINUOUS DECK... ..*WEATHER DECK.*

and...The Golden Rivet!! - ask a Stoker!!!

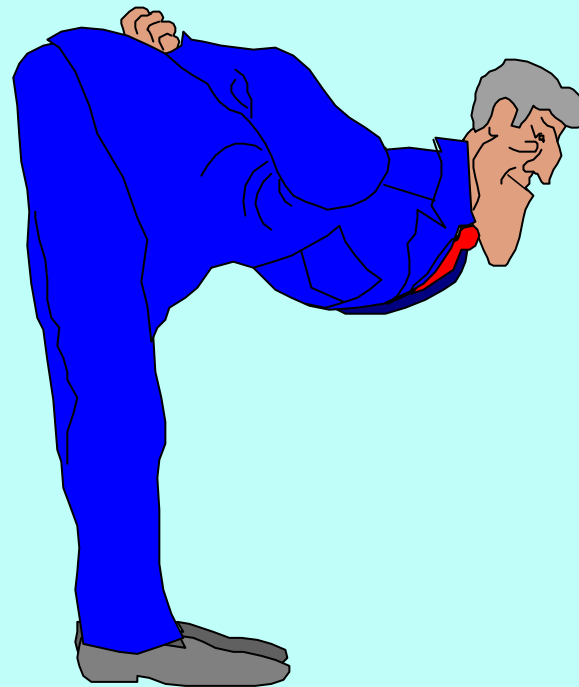
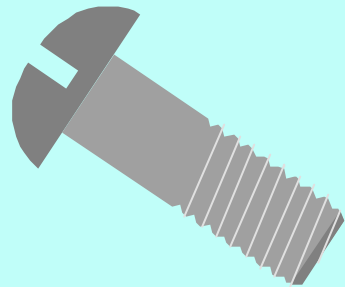

More terms...

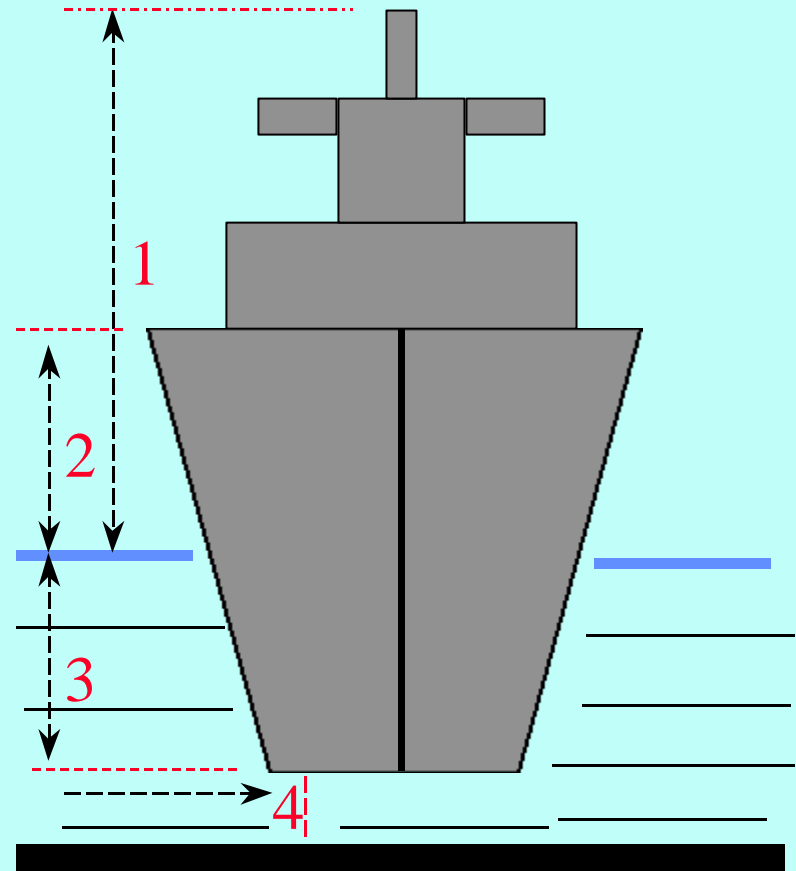

More terms...

- Height.....
- Freeboard.....
- Draught.....
- Under keel clearance.....

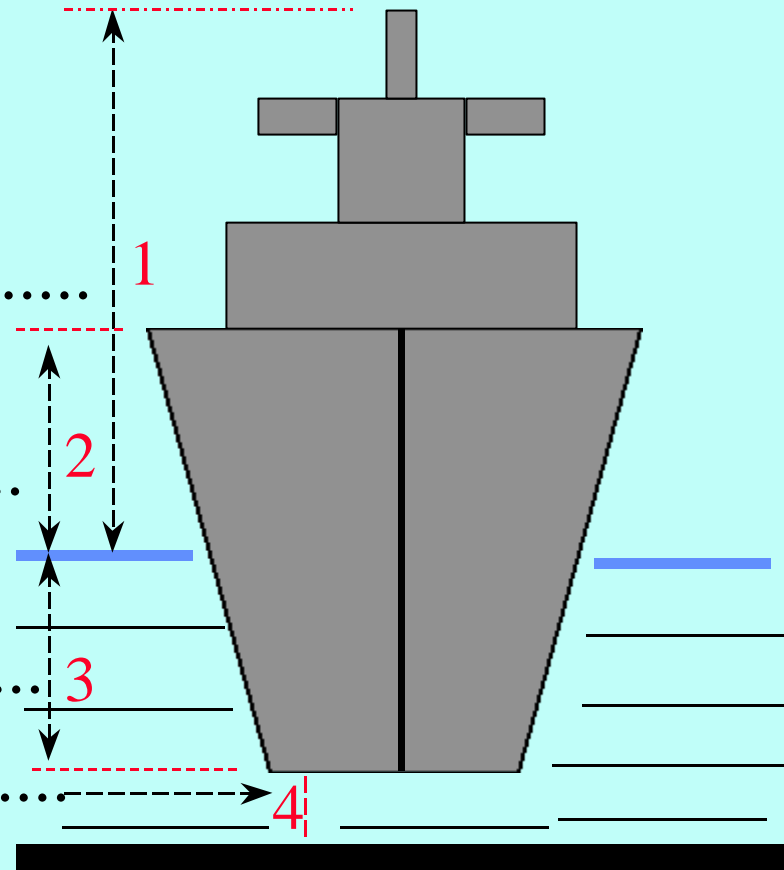

Parts of ship...

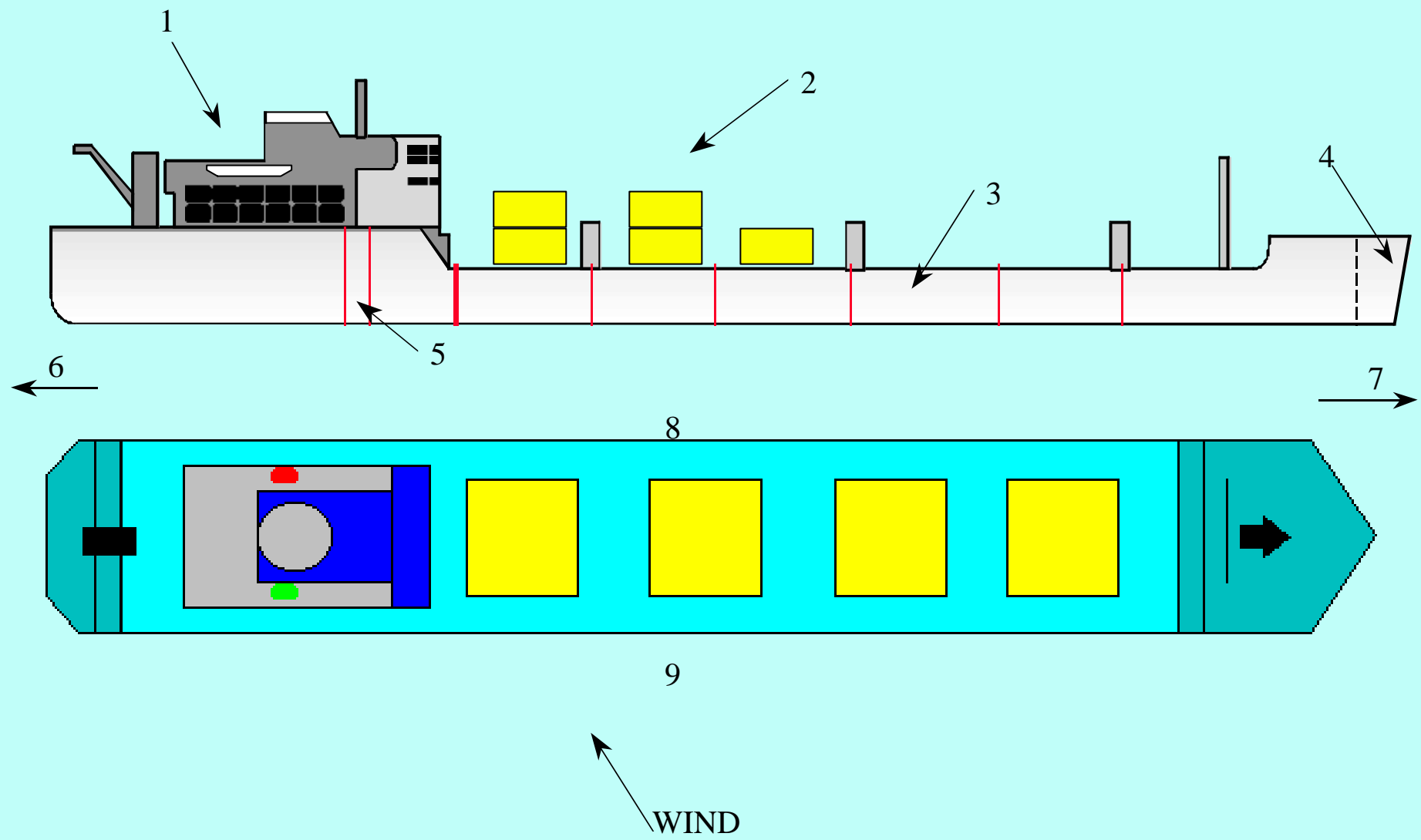

Parts of ship...

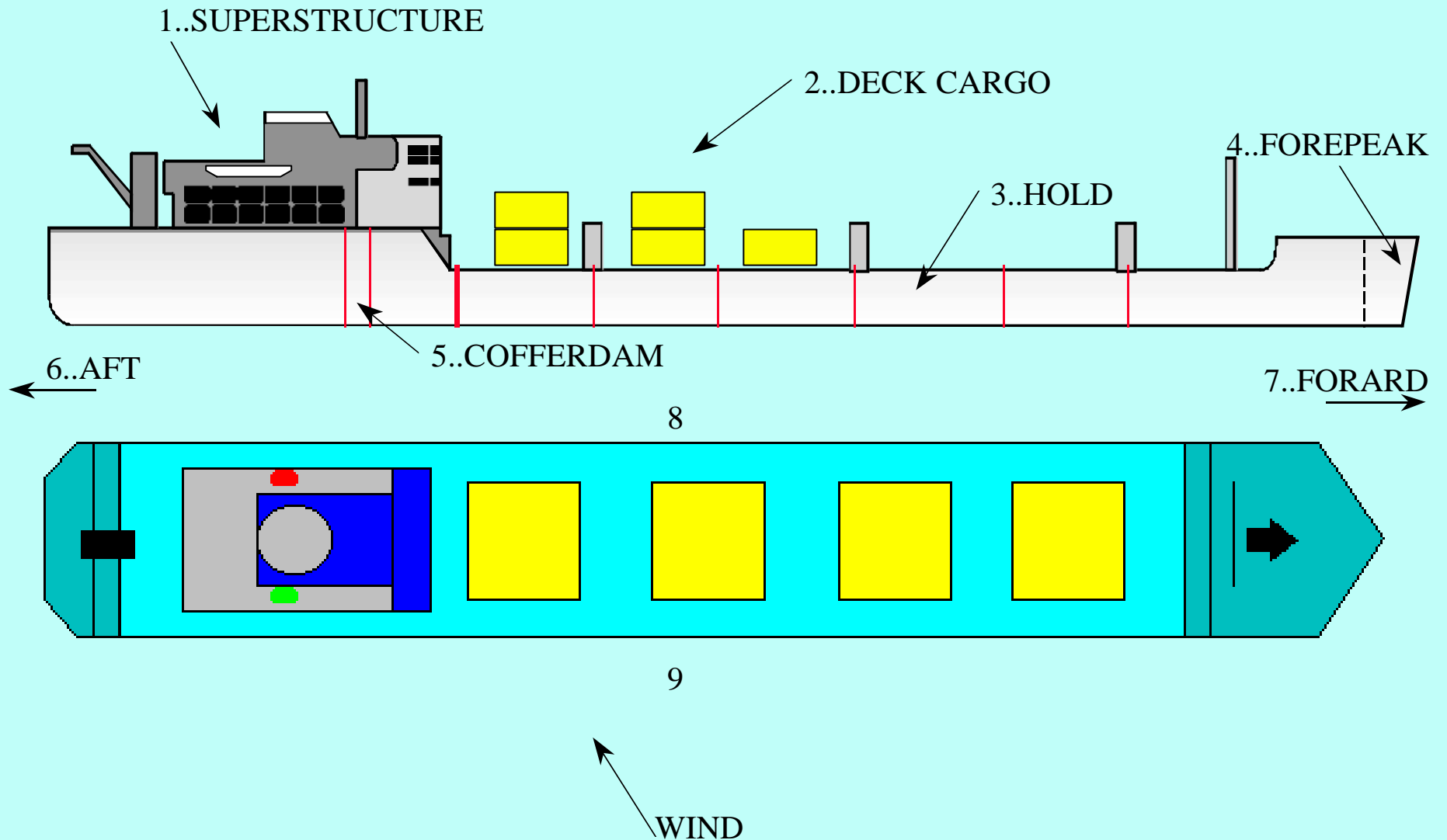

Parts of ship...

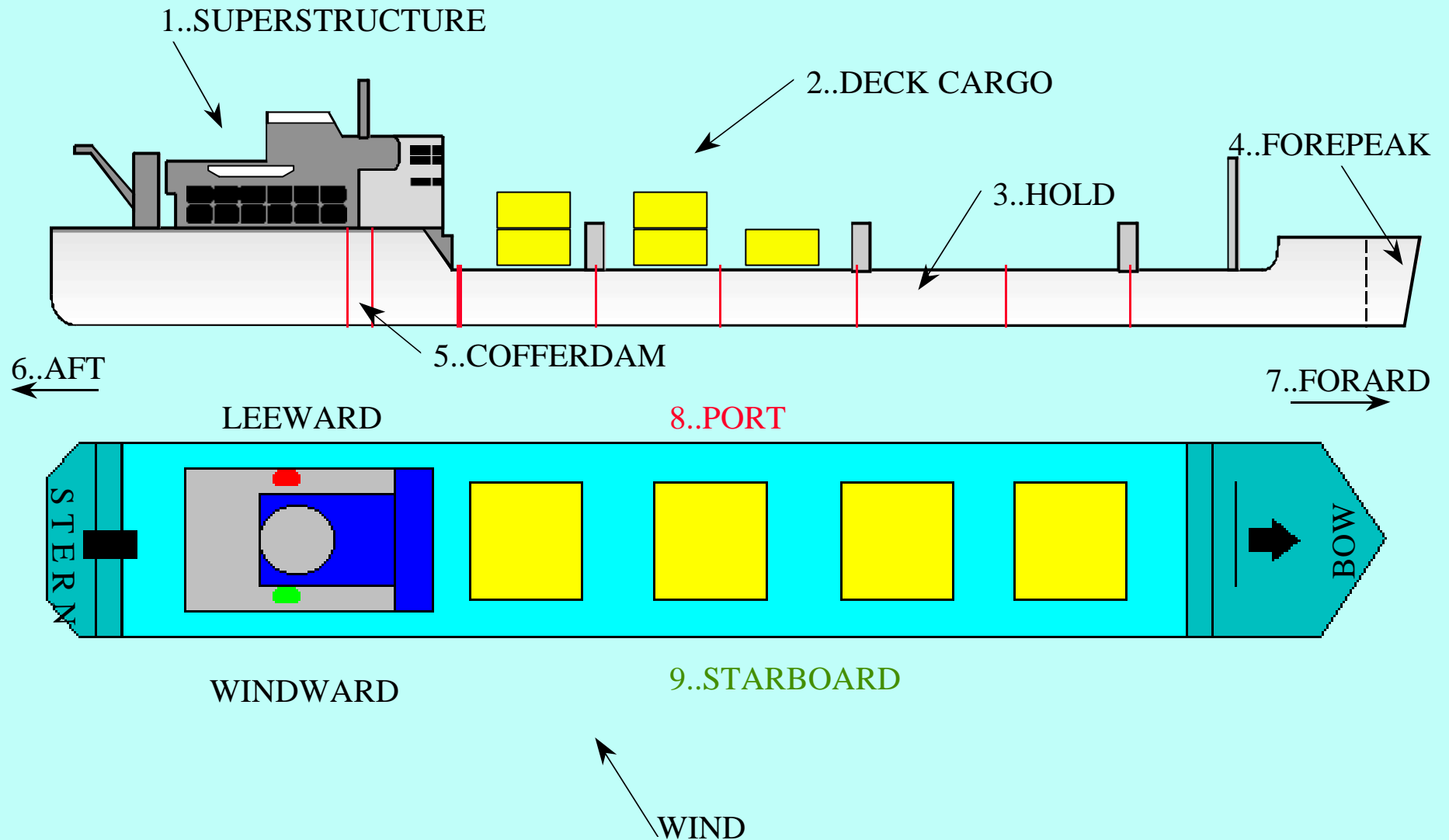

Fire separation...

- Class A construction - 60 min.FR [integrity / stability..not insulation]. Primary structure i.e.. main decks, transverse and longitudinal bulkheads [and fittings]...
- Class B construction - 30 min.FR [as Class A] Non primary structure i.e.. corridors, cabins etc.....
- Class C construction - non combustible e.g.. cabin partition...
- Class F - fishing vessels.

Means of Escape - very similar to 'shoreside, for example..

- Limited dead ends, protected 'shafts', alternative exits...
- 'Atria' design etc.....
- Watertight doors -weight, control, angle of heel..
- Smoke control, fire alarms, emergency lighting.

Types of passenger vessels...

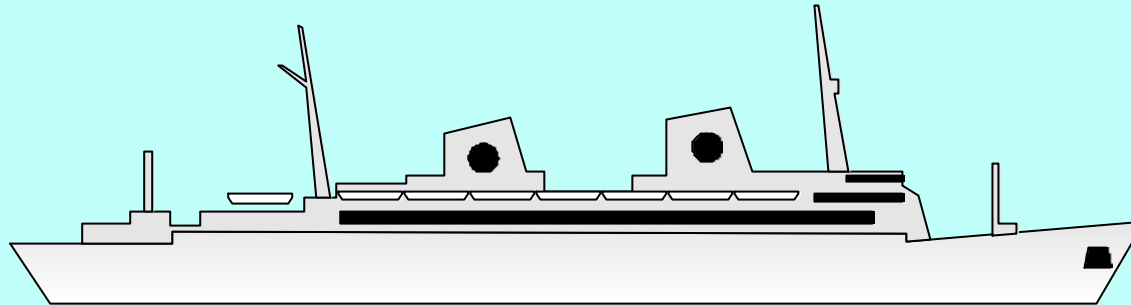

- **Liners..** ‘Oriana’ / QE2 etc....
- Ferries.. ‘Scandinavian Star’ / ‘Herald of Free Enterprise’ / ‘Torpoint’...
- **Cruise ships..** ‘Romantica’ / ‘Carnival Ecstasy’...
- **River cruisers..** ‘Marchioness’.

Construction 'problems' on passenger ships...

- Large areas i.e. atria, restaurants etc....
- Dead ends, long passageways...
- Surface finishes and decor...
- Alcohol!!!...
- Disorientation...
- Passive / active Fire safety measures..
- Large numbers of people...

Finding your way around....

- Deck names...
- Deck numbers...
- Deck letters...
- Start high - work low!!!
- Start low - work high!



Ro - Ro / Container ships...

- Cargo / passenger ships...
- Vehicles...
- Containers - above and below decks...
- Mixed cargoes...
- HAZMATs - IMDG Codes...
- Confined spaces...

Confined spaces...

- Air spaces...
- Double bottoms [DB's]...
- Deep tanks...
- Cofferdams...
- Twin hulls.

Remember.....Confined Space Regulations 1998

Hazardous materials [HAZMAT's]

- Containers of HAZMATs should be upper deck cargo, clearly identified on ships manifest...
- Norfolk 1991, two containers of 'Lindane' on beach!!..
- All ships have some form of HAZMAT e.g. fridge gases, tank fumes etc..

Tankers...

- **Crude** - Larger tanks, less pipework, [from field to refinery]...
- **Product** - Smaller tanks, more pipework etc., various products [refinery to end user]...
- **OBO** - Ore / Bulk / Oil...
- **Gas** - Methane, butane, etc....

Tanker tonnage...

- **LCC** - Large Crude Carrier
100,000 to 200,000 tonnes dw...
- **VLCC** - Very Large Crude Carrier
200 to 400,000 tonnes dw...
- **ULCC** - Ultra Large Crude Carrier
400,000 plus, tonnes dw...
- **Dead-weight** tonnage..is the 'carrying' capacity of the vessel [her earning power]...
[**Gross** tonnage.. 'cargo' space .Dry cargo and passenger ships only]



Summary

- Ships and boats...
- Terminology...
- Types of craft...
- Fire separation...
- Topography...
- Cargoes...
- Confined spaces...

Why is a ship called 'She'?...

...because there is always a great deal of bustle around her.

There is usually a gang of men around her.

She has a 'beam' and 'stays' and it takes considerable paint to keep her in 'trim'.

It takes an experienced man to handle her correctly; and without a man at the helm she is uncontrollable!

She displays her 'topsides', hides her 'bottom' and, when entering port always heads for the buoys after crossing the 'bar'!!!

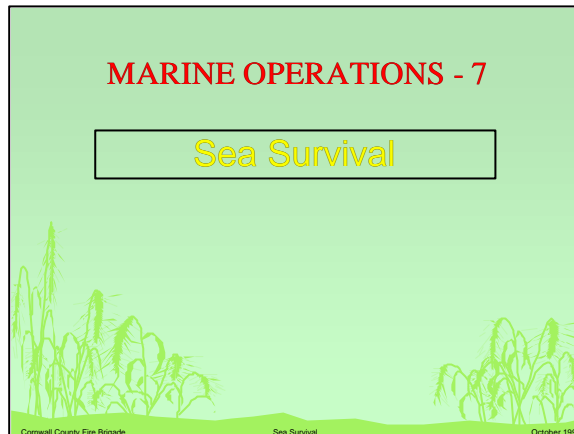

The 'Marine Operations' packages are produced by CCFB Marine Operations Group (MOG) and are as follows

Part 1...Safe Working On Or Near Water...

Part 2...Offshore Incidents ~The Legal Framework

Part 3...Offshore Incidents ~Command and Control

Part 4...Helicopter Operations ~ SOP

Part 5...Tactical Ship Firefighting

Part 6...Ship construction.

Part 7...Sea Survival

Part 8...Small Boat Fire Safety

Other reference points include:-

ICS.ppt

Fire Service Manuals ~ Command and Control / Marine Operations...

DCOL's...

BIS Doc's...

Case Studies e.g 'Scandinavian Star'

CACFOA South West ICS packages

This presentation forms the theory part of Cornwall County Fire Brigade's one day sea survival course.

This is followed by a practical session given by a qualified ,competent instructor.

Cornwall County Fire Brigade Sea Survival October 1997

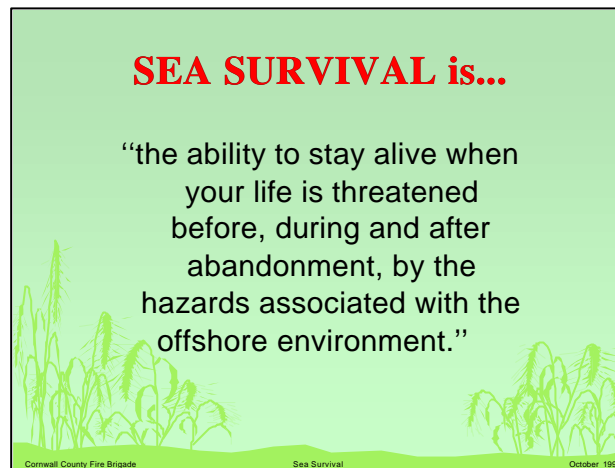

So what do we need to survive at sea?

S3...

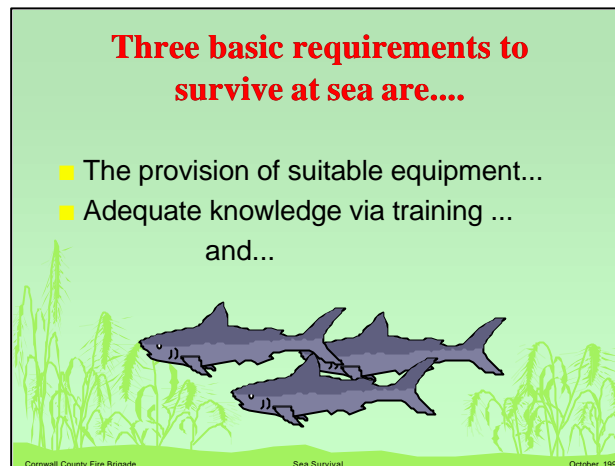

Equipment comes in the form of Lifejackets..[types].../ Immersion, transit suits/ Seabands.

Knowledge and training comes from attendance on this course and refresher training.

AND....next slide 4...



THE WILL TO SURVIVE...comes from the individual.

The equipment and knowledge will assist..but the WILL comes from within.

Piper Alpha examples from SST book/
Herald of Free Enterprise/ Estonia
disaster[Paul Barney].

Slide 5..Course aims....

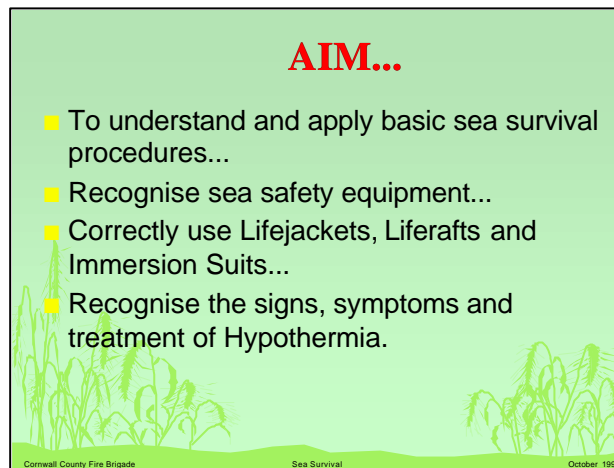

AIM...

- To understand and apply basic sea survival procedures...
- Recognise sea safety equipment...
- Correctly use Lifejackets, Liferrafts and Immersion Suits...
- Recognise the signs, symptoms and treatment of Hypothermia.

Cornwall County Fire Brigade Sea Survival October 1997

Explain the above by referring to the practical training being given and the information available to students in the pre course information folder.

Next slide..Objectives...

OBJECTIVE...

To give personnel employed onboard vessels, **alongside** or **offshore**, a basic working knowledge of life saving appliances, survival techniques and associated operational procedures.

Cornwall County Fire Brigade Sea Survival October 1997

Self explanatory, again as dictated by DCOL 9/92.

Next slide ..7...

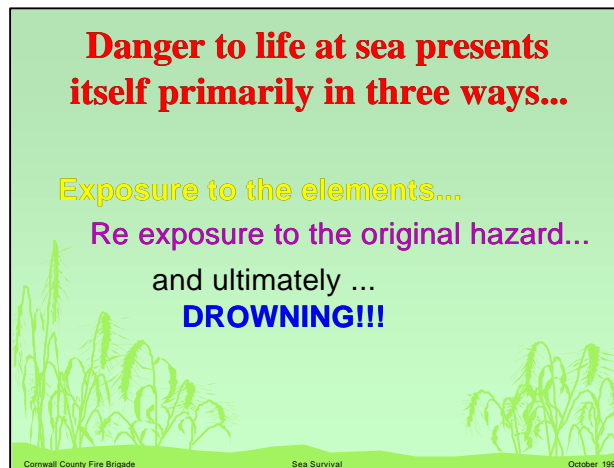

Primarily with regards hypothermia, mentioned later.

Going back to the hazard.

Drowning is a combination of carrying out incorrect actions once in the water, ie swimming [body heat] as seen in video.

Lets now look at equipment...

S8...Equipment ...Seabands



Explain and show Seabands. Info. in course file. Developed by Chinese doctor, based on acupuncture theory.

Used by health service[cancer care]./RFA's and other marine organisations.

Saves taking tablets particularly if about to work in heat/humidity.

Emphasise does not work for all.

S9...Equipment...lifeboats.

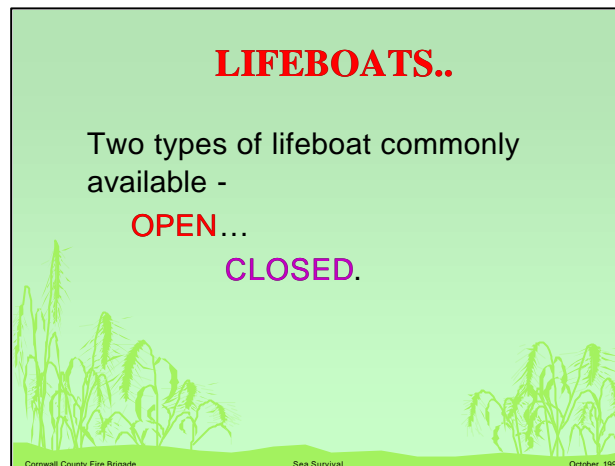

Two types of lifeboats...Open ie as on the Scandinavian Star[case history from Phase A] Titanic etc.

Closed...more modern. Found on all new ships and oil platforms. Provide greater protection form the elements and 'unsinkable'

S.10...Liferafts...

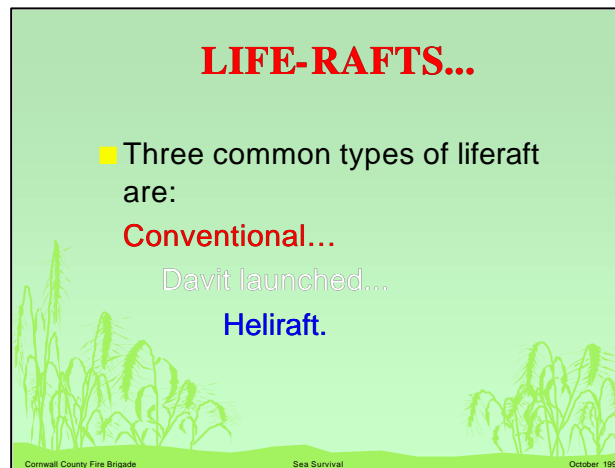

Three types of life-raft normally found. The Conventional is a ship's life-raft and found in containers around the vessel. The davit type is normally only found on fixed platforms, i.e. oil rigs and hangs inflated in a davit similar to a lifeboat.

The Heliraft comes in various sizes and are stored within the 'lining' of the helicopters.

S.11... Life-jackets...

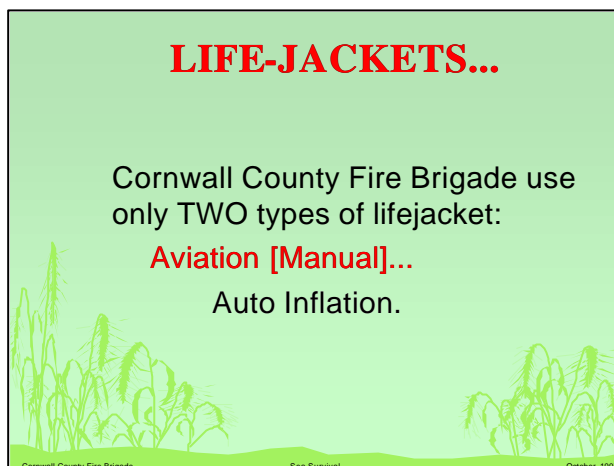

Three types of LJ:

PIB has some inbuilt buoy. and then requires additional air by mouth. [SHOW]

Aviation are non auto in operation due to being submerged and trapped. Manual operation, no inherent buoy. CO2 charge.

The Auto LJ is totally auto in operation ie water activated with manual back up, CO2 again. Both our Crewsaver and Falcon jackets are these with the ability to convert to aviation type. These will be demonstrated later.

S12...Regulations for LJ's...



Obviously a minefield.

The new Falcon Lj's are one of the few on the market to achieve a CEN standard, which is the highest.

S13...Lifejackets, requirements...

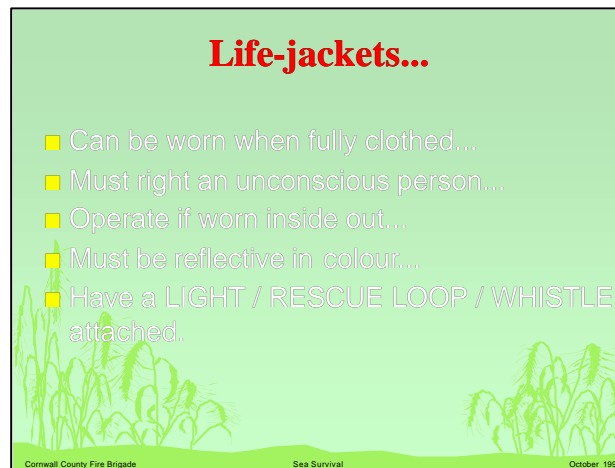

Explain the above. Emphasise that Crewsavers should be fitted with Snaplights but the new falcons are fitted with a water reactive light.

The rescue loop is NOT a lifting strop, purely for 'buddying' up.

S14...Note..wearing a LJ....

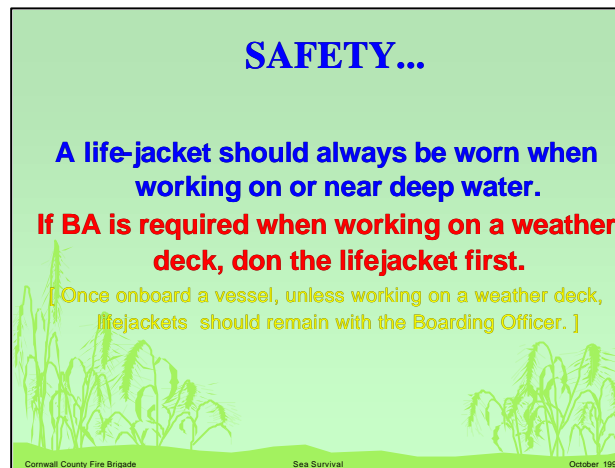

Self explanatory...

S.14...Immersion/transit suits...

Immersion/Transit Suits...

- Will be worn when flying; may be worn for seaborne transfer...

Check for correct size...

Wear appropriate undergarments...

Don correctly - teamwork...

Ventilate to prevent unwanted buoyancy...

Maintain integrity...

Don life-jacket...

If damaged - do not wear and tell somebody!!!

Cornwall County Fire Brigade Sea Survival October 1997

The suits will be demonstrated later. They are not Survival suits..purely for transit. They have no designed insulation/buoyancy. Make sure it fits and is not damaged. Wear firekit beneath for surface transit, Huggy Bear for helo. transit[because of air entrapment]. Don correctly, vent . Beware of air migration and water ingress. Lifejacket. Operational procedures.

Take care of them...and they will take care of you.

S.16...Entering the water...

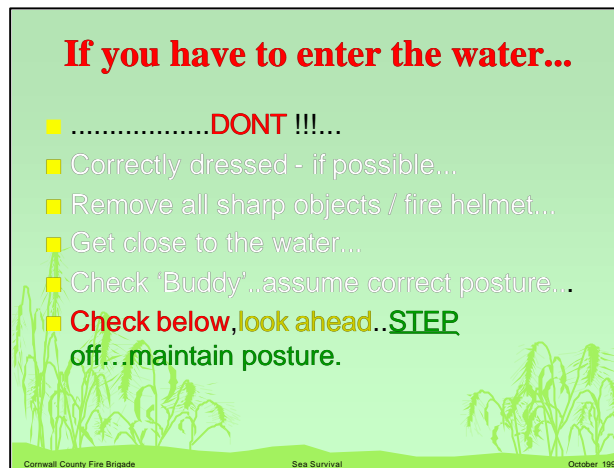

Self explanatory emphasise the DONT..ie increase chance of hypothermia and ultimately drowning.

Identify correct position for water entry.

Emphasise 'buddy' ie team work etc

S.17...Helo drill...

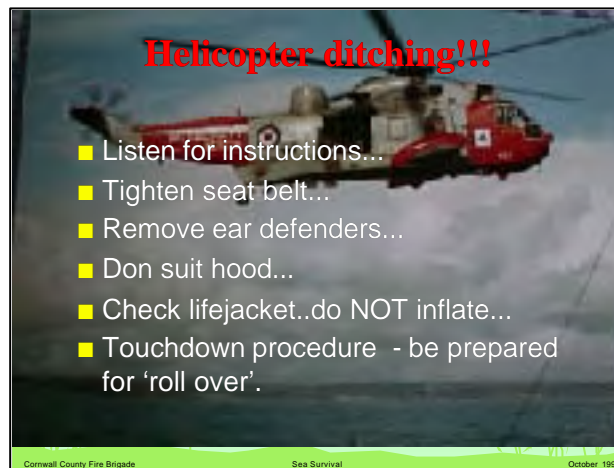

Emphasise all relevant points, particularly lifejackets and rollover.

Aide memoir...SHITE.

S.18 Next..so now you are in the water..

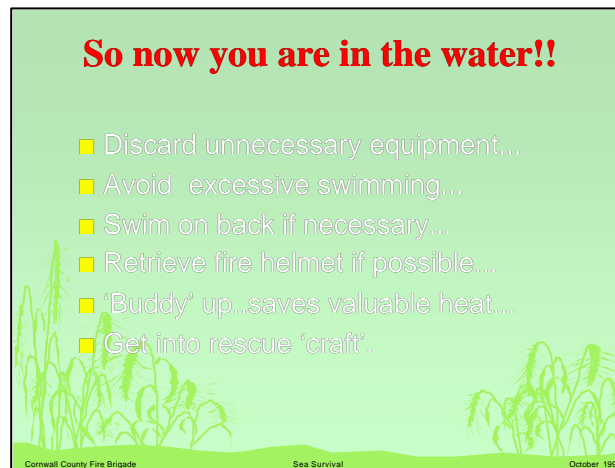

Self explain...

Avoid swimming...rapid loss of heat [seen in video].

Swimming on back more comfortable and less water taken in.

Fire helmet...keeps heat in/conspicuous

S.18...MOB procedure...

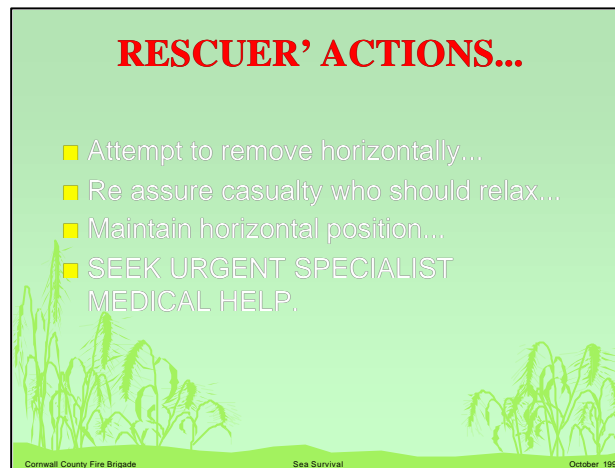

The casualty must not exert himself and the horizontal rescue position reduces the effects of the 'embolisms' moving around the body..

Supervision for 24 hours is of paramount importance. Secondary drowning can also occur within this time ie water remaining in the lungs.

S.21...Hypothermia...

**MAN OVERBOARD [MOB]
PROCEDURE...**

If a crew member enters the water: -

- Maintain visual contact and point at MOB...
- Raise verbal alarm...keep pointing...
- Launch a flotation marker i.e.... lifebuoy...
- Advise standby vessel / aircraft...
- When recovering MOB beware of IRCRC.....

Cornwall County Fire Brigade Sea Survival October 1997

Self explain....

Emphasise importance of keeping strict observation of mob’.

S.19... Immersion related circum rescue collapse....

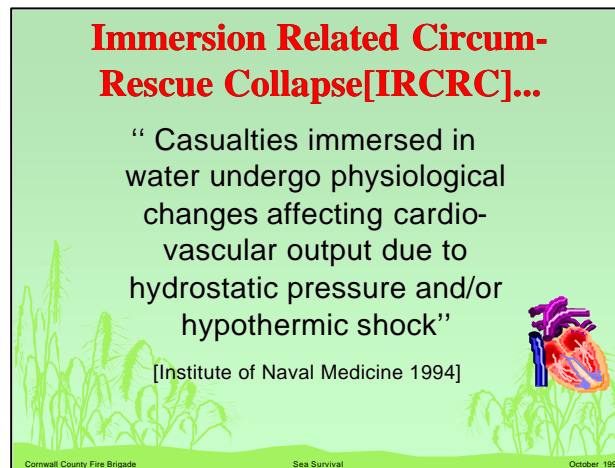

A form of embolism that is produced in the cardio vascular system after water immersion....this can kill if not identified and controlled/treated.

S.20...Rescuers actions to prevent IRCRC.....

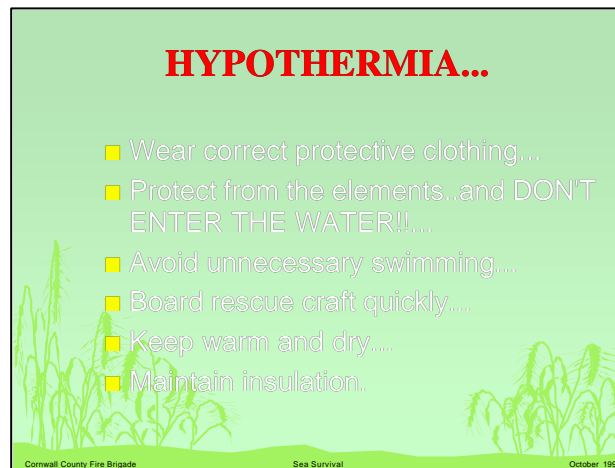

Self explain.... also in course folder.

Be aware that Hypo. can occur on the fireground at any time any place if the weather and physical conditions are correct.

S.22...Summary...

SUMMARY...

- Wear full PPE/Life-jacket...
- Know your vessel, and survival equipment...
- Consider Seasickness problems...
- Keep out of the water...
- Maintain 'Buddy' system...
- Be aware of Hypothermia, AND...

Cornwall County Fire Brigade Sea Survival October 1997

Self explain....

S.23...The Will to Survive...

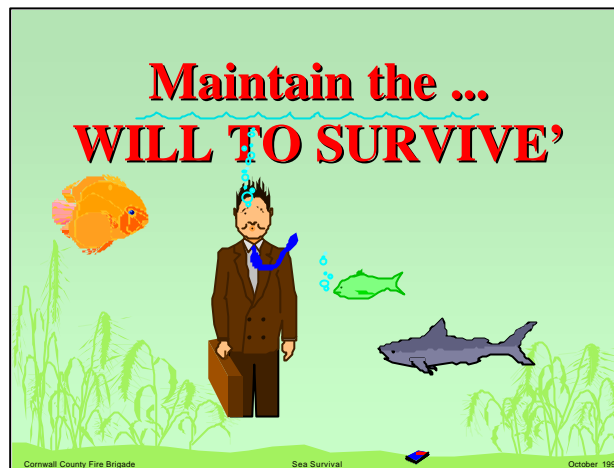

Re emphasise this....

Identify briefly how we will now go and practice some of the techniques and demonstrate the equipment.

Last slide

MARINE OPERATIONS - 7

Sea Survival

This presentation forms the theory part of Cornwall County Fire Brigade's one day sea survival course.

This is followed by a practical session given by a qualified ,competent instructor.

SEA SURVIVAL is...

“the ability to stay alive when your life is threatened before, during and after abandonment, by the hazards associated with the offshore environment.”

Three basic requirements to survive at sea are....

- The provision of suitable equipment...
 - Adequate knowledge via training ...
- and...

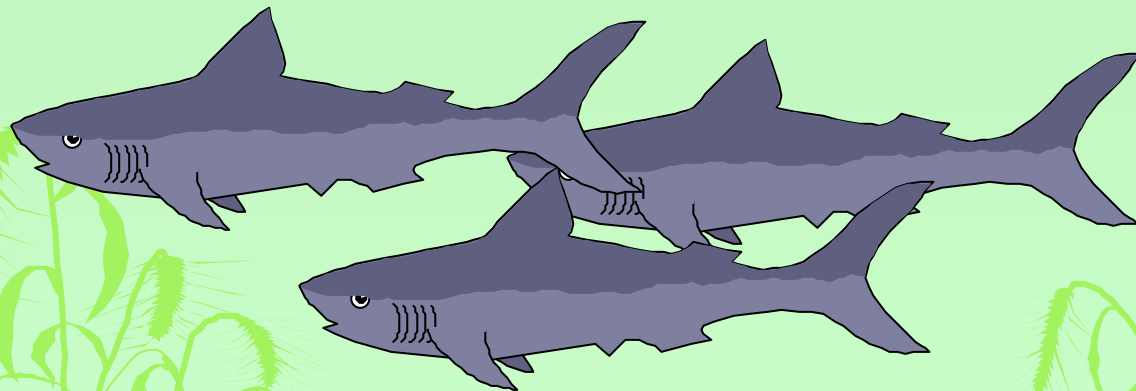

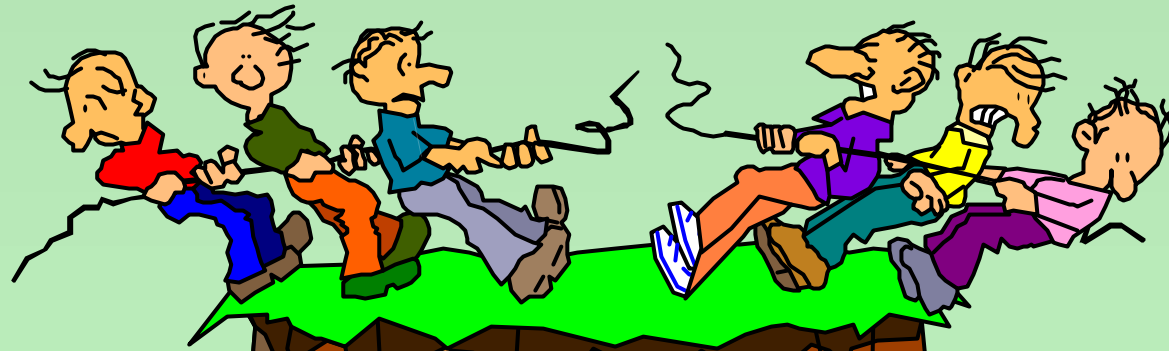

**THE WILL
TO
SURVIVE.....!!!**

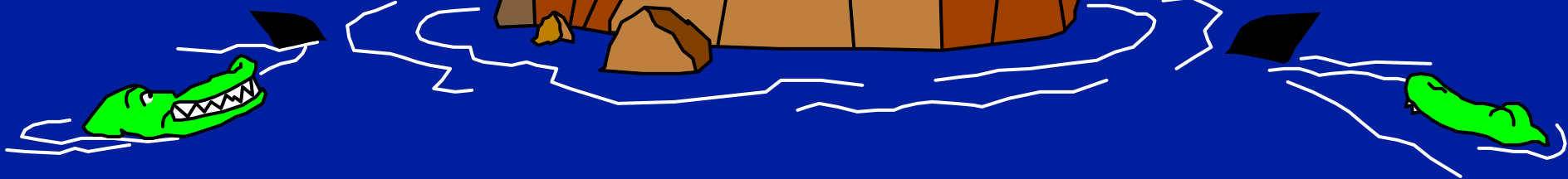

AIM...

- To understand and apply basic sea survival procedures...
- Recognise sea safety equipment...
- Correctly use Lifejackets, Liferrafts and Immersion Suits...
- Recognise the signs, symptoms and treatment of Hypothermia.

OBJECTIVE...

To give personnel employed onboard vessels, **alongside** or **offshore**, a basic working knowledge of life saving appliances, survival techniques and associated operational procedures.

Danger to life at sea presents itself primarily in three ways...

Exposure to the elements...

Re exposure to the original hazard...

and ultimately ...

DROWNING!!!

SEASICKNESS

- Use of anti-nausea 'Seabands...
- Worn at all times...
- NOT EFFECTIVE FOR ALL !!!...
- Tablets may cause side effects...
- Maintain liquid / food intake.

LIFEBOATS..

Two types of lifeboat commonly available -

OPEN...

CLOSED.

LIFE-RAFTS...

- Three common types of liferaft are:

Conventional...

Davit launched...

Heliraft.

LIFE-JACKETS...

Cornwall County Fire Brigade use only TWO types of lifejacket:

Aviation [Manual]...

Auto Inflation.

Lifejacket's regulations...

- British Standard...
- CEN ...
- SOLAS / IMO...
- Offshore Installation....
- Civil Aviation./ DoT.

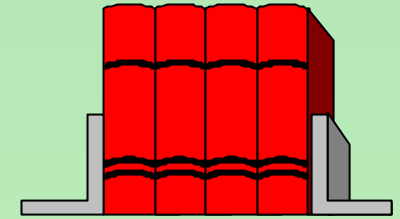

Life-jackets...

- Can be worn when fully clothed...
- Must right an unconscious person...
- Operate if worn inside out...
- Must be reflective in colour...
- Have a LIGHT / RESCUE LOOP / WHISTLE attached.

SAFETY...

A life-jacket should always be worn when working on or near deep water.

If BA is required when working on a weather deck, don the lifejacket first.

[Once onboard a vessel, unless working on a weather deck, lifejackets should remain with the Boarding Officer.]

Immersion/Transit Suits...

- Will be worn when flying; may be worn for seaborne transfer...

Check for correct size...

Wear appropriate undergarments...

Don correctly - teamwork...

Ventilate to prevent unwanted buoyancy...

Maintain integrity...

Don life-jacket...

If damaged - do not wear and tell somebody!!!

If you have to enter the water...

-**DONT** !!!...
- Correctly dressed - if possible...
- Remove all sharp objects / fire helmet...
- Get close to the water...
- Check 'Buddy' ..assume correct posture...
- **Check below, look ahead..STEP off...maintain posture.**

Helicopter ditching!!!

- Listen for instructions...
- Tighten seat belt...
- Remove ear defenders...
- Don suit hood...
- Check lifejacket..do NOT inflate...
- Touchdown procedure - be prepared for 'roll over'.

So now you are in the water!!

- Discard unnecessary equipment...
- Avoid excessive swimming...
- Swim on back if necessary...
- Retrieve fire helmet if possible...
- 'Buddy' up..saves valuable heat...
- Get into rescue 'craft'.

RESCUER' ACTIONS...

- Attempt to remove horizontally...
- Re assure casualty who should relax...
- Maintain horizontal position...
- **SEEK URGENT SPECIALIST MEDICAL HELP.**

MAN OVERBOARD [MOB] PROCEDURE...

If a crew member enters the water:-

- Maintain visual contact and point at MOB...
- Raise verbal alarm...keep pointing...
- Launch a flotation marker i.e.... lifebuoy...
- Advise standby vessel / aircraft...
- When recovering MOB beware of IRCRC.....

Immersion Related Circum- Rescue Collapse[IRCRC]...

“ Casualties immersed in water undergo physiological changes affecting cardiovascular output due to hydrostatic pressure and/or hypothermic shock”

[Institute of Naval Medicine 1994]

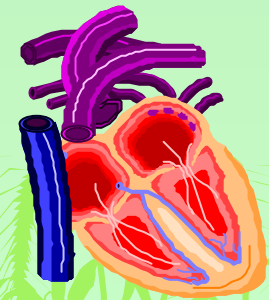

HYPOTHERMIA...

- Wear correct protective clothing...
- Protect from the elements..and DON'T ENTER THE WATER!!...
- Avoid unnecessary swimming...
- Board rescue craft quickly...
- Keep warm and dry...
- Maintain insulation.

SUMMARY...

- Wear full PPE/Life-jacket...
- Know your vessel, and survival equipment...
- Consider Seasickness problems...
- Keep out of the water...
- Maintain 'Buddy' system...
- Be aware of Hypothermia, AND...

Maintain the ... WILL TO SURVIVE'

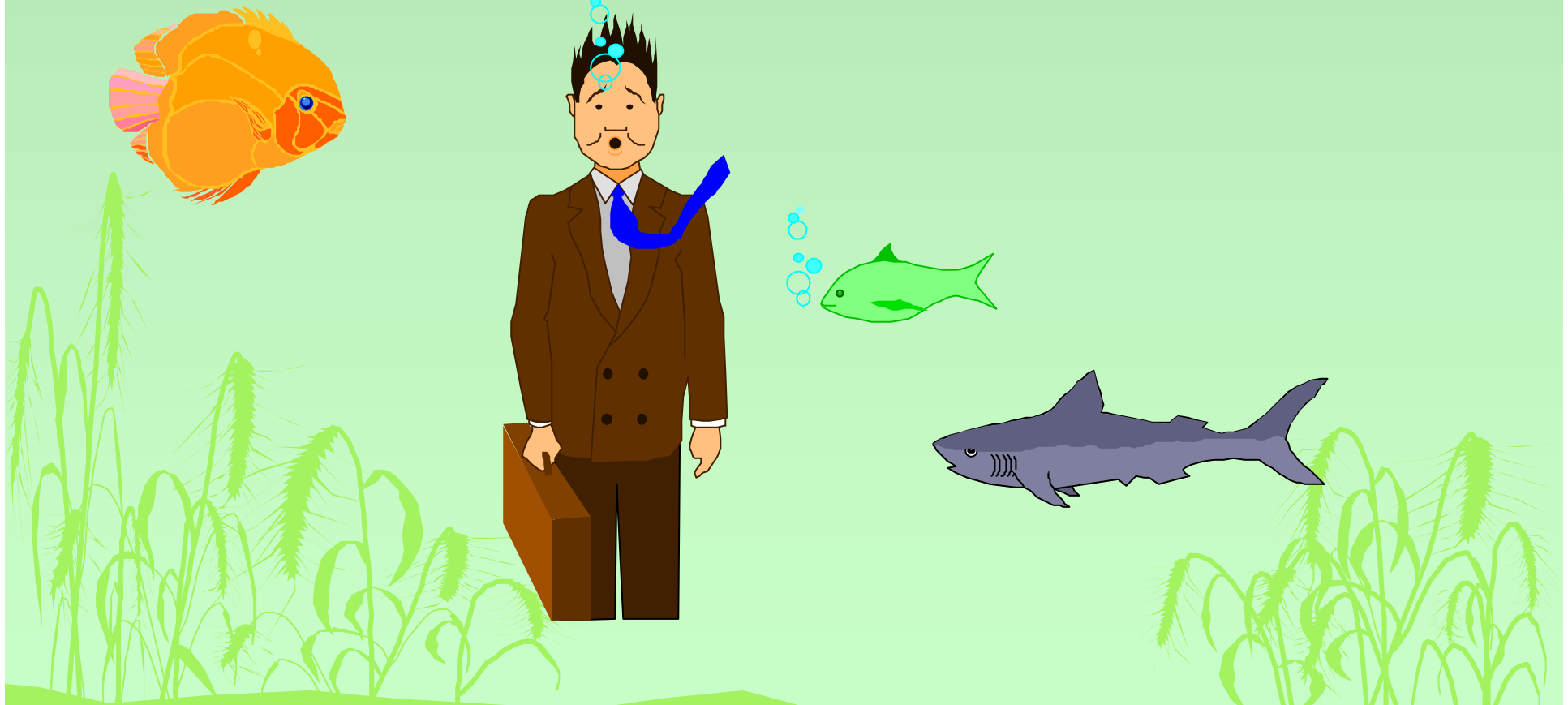



**Cornwall County Fire Brigade
Marine Operations - 8**

Small Boat Fire Safety

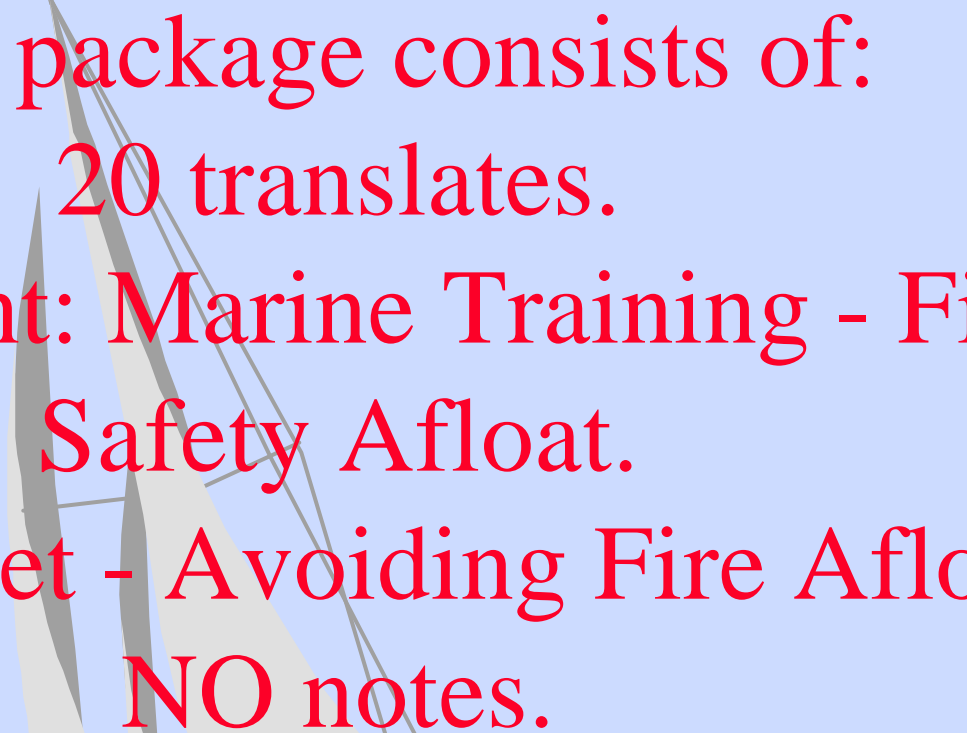

This package consists of:
20 translates.
Document: Marine Training - Fire
Safety Afloat.
FPA leaflet - Avoiding Fire Afloat.
NO notes.

MJK-Feb.97

Fires do occur in all sorts of craft!!!!



The Triangle of Combustion...

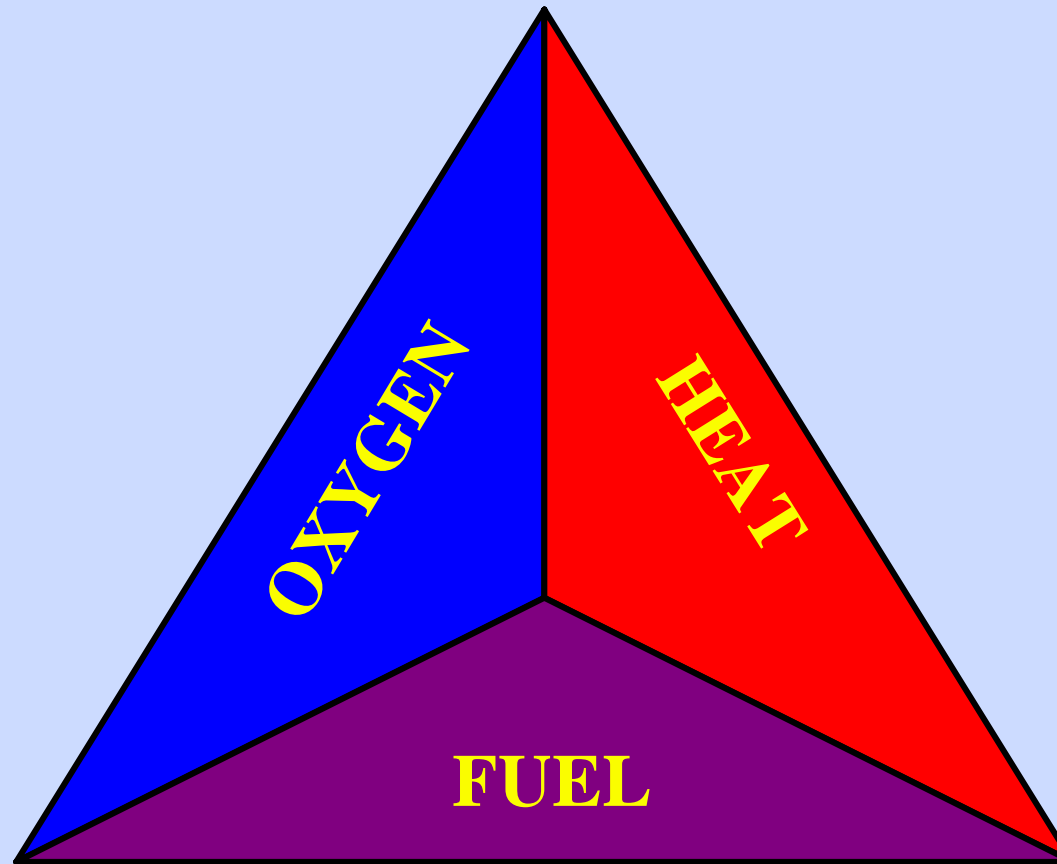

No combustion!!!

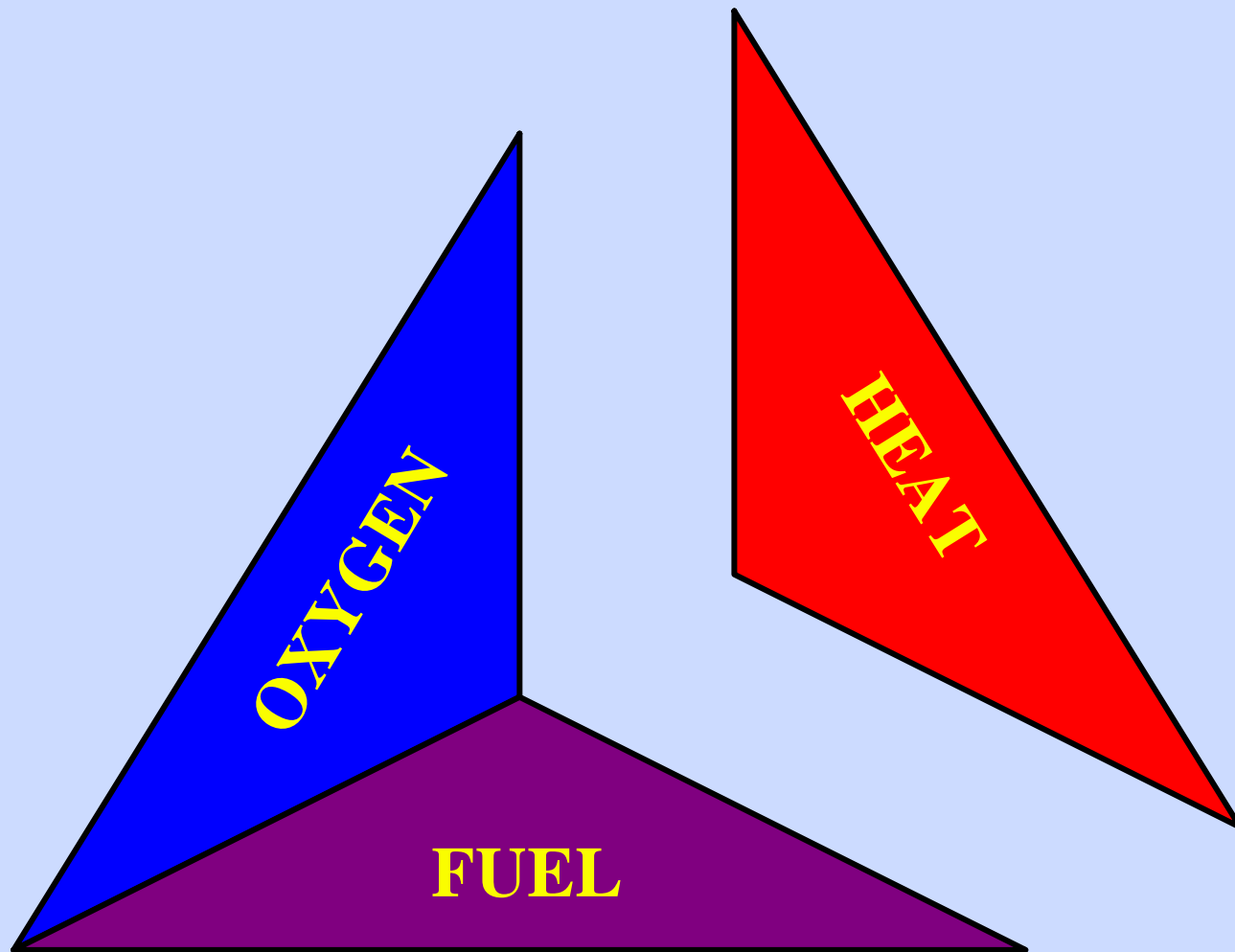



Classification of fires...

- CLASS A
 - CLASS B
 - CLASS C
 - CLASS D
 - Solids...
 - Liquids...
 - Gases ...
 - Metals.
- 

Types of extinguishers...

- Water...
- Foam...
- Dry powder...
- Carbon Dioxide...
- Halon...
- Fire blanket.

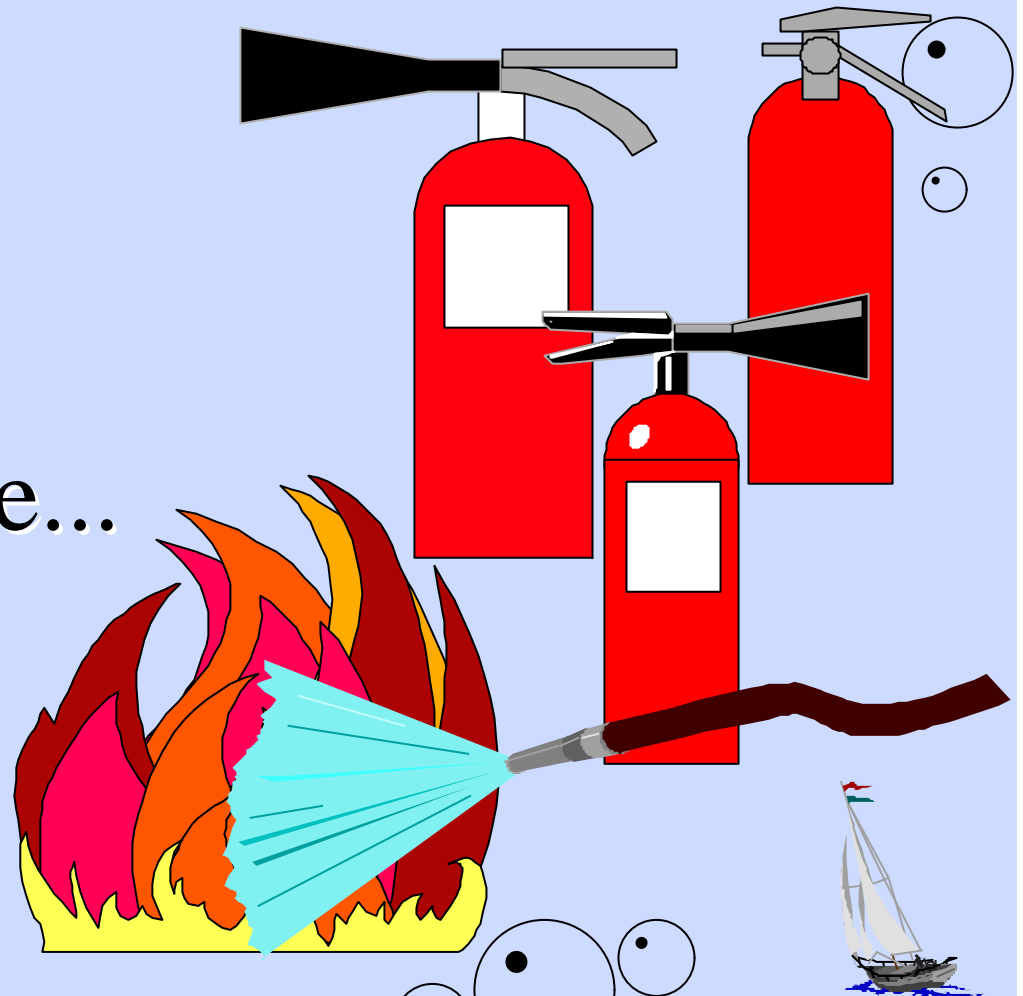

As you may see them...

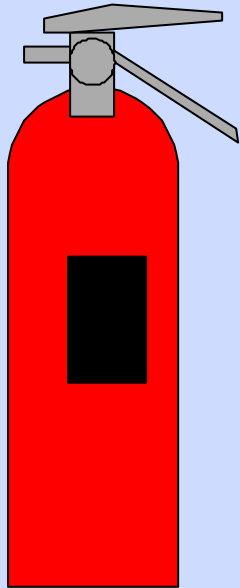

Water

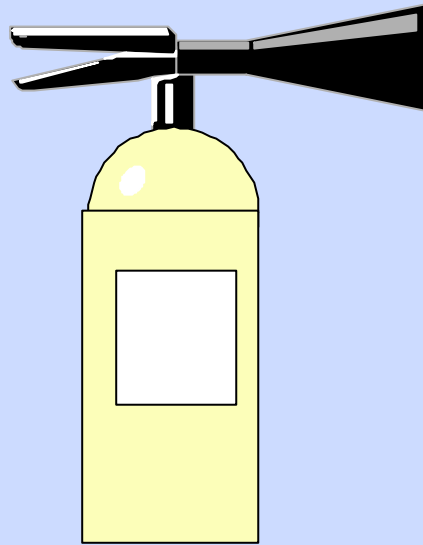

Foam

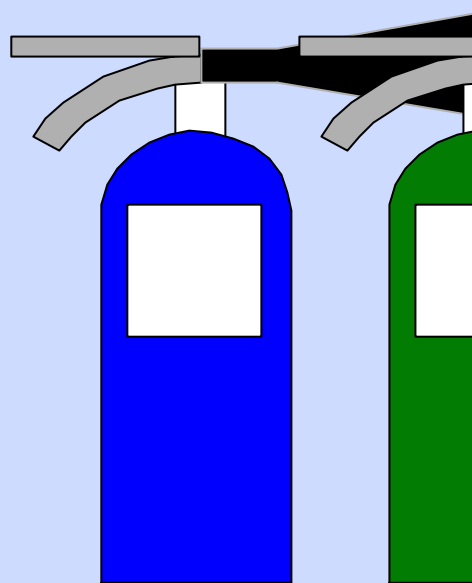

**Dry
Powder**

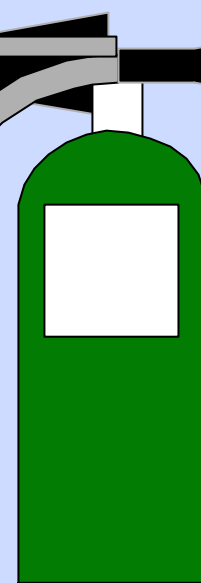

Halon

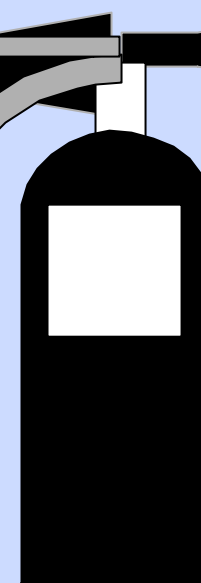

**Carbon
Dioxide**



Colour coding...

January 1997.

The European Standard specifies that all fire extinguishers will be **Red with a colour code block.**

[Not retrospective]

• The man from Brussels!



STORED PRESSURE.

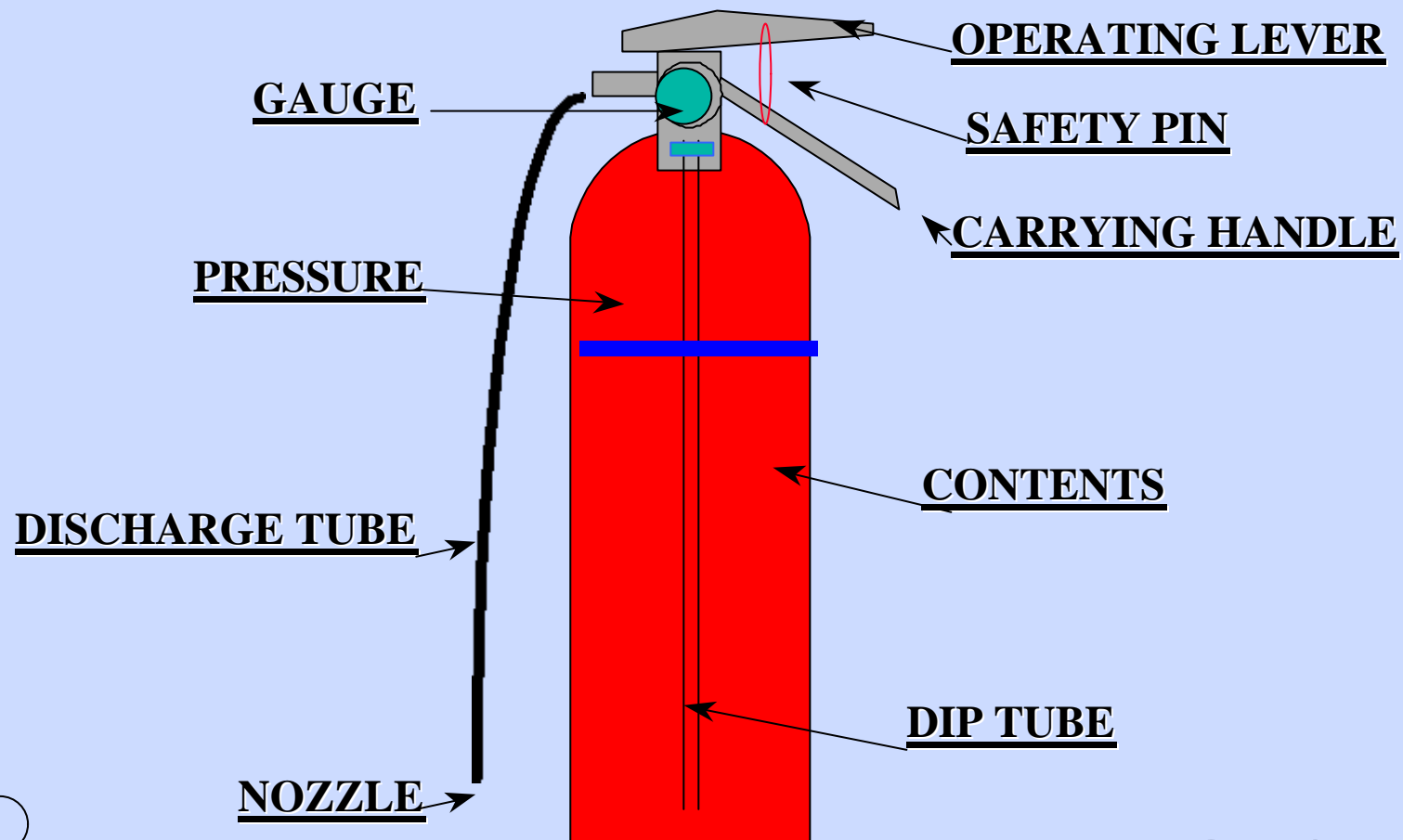

GAS CARTRIDGE.

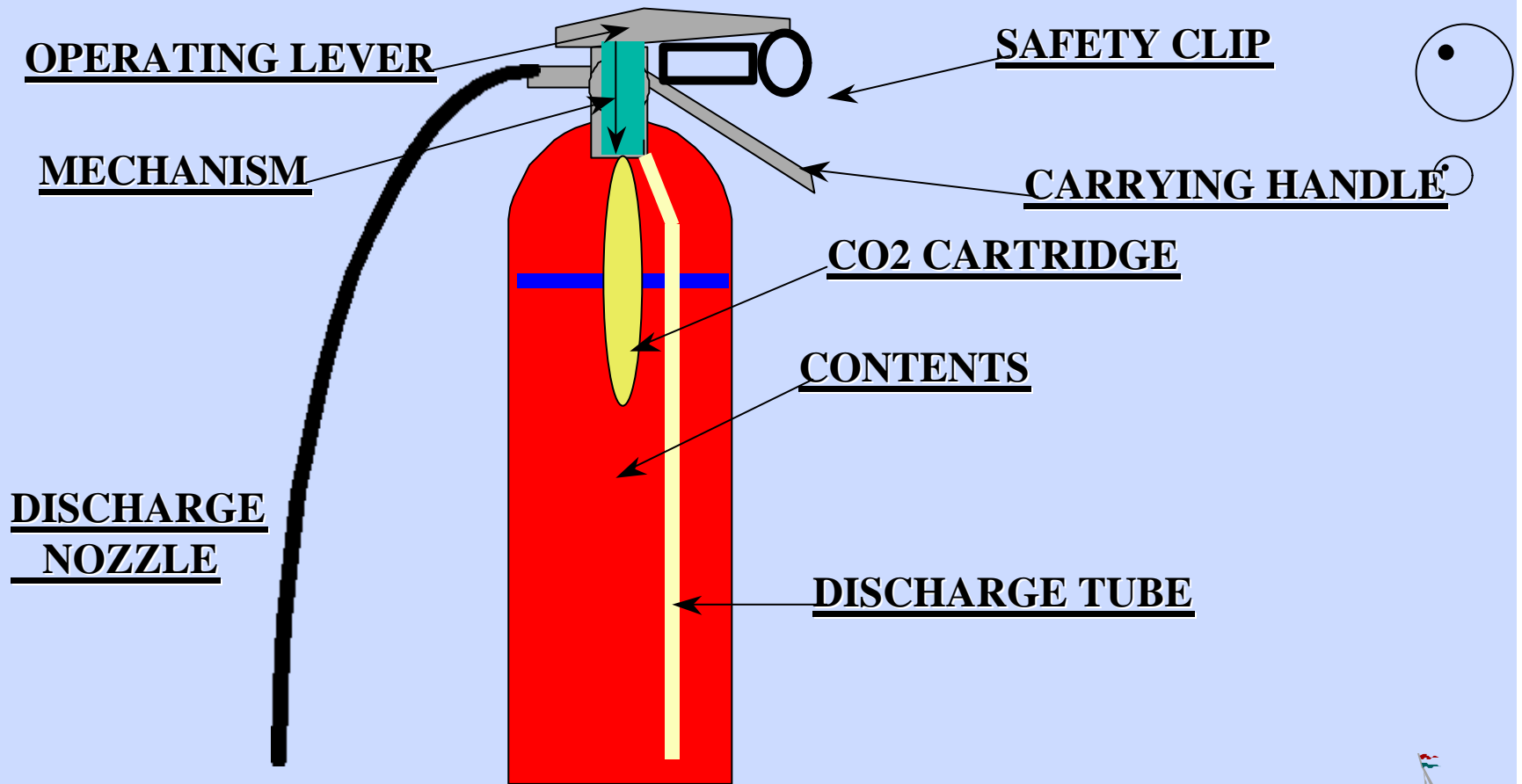



GENERAL SAFETY RULE..

Do NOT use water on class B
fires i.e... fuels.

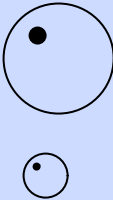

Water will instantly turn to
steam causing a rapid 'boil'
over!!!



BURNS...OUCH!!!

CARBON DIOXIDE [CO2].

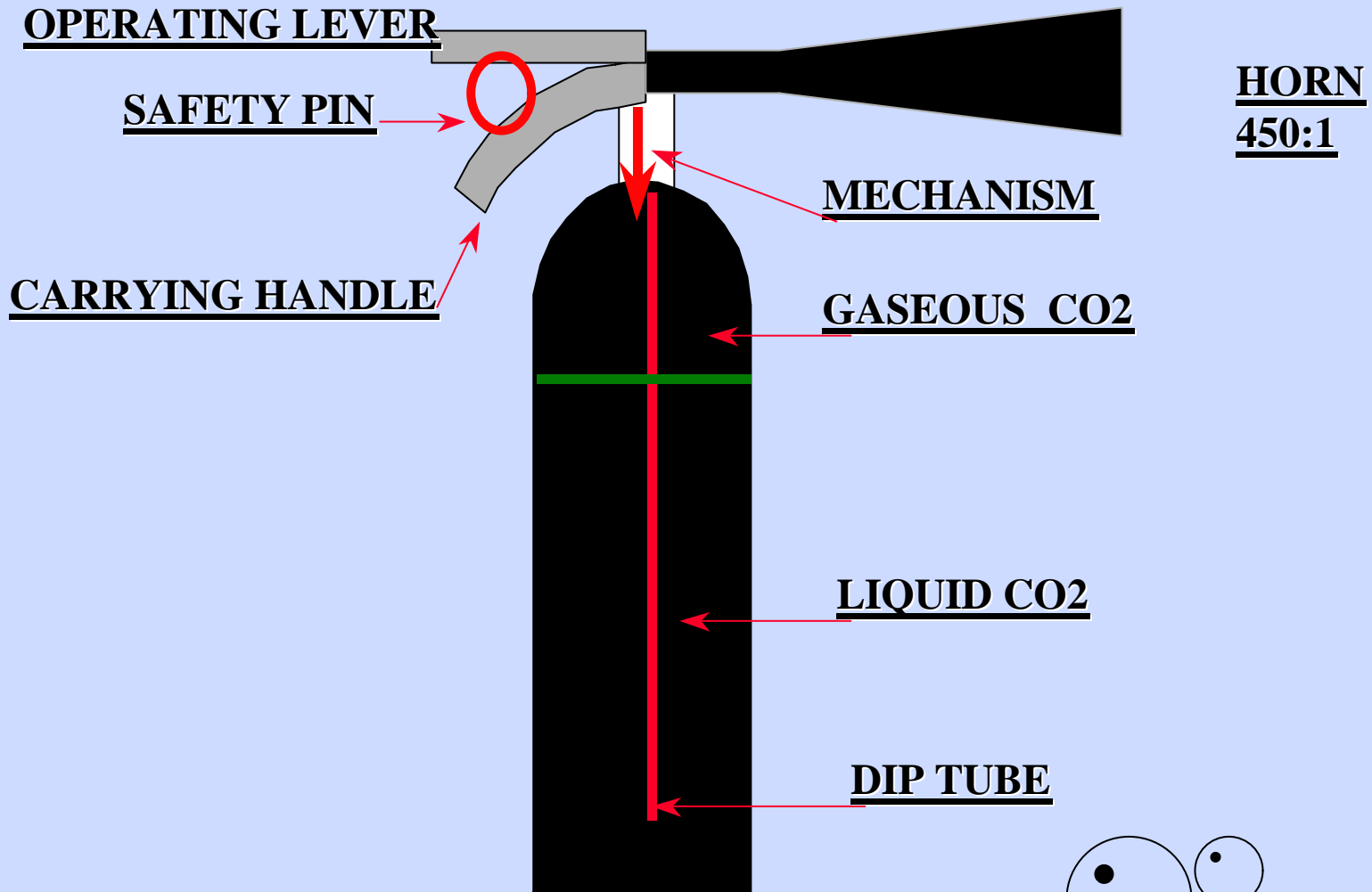



Fire Blankets...

*Should satisfy the specification
and test criteria prescribed in
British Standard 6575: 1985 -
British Standard
Specification for Fire
Blankets*

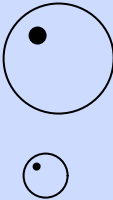

General 'boatkeeping'...

- **DO** - fit a smoke detector...
- **DO** - ensure furnishings[foam] and insulation is fire retardant...
- **DO** - run wiring looms through conduit to avoid chafing...
- **DO** - contain and vent battery boxes...
- **DO NOT** keep waste oily rags...
- **DO NOT** store non safety matches .. vibration!



Petrol...

- **DO** use approved containers and store on deck...
- **DO** - use a funnel when decanting...
- **DO** ensure tanks vent directly overboard and fuel lines have a **shut off valve** THAT WORKS!!...
- **STOP** the engine when refuelling **NO SMOKING or NAKED LIGHTS...**
- Clear any spillage and ventilate.





Liquified Petroleum Gas (LPG)...

- **DO** - fit a gas detection system...
- **DO** - secure cylinders securely in a sealed container with atmospheric vent...
- **USE** - approved piping ...
- **DO** - isolate cylinders when not in use...
- **DO** - maintain adequate ventilation...
- **DO** - regularly 'hand pump' bilge.

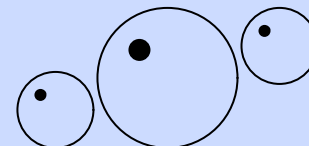
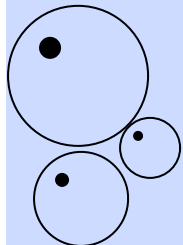



Diesel / Paraffin...

Although normal vapour concentrations are outside low flash point limits, they can fuel a developing fire...treat with similar respect!!!

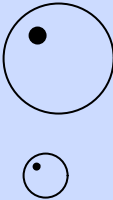

Methods of extinguishing fire afloat...



Think ...

**When do you
use a fire
extinguisher
???**

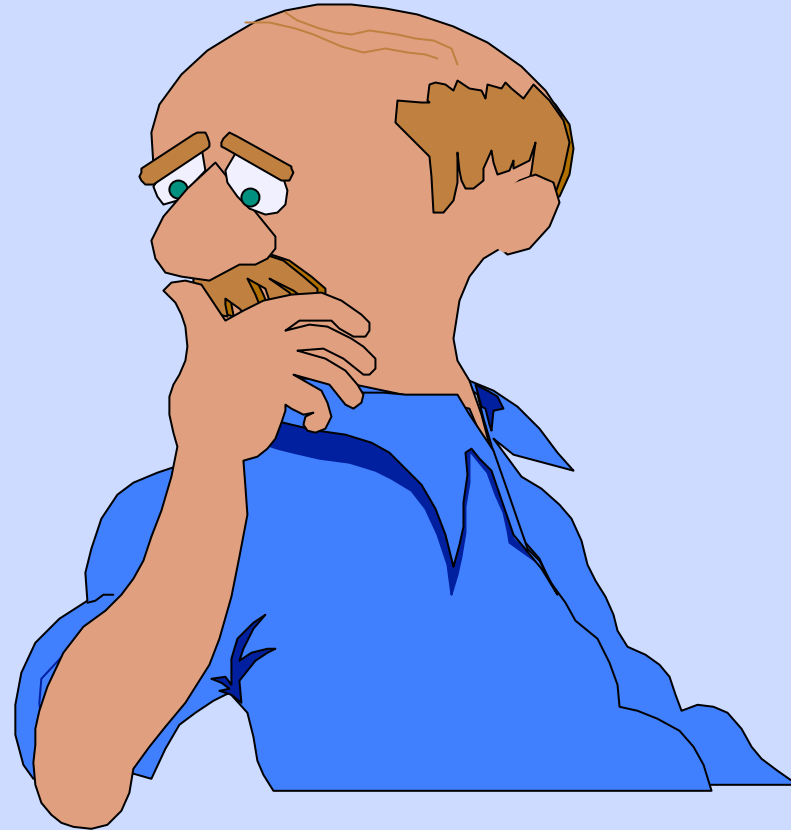



IF IT IS SAFE TO DO SO WITHOUT
PUTTING YOURSELF IN
DANGER!!!



....difficult on a small boat!!!

- **When there is a fire!!!...**
 - **If you have been trained...**
 - **Have the right equipment.**
- 

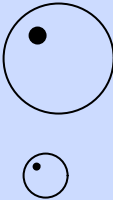

How???

- Have extinguishers located near the exits...
 - Ensure you know how they operate...
 - Isolate gas and petrol if possible..
 - Realise your limitations...
 - Keep low...
 - Aim at the base of the fire (not foam)...
- 

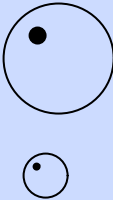

and...

- Avoid other craft..and alert them...
 - Prepare emergency ‘grab’ bag and liferaft...
 - Remove non essential crew...
 - If all else fails...
 - **ABANDON SHIP!!!**
- 



Remember - SAFETY...

Fires involving 'oils' and electrical apparatus and systems...

Do **NOT** use water...although there is lots of it!!

Isolate supply..if safe to do so!!!





and...

ensure you service your fire
extinguishers / detectors etc
annually, preferably prior to
the start of the season...

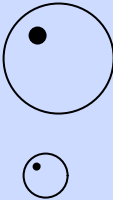

**you may need them one
day!!!**



Thankyou!!!

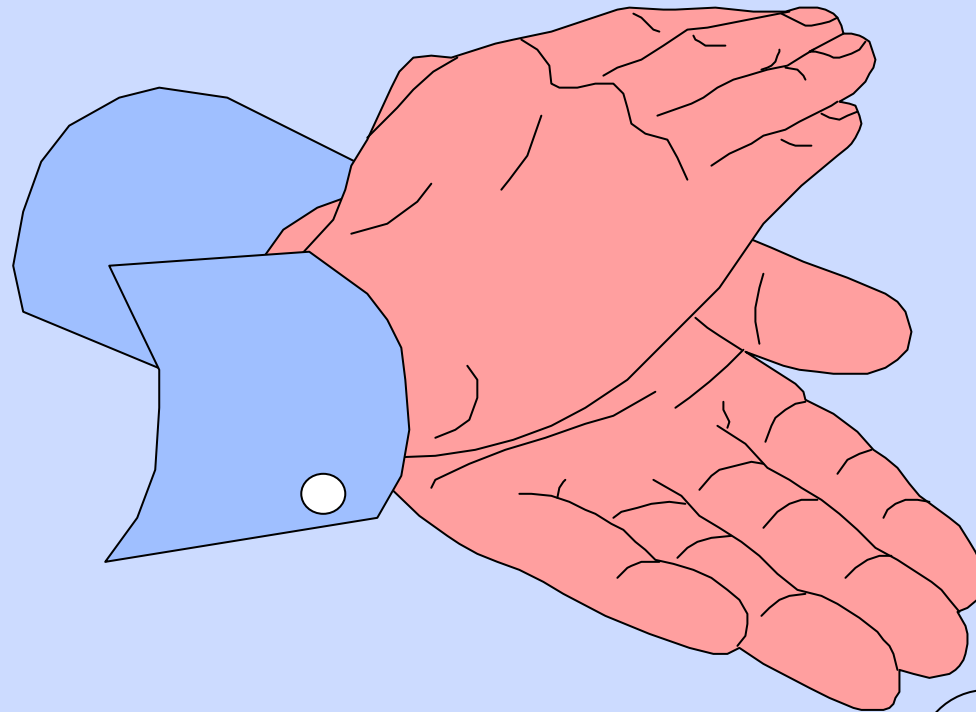

MARINE OPERATIONS ~ 'Safe Working On Or Near Water'

Summary:-

Information on pre-planning and operational considerations for water related incidents including , ice, mud, sand and unstable ground. Environmental incidents resulting from escape of 'slurry'.

Further Information:-

Marine Operations Group ~ Training Packages
BIS docs.- Marine Operations~ Ship Firefighting
~ Helicopter Operations

DCOL 3/2000 Item E

Contents		Page
INDEX:-		1
KEY INFORMATION:- ~ Water Related Incidents (WRI's)		2
PRIMARY INFORMATION:-		3
1. INTRODUCTION		4
2. COMMAND AND CONTROL		
3. STANDARD OPERATIONAL PROCEDURES		4 - 11
4. SUB SURFACE RESCUES/RECOVERY		11
5. ICE RESCUES		12
6. MUD, SAND/CLAY RESCUES		13
7. ANIMAL RESCUES		14
8. VEHICLES IN WATER		14-15
9. POST INCIDENT CARE		16-17
SUPPORTING INFORMATION:-		
10. WATER HAZARDS		
11. BIOLOGICAL CONTAMINATION		18-19
12. HELICOPTER OPERATIONS		20
13. GLOSSARY		21-22 23-24

WATER RELATED INCIDENTS (WRI's)

KEY INFORMATION

HAZARDS

E.g ~ Drowning. / Hypothermia. / Bacterial Contamination / Unknown Ice thickness.
~ Tides, Currents, Depths and Underwater Obstructions

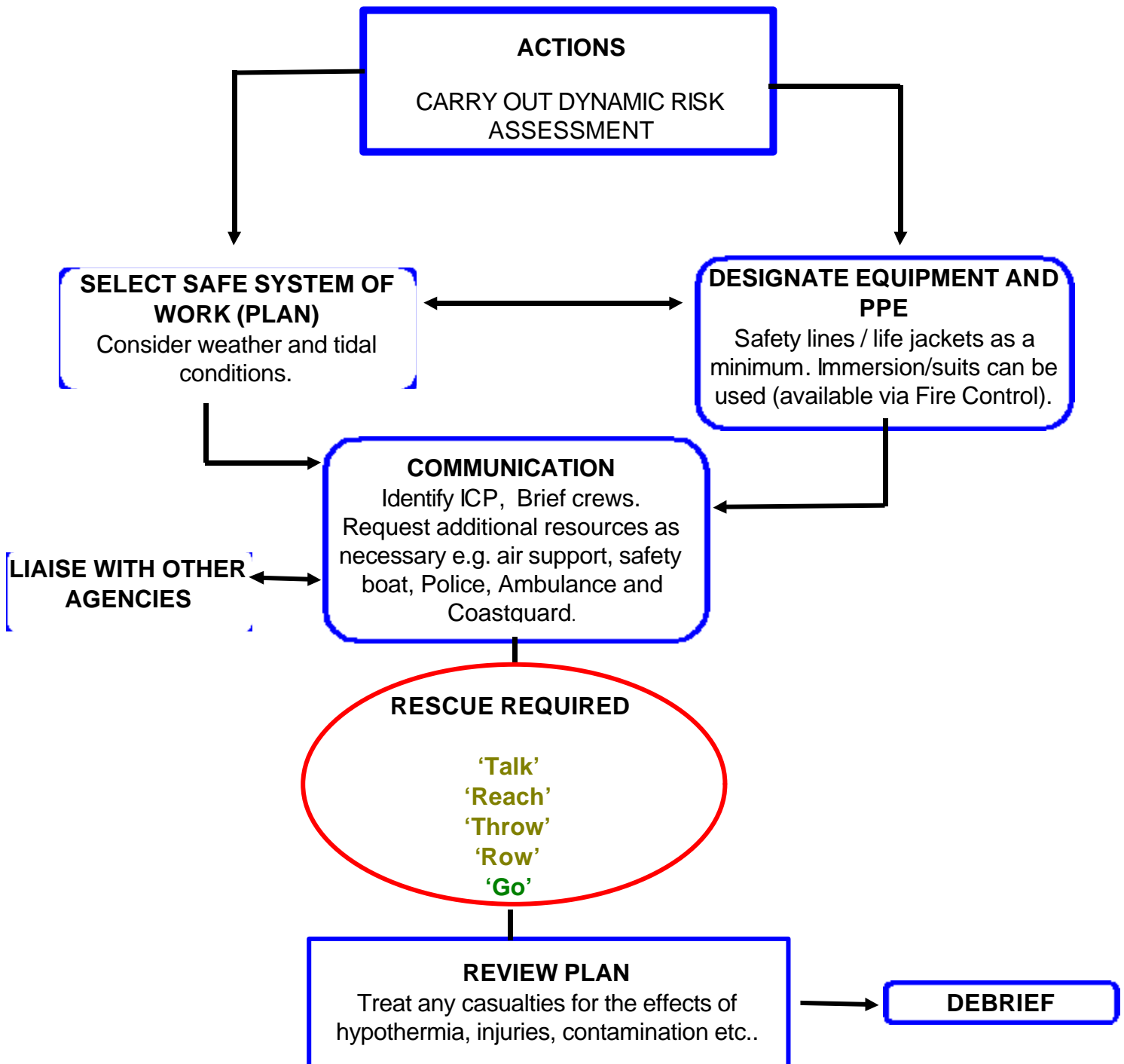

PRIMARY INFORMATION

1. INTRODUCTION

The Brigade attends a number water related incidents (WRI's) each year where personnel are potentially at risk from injury or loss of life due to working in close proximity to water. Personnel must be aware of the dangers presented at such incidents and ensure that the safety of all concerned in these activities is maintained through pre-planning and/or operational dynamic risk assessment.

The Brigade does not have a statutory duty to respond and apply resources to incidents of this type, where fire is not involved. However, no other emergency service is prepared to provide the level of response expected by the public on inland waterways and the Brigade is perceived as the prime rescue service across a wide diversity of hazardous situations.

The Brigade recognises and accepts this moral responsibility and will provide an appropriate level of response to all distress calls it receives.

Although the primary water risk within the county stems from coastal and estuarial waters, a number of other risk areas exist such as:-

- Offshore.
- Fast and/or deep running rivers.
- Reservoirs.
- Ponds and lakes.
- Quarries.
- Mine shafts.
- Local flooding.
- Slurry pits.

These risk areas in turn can be sub-divided into categories of tasks and for each subjects the firefighter to some degree of hazard. Although these are numerous they mainly fall under the following headings:-

- Working alongside water.
- Working on/being transported on water.
- Pumping from open water.
- Water rescues including submerged vehicles.
- Mud/sand rescues.
- Ice rescues.

Other areas of activity, such as sewer and slurry pit rescues, will also subject firefighters to similar hazards, but due to the nature of such risks additional safeguards will be required to protect the individual from contamination, infection or asphyxiation. These additional risks are dealt with separately and details can be found in the Brigade Information System and the Fire Service Manuals (FSM's).

2. COMMAND AND CONTROL

The Brigade will rely on Incident Commanders (IC's) applying the generic procedures encompassed within this document, the Incident Command System utilising the principles of dynamic risk assessment and the safe person concept.

Additionally, current, relevant and high quality information will be communicated to all operational personnel to provide them with the information enabling them to assess risks as objectively as practicable.

Each situation involving the above activities will present its own difficulties and problems, therefore this policy cannot be prescriptive. However, its contents should be viewed as the absolute minimum and IC's will determine the course of action according to the individual circumstances of the situation. *Nevertheless, the following items must be used as a framework of minimum safety.*

- In all instances the safety and welfare of Brigade personnel is of paramount importance.
- IC's must ensure that all elements of Command and Control are followed.
- A risk assessment is to be undertaken prior to setting priorities and allocating tasks.
- Where the rescue of animals is involved, undue risk to human life should not be taken.
- Risk must be proportional to benefit at all times.

3. STANDARD OPERATIONAL PROCEDURES (SOP)

Attendance:

The emergency response provided by the Brigade to water related incidents (WRI's) is essentially modular and can be illustrated as two progressive levels.

Level 1 All WRI's that require an initial attendance of either a Supervisory Officer and/or crew with knowledge, basic training, limited PPE, safe working practices and procedures covered in this document.

Level 2 Persons Reported - Level 1 supported by attendance of crews with enhanced training and equipment.

Water rescues may require a larger attendance than other Emergency Special Service Calls (SSC's), to provide both resources for the rescue and to provide a greater degree of safety to personnel.

NB. IC's should consider the involvement of other services such as:

- The Coastguard
- RNLi
- Police Underwater Search Unit
- Ambulance/Paramedics
- Royal Society for the Prevention of Cruelty to Animals (RSPCA)
- Environment Agency (EA)
- Emergency Planning Departments

However, it should be advised that an anticipated early emergency response may not be forthcoming and the relevant mobilising centre needs to advise the IC as a matter of urgency of any delays anticipated.

Drivers of all Brigade vehicles must continually assess their ability to proceed to incidents taking into account local environmental conditions.

Vehicles should park at a 'safe' area and allow crews to dress in the appropriate PPE e.g immersion suits etc before committing to any 'offensive' tactics.

Safety of Personnel:

This is paramount and IC's must ensure that:

- They do not enter the water unless absolutely necessary.
- Lifejackets and/or suitable buoyancy aids are worn by all firefighters working on or near the water, i.e., the "Risk Zone" (which, extends 3 metre horizontally from the water).
- Use appropriate PPE whenever possible to prevent cold shock, hypothermia, and contamination (even in summer water temperature can debilitate rescuers within a relatively short time).
- A Safety Officer is appointed as soon as practicably possible.
- The IC gives consideration to any personnel in or near the water using a safety line.
- All non-essential personnel must stay out of the risk area.
- Panic of a Casualty: - A drowning person when physically contacted by an in-water rescuer may attempt to climb on top of the rescuer; overcoming the rescuers buoyancy and submerging them both.
- Physical contact with a struggling casualty should be avoided whenever possible. Offer a buoyancy aid, line, etc. Tow casualty to safety.

Fire fighting PPE affords mechanical and limited thermal protection and is slightly positively buoyant in water (mainly due to the air both inside the fabric/material and air pockets trapped between the material and wearer). Water entering fire boots will equalise and will not have a detrimental sinking effect.

Initial Actions on Arrival

The Dynamic Risk Assessment (DRA) process must be carried out.

The IC at a WRI may be faced with many difficult decisions and the greatest difficulty may be in stopping ill conceived and reckless rescue attempts being made (where a rescuer may become a victim).

Firm control must be exercised to ensure that unauthorised personnel do not venture into the water.

Any witnesses should be interviewed to ascertain what has happened, how many people are involved, where any casualty was last seen, etc.

Then a logical plan of action, taking into account all possible hazards, must be devised and initiated as quickly as possible, with the safety of personnel as the overriding factor.

NB.

'When a person has disappeared below the surface of the water little can be achieved without specialist equipment or personnel. A clear distinction must be drawn as to when a rescue attempt becomes a body recovery'.

Key tactical considerations ~ water rescue.

This procedure is dependent on applying a prioritised approach to water rescues, Talk, Reach, Throw, Row are the preferred options, with entry to water as a very last resort.

Any attempt to rescue people or animals from waterways or associated hazards without the aid of specialist PPE and ancillary equipment should be carried out from the safety of firm ground (bank) or a structure (bridge or jetty).

Also:

- Only the minimum number of personnel should be used to undertake the task.
- Weather conditions and the duration of the incident may increase the requirement to rotate crews.
- At night, lighting of the scene is a priority.
- Always deploy upstream spotters above the location of the rescue operations, ideally on both sides of the river.
- Consider alternative measures to cater for a sudden change of situation i.e. prepare a secondary plan of action.

Talk It is important that contact is made with the casualty as quickly as possible. Keep talking to them, explain what you are going to do, what you want them to do and keep encouraging them.

Reach Either with your hand, or equipment from the appliance - e.g. ceiling hook, chimney rods, inflated fire hose then pull the casualty to firm ground. By lying down, you can increase the distance reached and also prevent yourself being pulled in.

Throw Use a purpose designed Throw Line and/or BA Guide Line. Throw one end out to the casualty. Do not weight the bag or the thrown end as it may injure the casualty.

Row If a boat is available then care must be taken to ensure that it does not capsize during the rescue. If it is powered, approach the casualty bow on and as soon as the contact is made switch off if safe to do so. It may then be better to row the boat to shore towing the casualty rather than try to pull the casualty aboard.

Remember never to stand up in a small boat and be aware of underwater obstructions particularly if using an inflatable boat.

Go ***Only if all these fail, as a very last resort should suitably trained personnel enter the water to attempt to facilitate a rescue.***

Where the Incident Commander is faced with a rescue situation (after considering all other courses of action) it is determined that the only possible approach is to commit personnel to the water to carry out a swimming rescue, the following control measures must be in place.

For 'still' water rescues:

- A Line Safety Officer should be appointed to control each rescue swimmers floating line.
- All personnel must be fully briefed regarding the rescue procedure and the role of each individual.
- Effective communications must be established between the IC the rescue swimmer and all safety personnel.

For 'fast flowing' water rescues:

- The risks associated specifically with swimming rescues from flowing water are extremely high. Only personnel who have received enhanced training and are provided with the appropriate PPE should attempt to perform this type of rescue.
- If personnel wade in rivers they should take care not to trap their feet in rocks or other debris, which may cause them to lose their balance, fall and be prevented from standing due to the force of the water flowing over them.
As a general rule, never wade in water, which is above knee high.
- Anyone *entering* the water should be dressed in the appropriate PPE
- Firefighters provided with a life jacket and suitable communications should be deployed as spotters upstream to warn of any surface debris heading towards the rescue scene. The spotters must maintain regular communication with the IC. Their position should be such as to allow adequate time for rescuers to get clear of the rescue scene before the hazard arrives.
- Downstream, a boom of inflated fire hose (or similar), the boat, or personnel with throwing lines, should be positioned as a safety measure for any rescuer who may accidentally enter the water and be carried along with the flow. (When using throwing lines, the number of safety personnel should reflect the number of casualties and rescuers in the danger area, but in any case must be a minimum of two).

In situations where it has been determined that a swimming rescue will be attempted, buoyancy aids such as inflated fire hose or composite BA cylinder, etc., must be used to attempt to stabilise the casualty.

A floating line and harness must be attached to the rescue swimmer.

Raising a hand directly above the head is a recognised method for a rescue swimmer to indicate they are in difficulty and/or need removing from the water. All personnel must understand this signal and the action to take should it be given.

Entry into the water must be done slowly to minimise cold-water shock and reduce the chance of injury. The person entering the water should have a means of gauging the depth, e.g. ceiling hook.

N.B. RAPID IMMERSION IN COLD WATER CAN COMPROMISE GOOD SWIMMERS ALMOST IMMEDIATELY.

In the event of Brigade personnel accidentally falling into water and finding themselves in difficulty a standard message must be formulated and transmitted to provide immediate assistance at the incident.

Similar to the BA and incident ground emergencies the message can be sent by anyone from the incident by contacting Brigade Control and stating "Water Emergency". On receipt of the message Brigade Control will mobilise the following:

- I. Level 2 attendance.
- II. Search & Rescue (SAR) Helicopter.
- III. Duty Officer.
- IV. Ambulance.
- V. Accident Investigation Officer.

This new procedure is designed to be in line with existing messages and procedures. It provides a short, simple method of obtaining urgent assistance when firefighters are in difficulty.

Use of Safety Lines

Approved safety lines and harnesses should be employed whenever possible and always in fast flowing rivers. Safety lines must be attended at all times by a Line Tender Team and not attached to a shore side anchor point.

The Line Tender Team will be supervised by the Line Safety Officer (LSO), who's responsibilities are:-

- The rescue swimmer safety:
- Be positioned to have overall control of the rescue swimmers line.
- To maintain visual and verbal contact with the rescue swimmer.
- Before the rescue swimmer enters the water ensure sufficient personnel are available to retrieve the rescue swimmer.
- Initiate emergency action if necessary.

The only task allocated to the LSO (whilst the rescue swimmer is in the water) will be to ensure safety of the swimmer and control of the line. Although it is not essential for the LSO to have direct contact with the floating line they must be in sole control of any personnel holding it.

Verbal and visual contact must be maintained at all times between the LSO and the rescue swimmer.

If either of these break down at any point during the rescue attempt, the LSO must initiate emergency action by withdrawing the rescue swimmer (if necessary by physically removing).

The Line Tender Team should position themselves upstream of the rescuer on one of the river banks. If the rescuer then loses his or her footing the current will swing the rescuer to the river bank and relative safety.

In no circumstances should the Line Tender Team work in parallel to the current as this could cause the rescuer to be held into the current and be drowned in the flow.

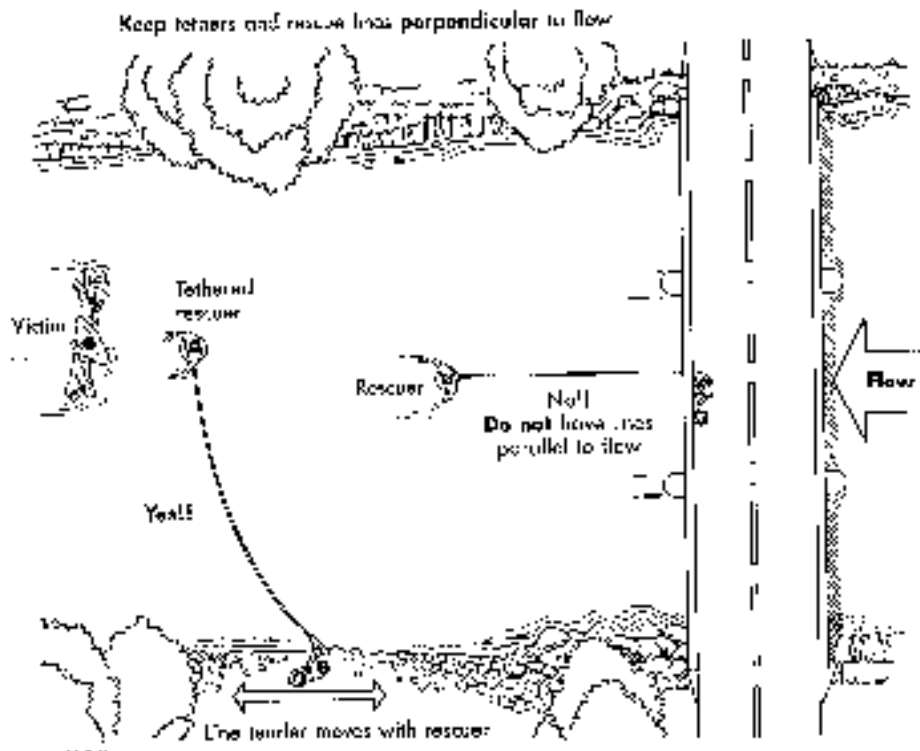

Water will flow deeper and faster on the outside of a bend and slower and shallower on the inside of the bend. This can be used to the advantage of the rescuer in getting near to the casualty but by remaining in shallow water.

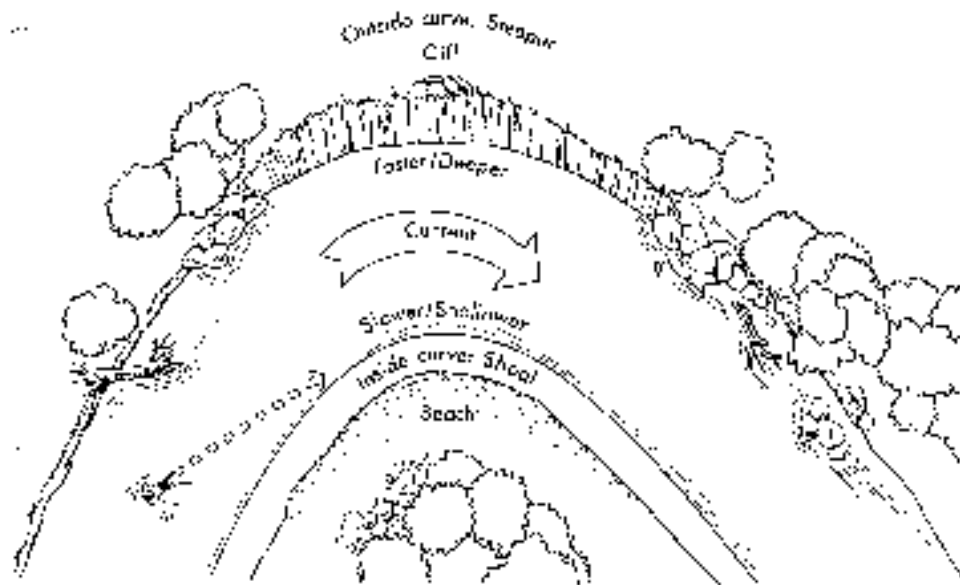

Risk Zone:

Most accidents result in drowning after a casualty slips, trips, or falls from the bank from within 3 metres horizontally from the water's edge, i.e., the 'risk zone'. To reduce the risk and provide a safer working area, all personnel required to work within the risk zone must be dressed in the minimum standard of Personal Protective Equipment consisting of:

- Full Firefighting Kit
- Life Jacket
- For 'lone' workers, e.g., pump operators who are working within the 'risk zone' a 'Restricting Line' should be provided (this should be anchored and restricted to a length that prevents falling into water).

N.B. The fire helmet should be removed unless there is a possibility of falling debris, in which case the chin strap should be unfastened (this is to prevent a neck injury in the event of accidental immersion).

A safe route should be identified and marked from the nearest access point to the scene of operations (Traffic tape may be used to indicate this route).

Any significant hazard that may cause injury i.e. trip hazards, should be clearly marked and identified to all personnel working in the vicinity.

Contact with the casualty

It is important to make contact with the casualty as quickly as possible. Keep talking to them, explain what you are going to do, what you want them to do and keep encouraging them.

Where possible it should be the aim of the rescuer to stay dry and not enter the water. Therefore, the talk, reach, throw principals already described should be adhered to.

Be aware of the local environment (See page 19).

Never let the casualty make direct physical contact with you.

If the casualty cannot use their arms, turn them on to their back and allow the shore team to tow you back using your safety line.

Offer the casualty a suitable flotation device and allow them to hold on to it as a buoyancy aid.

If the casualty is not conscious the airway must be maintained and where a neck injury is suspected then the head, neck and back must be supported throughout the rescue.

Resuscitation should be commenced as soon as practically possible.

Standard Operational Procedures - Summary

- Start dynamic risk assessment on receipt of call.
- Use preplanning information/local knowledge.
- Consider equipment requirements.
- Consider personnel requirements.
- Consider access/egress.
- Gather information.
- Review dynamic assessment.
- Formulate plan.

- Initiate plan.
- Establish risk.
- Consider specialist assistance.
- Prepare secondary plan of action.
- Post incident consideration

4. SUB SURFACE RESCUES/RECOVERY

Breathing Apparatus (BA) for Sub Surface Rescue.

Brigade BA must not be used under water. Personnel are not trained and the equipment is not designed for such use. It may be considered necessary to fit a BA face mask (with air supply) to a casualty trapped below the surface of the any 'unstable surface' to afford extra time to rescuers. However, firefighters must be able to achieve this without wearing BA themselves.

All activities of this type must be strictly controlled.

The risks associated with sub surface rescue attempts are considered to be excessive. It is not possible to reduce this risk to tolerable levels for firefighters. Because of this firefighters **MUST NOT** attempt sub surface rescues. However, there are certain situations, which may be considered as sub surface but because of their type, or location adequate control measures can be put into place to reduce the risk to within tolerable levels. Examples of this would be:

- **A person is in difficulty on the bottom of a deep swimming pool because hair or a finger is trapped in a grate.**
Although rescue personnel may have to 'duck dive' below the surface of the water to effect the rescue, safety crews can control the safety of the rescuer. The rescuer can be seen from the side of the water. The water environment is also considered to have few uncontrollable hazards and therefore this type of activity would be considered to be acceptable.
- **In open water where a casualty is in difficulty below the surface of the water.**
If the rescuer is able to stand upright in the water with the water at no more than shoulder level and is only required to place the head and shoulders beneath the surface of the water to attempt rescue, this will also be regarded as an acceptable practice. Simply by standing upright at any time in the water, the rescuer is again in a tolerable risk situation.
- **Where a rescuer is in open water attempting to recover a casualty who has just gone beneath the surface of the water.**
If the casualty is located touching part of the rescuers body, with rescuers head above water, an attempt can be made to recover the casualty provided the rescuer is able to do so without submerging totally below the surface of the water and the activity is rigidly controlled.
- **Where a vehicle has entered the water and submerged below the surface with occupants known to be trapped inside.**

If firefighters are able to work from a horizontal surface of the vehicle (i.e. roof, bonnet or boot) to affect the rescue without totally submerging below the surface of the water this would be regarded as an acceptable practice provided correct levels of PPE and rigid control measures are in force.

NB: Sub surface rescues in open water MUST ONLY be attempted when firefighters actually witness the casualty disappearing below the surface of the water. This activity must only be continued up to a maximum period of 10 minutes after the casualty is known to have disappeared below the surface.

5. ICE RESCUES

Incidents involving persons falling through ice are rare, however, research indicates that where persons do fall through ice, then the risk of loss of life is extremely high. Additionally, the risk to the would-be rescuer is equally high, if they are not properly trained or equipped.

Total cold-water immersion, or part immersion will, after an extremely short period of time, (about 4 minutes) render the victim into an almost helpless state. They will probably only have sufficient strength and co-ordination to cling to the broken, floating ice.

The problems and dangers faced by attending fire crews are:

- These incidents occur usually in the more remote areas and often provide difficult access to the rescuer.
- The Level 1 attendance will have limited equipment available to assist them to affect a safe rescue.
- Walking on the ice might easily result in the rescuer requiring to be rescued should the ice continue to break.
- People who have fallen through ice tend to be surrounded by broken ice that prevents the rescuer approaching directly up to them

Procedures for ice rescues

All ice rescues will automatically receive a Level 2 response, the inflatable rescue path (IRP) should be considered as the primary tool for this type of incident. Both ambulance and police controls shall be informed.

The principles of Talk, Reach, Throw, Row and Go apply, urgent consideration must be given to the use of throw lines and inflated hose to assist in stabilising the casualty.

The IC of the first attending appliance shall confirm with control the most suitable access route for supporting rescue vehicles.

The casualty may not be able to affect their own rescue; therefore, a Level 2 trained firefighter will have to make their way out to the casualty utilising the IRP.

The rescuer should ideally be a lighter member of the crew they shall always be a swimmer and confident in water. A safety line shall be attached to the rescuer.

6. MUD/SAND/CLAY RESCUES

People or animals may find themselves trapped in or on these unstable surfaces either when the surface is so soft that they simply sink to a point where movement becomes impossible, or they break through a layer of a relatively firm surface into a soft solution.

IN ANY EVENT, THE SURFACE PRESENTED TO A RESCUE TEAM WILL BE BOTH SOFT AND TREACHEROUS.

- Time spent on reconnaissance is never wasted. Consider the most effective route to the casualty. The route the casualty took might not be the best route for access and recovery. Poor conditions or difficult terrain may require additional personnel or equipment.
- All rescue activities should be controlled and coordinated by the IC from a safe working area on firm ground. A minimum number of personnel required to complete the task should be committed to the immediate area around the casualty. Access to a casualty may be difficult due to the soft surface of the mud, making walking impossible, the only effective method is to spread the weight as widely as possible across the surface.
- IRP's, ladders, inflated fire hose, salvage sheets and rescue boards/stretchers may all be useful tools for providing a safe working platform around the casualty. A boat may also be of value if the mud is adjacent to water.
- Initial activities should be directed to stabilisation of the casualty using lines and safe preparation for extrication. A safety line should be attached to all personnel working in mud. Each line should be under the control of an individual LSO.
- A BA set should be provided for the benefit of the casualty and account needs to be taken of any local tidal conditions.
- The area should be well lit. Artificial lighting must be provided to illuminate access routes and work areas where natural light is poor.
- An equipment recovery area should be set up on safe ground as part of the incident control area. Items of equipment should be immediately returned to the recovery area after use.

Rescue

There are only two principal rescue methods available - water injection or digging out.

Water Injection

An IRP should be laid out on the surface adjacent to the casualty to provide a stable working platform for the rescuers.

- A safety line and/or suitable strops should be passed around the casualty (under the arms where possible) to give support and prevent further sinking.
- A mud lance is placed down the sides of the casualty and around the body in a circular motion, this loosens the clinging mud/sand and breaks the suction effect.
- As the lance is being used, other members, working from the IRP, should attempt to pull the casualty clear to firm ground.

Digging Out

“Digging” is self-explanatory. However, considerable care should be exercised when working close to the casualty. It is likely that the casualty will be partially numbed by the mud and may not feel any contact with the spade. Serious injury may be caused that would not become

apparent until the condition of the casualty abruptly worsens, or they are evacuated and cleaned up.

7. ANIMAL RESCUES

Determine the condition of the animal and urgency of action, i.e., need for a vet or RSPCA.

The majority of incidents will involve farm animals, i.e., the release of a cow that has fallen into a slurry pit or a horse that has stumbled into a river. This type of rescue is potentially hazardous and the IC on arrival at the scene must put strict control measures in place.

It must be considered that in many instances animals manage to get to safety unaided after falling into water. Provided that the lives of firefighters are not unduly risked, attempts may always be made to rescue animals.

8. VEHICLES IN THE WATER

This information is designed to assist the Incident Commander to make an informed judgement on the appropriate actions to take and control measures which may be necessary at incidents where vehicles are positioned in, on or near water.

It is not a definitive guide.

It may also be necessary to use additional skills and techniques to deal with the incident, such as those related to Road Traffic Accidents on a roadway.

Incidents involving vehicles submerged in water may vary quite dramatically because of: -

- The type of vehicle - Car, LGV, Articulated, Laden/Unladen.
- The type of water hazard - Still, Flowing, Temperature, Depth, Flood condition.

Vehicle Behaviour

Initially, (even with all windows open) the average car will float for at least 45 seconds. The electrical system (lights, wipers, radio and power window) will usually still work even when a vehicle is full of water.

- Once a vehicle is full of water a number of factors will determine what happens next, such as, the nature of the riverbed, the surface current, weight and distribution of passenger or load.
- In flowing water if the vehicle is side on to the current on a solid riverbed a roll is almost inevitable. Even in slow currents a vehicle will be rolled a considerable distance if unimpeded.
- On a soft bottom, (mud, sand or small rocks) if the vehicle lands on its wheels, each tyre will create an eddy, scooping mud, sand, etc. out, so that the vehicle will settle onto its chassis.
- If a vehicle comes to rest more or less straight in line with the current, water pressure will sink the upstream end of the vehicle deeper than the downstream end.
- An eddy will be created on the downstream side of the vehicle providing rescue crews with a calm area of water to work from. However, strict control must be exercised over crews working in this area, as there is the potential for the vehicle to roll in the direction of rescuers.

- Anchoring a line to each side of it may reduce the risk of the vehicle rolling.
- If the vehicle is wedged against an obstacle the area of eddy is usually a safer area for crews to work from. Consideration should be given to the fact that the object/condition causing the vehicle to be wedged may move or change, thus allowing the vehicle to move whilst rescue operations are in progress.

Associated Hazards

- Slippery vehicle surface.
- Sudden uncontrollable movement of the vehicle.
- Entrapment of rescuers inside vehicle.
- Snags, sharp edges.
- Once the body panels of a vehicle are wet, they may be extremely slippery to personnel attempting to stand or place equipment on.
- Even in still water, movement of the vehicle load (passengers, etc.) or access onto the vehicle by rescuers may cause the vehicle to move.
- In flowing water use of a window punch or axe to break glass, enabling access, can cause drastic decompression. Do not use such tools to break a downstream window as this may cause a loss of internal pressure resulting in all the glass breaking and the possibility of occupants and rescuers being flushed downstream.

Where the vehicle is totally submerged below the surface of the water but rescue personnel are able to stand either on the vehicle or equipment bridged between the bank and the vehicle, this will not be regarded as sub surface activities.

Extreme care must be taken by anyone entering a submerged or partially submerged vehicle as the weight of water or vehicle fittings may cause entrapment inside the vehicle.

The vehicle may have sustained impact damage prior to, or as a result of, entry into the water. Glass or damage to body panels may have created numerous sharp hazards.

Rescue Considerations

Effective and continuous communications will play an essential part in the success of the actions taken. Firefighters must be fully briefed on the tasks they are to perform, including the aims and any control measure, which will be in place. Casualties need to be reassured and instructed on what to do to assist with any rescue attempt, in addition to being advised of the activities being undertaken by firefighters to rescue them.

When the vehicle is close enough to the bank side, it may be possible to wade through the water or to bridge ladders or use the Inflatable Rescue Path (IRP) to gain access to, or onto it.

If the occupants of the vehicle have managed to self-rescue and position themselves on top of the vehicle it may be possible to use rescue boards, inflated fire hose, throwing lines or a bridged ladder to stabilise or remove them.

Where the incident involves a vehicle submerged below the surface of the water and it is determined from a reliable source (Police or witness) that the vehicle has been in the water for a considerable time (in excess of 15 minutes), the Incident Commander should await the arrival of the specialist equipment to examine the vehicle and should not commit personnel prior to its arrival.

9. POST INCIDENT CARE

Even in the most minor cases the casualty should not be allowed to walk out with the rescue team. Sudden release and attempts to stand may induce post rescue collapse with possible fatal results. For this reason the casualty should be evacuated on the stretcher in as near a horizontal position as possible.

The Institute of Naval Medicine, Portsmouth, has provided the following information.

Survival times of people on the surface of the water, maximum water temperature of 15°C (59°F) can be categorised as follows:

Effect	Maximum Time Period	Outcome
Cold Water Reflex	2-3 minutes	Drowning
Swimming Fatigue	2-15 minutes	Drowning
Hypothermia	15-30 minutes	Death

N.B. Wearing a life jacket will not stop the above effects.

Cold-water immersion cools the body 27 times faster than static dry air temperature; this is multiplied by a further factor of 10 when swimming.

In cold water a good, strong swimmer will quickly be reduced to a non-swimmer because of the effects of immersion hypothermia.

Summer inland water temperatures are known to average between 10° and 15°C.

All personnel who have been immersed in cold water should be taken to a warm environment as soon as possible.

Brigade personnel should be removed from operational duties until they are thoroughly warmed, have dry clothing and their welfare has been suitably addressed.

Beware of hypothermia. Symptoms are shivering, slurred speech, lack of co-ordination and cold to the touch. If there is any doubt, seek medical attention. Remember, shivering ceases in the more advanced stages of hypothermia and so the lack of such shivering in isolation cannot be relied upon as to the welfare of the individual.

Non Brigade personnel, who are either casualties or rescuers, should be advised to seek medical advice. Any person who has been revived or was near to drowning should be conveyed to hospital. Secondary drowning can take place up to 72 hours later.

Further considerations

- Decontamination of personnel.
- Equipment retrieval.
- Equipment cleaning and testing on scene.
- Cleaning and testing of equipment at station.
- Remedial measures - reinstatement of fences, etc.
- Personal hygiene. *(Personal hygiene is important where crews have been in contact with open water, mud or similar. All personnel must wash and shower as soon as is*

practically possible after the incident and all equipment should be cleaned, tested and serviced in accordance with the periodic maintenance schedule).

- record details of those Fire Brigade personnel who have been exposed to possible 'contaminants'.
- Critical Incident Defusing should be considered for personnel involved.
- Incident debrief.

SUPPORTING INFORMATION

10. WATER RESCUES - HAZARDS

Firefighters spend a portion of their duties involved in activities working with and alongside water. Normally, this involves pumping from ponds, lakes and rivers, but on occasions they will be called upon to rescue persons and animals or recover bodies and other objects from water, sometimes in hazardous, time-critical situations.

It is essential that personnel appreciate the hazards associated with working in, or near water. These may be summarised as:-

- Current, flow, undertow, eddies, whirlpools, weirs, stoppers.
- Weight, temperature.
- Depth.
- Water clarity.
- Pollution/Contamination/Biological risks.
- Mud, Silt, Roots, Weeds and Rocks.
- Entrapment, debris/trees, fencing, car's, shopping trolleys.
- Panic of drowning person.
- Riverbank quay-side conditions (slips, trips, and falls).
- Surface vessel movements and water borne debris.
- Impacts from casualties and animals.
- Sprains and strains caused by over-reaching, pulling and lifting from unnatural positions.
- Drowning/Fatigue.
- Danger from action of bystanders.
- Equipment falling in.
- Electrical hazards - overhead power lines etc.
- Inadequate lighting.

The Operational Procedures Section of this document outlines the actions to be taken by crews to minimise the risk posed as a consequence of the above hazards. However, special consideration should be given to the following:-

Current/Flow

There are two types of current generated as water flows along a river:- helical flow and laminar flow.

- Helical Flow is the flow which causes the banks of the river to be undercut. The hazard provided by this current is that an object in moving water will tend to be swept away from the bank into the centre of the river.
- Laminar Flow does not provide a particular hazard in itself, but it is worth noting that it causes water near to the surface to move more quickly than water near the river bed.

Furthermore, at a bend in the river, water on the outside of the curve will travel faster than that on the inside.

Weirs/Stoppers

The hazards presented by these currents to a person or object in the water is that they will be drawn upstream towards the face of the weir by the tow back then forced under the surface, to be flushed out further downstream. In many cases the person or object is again caught by the tow back and circulated in a similar manner, rapidly becoming disorientated.

Weight of Water

The weight of water exerted against an object is directly related to the speed of the flow. A flow of 1m per second exerts a force of almost 8kgs on a person's legs (in depth of approximately 1 metre). If the flow doubles to 2m per second the force quadruples to 32kgs.

N.B. Double the water speed = quadruple the weight.

Thus standing in fast flowing water is extremely difficult.

Strainers

The main hazard associated with a strainer is that a person or object may be drawn against it and trapped by the weight of water passing through it.

Entrapment

A similar hazard to strainers exists where fast moving water flows against a solid object such as a bridge pillar. Although most objects will tend to be flushed around the obstacle, a swimmer or boat that hits side on can be pinned against it with considerable force.

Rocks or other debris below the water surface may cause entrapment hazards to personnel wading in the water. This is particularly hazardous in flowing water where the weight of water may also cause a loss of balance.

Local Environment

The local environment could have a profound effect on the situation and the following hazards should be considered in the operational risk assessment:-

- Fast flowing rivers and changes in water flow due to tidal conditions, heavy rain, and flash flooding may increase the risk. Conditions could change quickly and dramatically due to these effects.
- In tidal situations, local tide times and heights should be ascertained either locally or through Fire Control at the earliest opportunity.
- Particularly in quarries and around the coastline the bottom may shelve away very quickly, changing the depth of water from a few millimetres to 30 metres or more.
- Underwater obstructions and hazards may be unseen and personnel must take the utmost care when moving through water. It is best to adopt a shuffle as when wearing BA and some form of additional support such as a ceiling hook may be of use.
- Darkness will significantly increase the risk to rescuers and additional lighting should be provided. Rescuers should carry a lit torch or lightstick to enable the shore crew to see them. High visibility jackets may also be worn under lifejackets to increase visibility.
- Cuts and grazes should be cleaned and covered.

FAST FLOWING RIVERS

In any fast flowing water stream, various currents and eddies will be formed by obstructions in or under the water, thus changing the direction and speed of the flow.

These eddies can have adverse effects on a rescuer and must be considered in the dynamic risk assessment. Remember that waves on the sea tend to move and the water stays still but

in a river the waves remains in one place and the water moves. Therefore, eddies and currents can often be detected by the presence of such static waves.

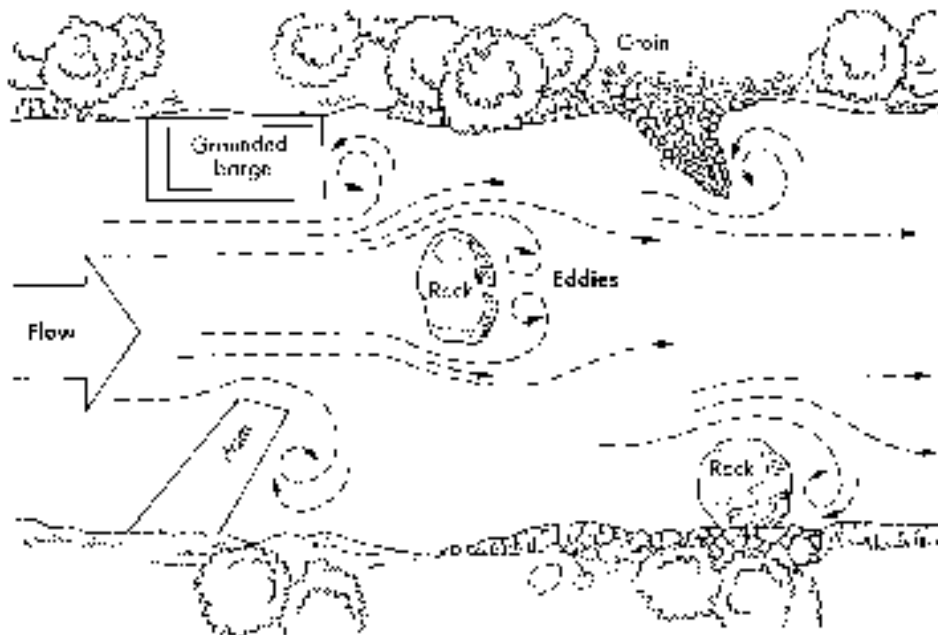

11. BIOLOGICAL CONTAMINATION

All open water is potentially hazardous and the risk to the firefighter may be increased by the presence of contaminants. The sources of such contamination are numerous, but stem mainly from the following :-

- Outflows from slurry pits and sewage/water treatment plants.
- Run-off from agricultural and industrial sites.
- Leaking fuel from submerged vehicles.
- Blue green algae (usually in summer months).
- Water borne diseases (see supporting information).

Biological contamination should be prevented wherever possible by taking the following actions: -

- Only enter the water if absolutely necessary.
- Wear immersion/dry suits.
- Personnel with open wounds should not enter the water.
- After the incident and before eating, drinking, or smoking, personnel should wash their hands using soap and water or detergent. Antiseptic wipes where available should

also be used once hands have been washed.

- Cuts and grazes should be cleaned and covered.

The foregoing shows that any water can provide hazards to firefighters. These can all be avoided by avoiding contact with the water in the first place.

The diseases most likely to be encountered are Hepatitis A, Gastro-enteritis and Weil's disease caused by a variety of bacteria and virus.' Weil's' Disease is carried in the urine of rats and other small rodents and is particularly prevalent in canals and rivers.

What can you do to protect yourself?

- Cover all cuts and broken skin with waterproof plasters before and during work.
- Wear protective clothing.
- Wash hands after handling any animal or any contaminated clothing or other materials and always wash before eating, drinking or smoking.
- Avoid contact with stagnant or slow moving water.
- Shower after becoming immersed in open water.
- Use footwear to avoid cutting feet.

What are the symptoms?

The first signs of Weils's Disease is a flu like illness within about 3-4 days of the infection. After 6-7 days a severe headache and conjunctivitis with the possibility of meningitis follows. At 8-10 days, kidney failure and the beginnings of jaundice will become obvious. If no treatment is given then severe kidney failure and the spreading of the organism to other major organs such as liver, pancreas and intestines can occur resulting in heart failure.

What you must do

If any of the symptoms develop - inform your General Practitioner of the symptoms and that you are at risk from Leptospirosis.

12. HELICOPTER OPERATIONS

The use of a search and rescue helicopter may reduce the risk to firefighters or remove the risk all together. Request for helicopter assistance will be channelled via Fire Control or Police officer on scene.

However, they carry their own inherent difficulties and the greatest care must be taken to protect rescuers, casualties and the public if a helicopter is to be used.

The following points should therefore be taken into account when requesting helicopter assistance:

Unless the Coastguard are in attendance it is unlikely that radio contact with the aircraft is possible. However, there is provision to speak to the Police helicopter and other air support using Brigade UHF hand held radio on channel 6, 69 or 70. The additional facility of VHF marine wave band hand held radios, used by licenced operators on channel 16, will give direct communication to search and rescue helicopter.

Rota down-wash.

Survey the area for loose materials and structures i.e. loose roof sheeting, sand, grit, etc. Also small items of equipment and PPE must be secured with particular attention paid to fire helmet.

Approaching The Aircraft

Never approach the aircraft when it is on the ground unless directed to do so by the aircrew, then follow their instructions precisely and try to remain in sight of the pilot when approaching. Do not approach from the rear, or side.

13. GLOSSARY

Body Recovery:	When a casualty is seen lying motionless on the surface of the water and no information is available as to the time of water entry or when a casualty has been submerged beneath the surface of the water for more than 15 minutes.
Buoyancy Aid:	An item that increases buoyancy in water.
	Buoyancy:- Floating ability Positive:- Will float on water Negative:- Will sink in water
Eddies:	Water flowing in the opposite direction to the main flow, occurring alongside or behind objects.
Flooding:	Where a river and/or drainage system is not able to cope with the excess of water causing urban or rural damage and threatening the lives of the public or animals.
Helical Flow:	The current, which draws water away from the banks of the river with a circular motion.
IRP:	Inflatable Rescue Path.
Laminar Flow:	Found mainly in the centre of the river and is the motion by which water moves forward.
Life Jacket:	Floatation device specifically designed to be worn by a person to add buoyancy and maintain the airway clear of the water.
Line Safety Officer	Supervises Line Safety Team, reports directly to IC.
Line Safety Team:	Dedicated team working directly to the Line Safety Officer.
Rescue:	The process by which a person is removed from the water and brought to a place of safety.
Rescue Board:	Purpose designed board with inherent buoyancy capable of supporting casualty and rescuer.
Risk Zone:	Wherever possible this should extend to 3m horizontally from the water's edge.
Stopper:	Where water flowing over an object causes a vertical reversal of flow, as with a weir.
Strainers:	Any perforate object placed or trapped in flowing water such as a tree or metal grating which allows the water to flow through it, is referred to as a strainer.
SOP	(Standard Operational Procedure). Designed to identify tactical and operational procedures to secure safe outcomes.
Sub surface:	Below water surface.

- Tow Back:** Water from downstream moves back against the flow towards the face of the weir.
- Water Emergency:** A short simple method of obtaining urgent assistance when Fire Service personnel are in difficulty.
- Weirs:** A pre-constructed dam across a river over which water falls to a lower level. As water passes over the edge of the weir, dropping from a high level to a lower one, it forces a space in the surface of the water at the base of the weir. Water from downstream moves back against the flow to fill this space.
- Whitewater:** Churning water that contains up to 40-60% of air. Too thin to swim in, too thick to breath in.
- WRI's:** Water Related Incidents

MARINE OPERATIONS. ~ ' Ship Firefighting'

Summary:-

The Brigade response to ships on fire including the voluntary response to any firefighting or rescue operation beyond the "low water mark".

Draft - March 2001

Further Information:-

Fire Service Manual - Operations ~Marine Incidents.
BIS docs. Marine Operations ~ 'Safe' Working On Or Near Water.
- Marine Operations ~ Use of Helicopters
Fire Control GI File 18.01. / File 24.

Contents	Page
INDEX:-	
KEY INFORMATION:-	
PRIMARY INFORMATION:-	
1.	
2.	
3.	
4.	
5.	
6.	
7.	
SUPPORTING INFORMATION:-	
8.	
9.	
10.	
11.	
12.	
13.	
14.	
15.	
16.	
17.	
18.	
19.	
20.	

SHIP FIREFIGHTING

KEY INFORMATION

INITIAL ACTION

For Offshore Operations ...see BIS.....Heloops.

SEABORNE TRANSFER:-

FULL PERSONAL PROTECTIVE EQUIPMENT
IMMERSION SUIT
LIFEJACKET

ON ARRIVAL:-

- CONFIRM ASSISTANCE REQUIRED
- ASCERTAIN CASUALTIES
- ENSURE STAND BY VESSEL OR HELICOPTER AVAILABLE
- DETAILS OF INCIDENT
- SHIP'S RESOURCES AVAILABLE, I.E. FIRE MAIN AND OTHER FIXED INSTALLATIONS
- LANGUAGE DIFFICULTIES
- MAINTAIN CONTACT WITH FIRE CONTROL
- SET INTO SUPPLEMENTARY WATER SUPPLY (PREFERABLY FRESH)
- RUN A LINE OF 70mm HOSE TO HEAD OF GANGWAY AND INSERT CONTROLLED DIVIDING BREACHING

SAFETY:-

CREWS MUST NOT WORK ALONE
BA TEAMS, MINIMUM OF THREE
REPORT BACK TO IC USING HANDHELD RADIOS OR SHIP'S
FIXED SYSTEMS ON A REGULAR BASIS (EVERY 15 MINUTES)
MAINTAIN CONTACT WITH STAND BY VESSEL/AIRCRAFT

LIFEJACKETS

THESE ARE TO BE WORN AT ALL TIMES EXCEPT WHEN IN A "PLACE OF SAFETY". IF WEARING BREATHING APPARATUS, DON LIFEJACKET FIRST.

RADIO AERIALS, SCANNERS

KEEP CLEAR, DO NOT TOUCH

MACHINERY AND ELECTRICS

SEEK ADVICE BEFORE TOUCHING. REMEMBER, THEY MAY BE REMOTELY OPERATED. DO NOT MOVE VALVES.

COMPARTMENTS

FIXED INSTALLATIONS

DETERMINE IF DISCHARGED. WEAR BREATHING APPARATUS. TAKE EXTINGUISHING MEDIA APPROPRIATE TO RISK.

EQUIPMENT

HAUL AND LOWER. DO NOT CARRY EQUIPMENT UP AND DOWN VERTICAL LADDERS. TIE OFF THE FREE END OF THE LINE. CONSIDER USE OF ALP.

SCENE OF OPERATIONS

CONSIDER THE USE OF TRANSFER LINES/GUIDELINES.

SHIP STABILITY

CONTINUALLY ASSESS STABILITY OF VESSEL, TAKING INTO ACCOUNT QUALITY OF FIREFIGHTING MEDIA APPLIED, MOVEMENT OF CARGO, QUANTITY OF WATER REMOVED.

PRIMARY INFORMATION

1. POLICY

Cornwall County Fire Brigade has one of the longest coastlines in England and Wales. It has several busy ports including Falmouth which is recognised as a 'natural port of refuge' for vessels within the South West approaches.

As well as meeting its statutory duty to deal with marine incidents affecting vessels 'alongside' and/or 'inshore', the Brigade also carry out 'offshore' ship firefighting.

'Inshore' is defined as the low water mark at normal tides including every accretion from the sea, whether natural or artificial, as defined in Section 144 of the Local Government Act 1933. Therefore, ship firefighting within this boundary is the legal responsibility of the Fire Authority. Accordingly, firefighting and rescue beyond the low water mark is only to be carried out by trained volunteers who have completed the Brigade or Fire Service College Marine Firefighting Course.

It is not possible to set out detailed arrangements for calls to ships on fire at sea due to the variety of circumstances which can arise. The purpose of this policy is to provide guidance on the procedures to be adopted and considerations to be borne in mind upon the receipt of a request for assistance both inshore and offshore.

Subject to the final decision of the Chief Fire Officer, the Brigade will undertake firefighting and rescue at sea in the vicinity of the Cornwall coastline. All circumstances will be taken into account before making a decision, including weather conditions, state of vessel, nature of the hazard and any risk to life.

It should be borne in mind by all concerned that when the Brigade is to be involved in firefighting at sea, the speed and scale of mobilising response will normally be different from land operations.

Quite some time could elapse between the Brigade receiving a request for assistance and the decision of the 'Strike' or 'Assessment Team' Commander to involve the services of the Brigade. It is for this reason an agreement has been reached with the Maritime Coastguard Agency (MCA) to notify the Brigade of any incident of fire aboard ship near to or approaching the Cornwall coastline. This information may not be a call for assistance, but will allow the Brigade Principal Officer to prepare for such eventuality.

Specialist ship firefighting equipment, over and above that held at some port stations, is located at Falmouth Fire Station which will also generally be used as the base for mounting offshore operations. However, this may have to vary due to the location of the incident and the availability of suitable transport.

The location of the incident and weather will, to a considerable extent, decide the course of action. For calls to the North of the county's coastline, there is little seaborne transport available and, weather conditions permitting, a request for helicopter assistance may have to be considered. For calls off the South coast and within striking distance of Falmouth, a suitable vessel will be made available. This will normally be a tug from the Falmouth Towage Company, however, the Harbourmaster has a number of vessels at his/her disposal.

For a confirmed 'offshore' incident the Brigade will also advise other 'participating' Brigades in accordance with details held in Fire Control (GI File 18.01)

2. COMMAND AND CONTROL

Due to the nature of ship firefighting, for a confirmed 'ship', fire be it alongside/inshore or offshore the Incident Commander (IC) will nominate an Operational Commander (OC) to act as the onboard commander. The IC will normally remain ashore at the Command Point (CP)

3. CO-ORDINATION / LIASON

Ship firefighting at sea requires close co-operation and co-ordination of the various services involved. It may normally involve the Brigade, MCA, Harbourmasters, Dockmasters, RNLI, the Royal Navy, and Shipping Agents.

MCA (HM Coastguard)

The main role of the MCA is to co-ordinate all civil maritime search and rescue operations around the coastline of the United Kingdom and will, therefore, be the responsible authority for all co-ordination and communications between the relevant organisations. In certain circumstances the Royal Navy may assume this responsibility.

The Senior Coastguard Watch Officer at Falmouth Maritime Regional Control Centre (MRCC) and/or Brixham Maritime Rescue Sub Centre (MRSC) will routinely report to the Brigade on fires reported aboard commercial vessels, excluding small fishing vessels.

Such reports will be for information only, and as such must not be construed as a formal request for assistance unless so specified. This agreement has been reached in order to pre-alert the Brigade Principal Officer and also Falmouth Fire Station (for a potential offshore response) to a possible subsequent request for assistance.

The exception to this would be the onset of a major emergency, such as a burning passenger ferry, when Fire Brigade assistance would be sought as part of Search and Rescue (SAR) action in accordance with Falmouth Region Emergency Contingency Orders (FREMCOs).

Although the MCA has no authority to become involved in salvage operations, Rescue Centres do have a monitoring and reporting role in connection with actual or potential oil pollution at sea, and a remit to inform the Secretary of State's Representative (SOSREP) of any event likely to cause pollution, so that he/she can exercise his/her powers under current legislation.

At the onset of an incident at sea, and following a request for assistance, the Coastguard have agreed to an adhoc meeting being convened at Falmouth MRCC involving:-

- Coastguard.
- Cornwall County Fire Brigade.
- Falmouth Harbourmaster.
- Shipping Agents.
- Any other interested party.

The purpose of the group would be to determine the course of action to be taken and would assist towards advising the SOSREP of any pollution risk at the earliest opportunity, thereby negating any possible delay in attacking the fire.

In the case of fires at sea, HM Coastguard will arrange the transport requirements for conveying Brigade personnel to the vessel. (See also BIS ... Helops)

4. FIRES ON VESSELS ALONGSIDE/INSHORE

Although a vessel that is beached/grounded is not classed as 'alongside' the incident may be dealt with in the same way, bearing in mind the state of the tide.

The Crew Commander of the first attendance should liaise with the appropriate ship's officer. The remainder of the crew should give consideration to setting into a hydrant, preferably freshwater, on the quayside and running a line of 70mm hose to the vessel. If possible, a controlled dividing breaching is to be inserted so that firefighting can be carried out using 45mm hose.

Egress off of any vessel is a priority. At an early stage a second method of evacuating the ship, other than the gangway, must be established. If this is to be a pitched 135 ladder it must not be lashed due to the rise and fall of the tide. The Incident Commander should also consider using an Aerial Ladder Platform (ALP) for transfer of personnel and equipment from the quayside onto the vessel.

A Command Point must be set up and Embarkation procedures introduced. (See Section...)

5. FIRES ON 'SMALL CRAFT'

Small craft are those vessels which may be found in any of the small harbours, marinas and inlets around Cornwall. They range from small fishing boats to yachts and motor launches and are usually under 15m in length. The majority will be Glass Reinforced Plastic (GRP), construction, some will be traditional timber, whilst others may be built of steel, aluminium or even concrete.

Personnel responding to incidents on small 'pleasure' craft must consider that the vessel may be used as sleeping accommodation.

The close moorings of vessels in a marina or the mooring side by side, (rafting) of vessels, can lead to fire spreading rapidly from one craft to another. Success in preventing the spread of fire in these situations will depend on the speed with which the crews are able to respond and attack the fire.

The knowledge of experienced boat owners who may be in the vicinity should be considered by the IC.

6. FIREFIGHTING ON MILITARY VESSELS

These arrangements apply to all Royal Navy (RN) Royal Fleet Auxiliaries (RFA's). Foreign Navies who visit our ports may have different arrangements and security measures.

On arrival at an incident

A clear space (7.5m radius) will be maintained near the front of the gangway leading from shore to ship and clearly marked "FIRE BRIGADE ACCESS - KEEP CLEAR". Where more than one gangway is in position the "ON" or access gangway will be indicated by a red flag.

On arrival, the Senior Fire Brigade Officer will be escorted to the ship's officer responsible for the ship's safety for briefing on the situation and consultation regarding firefighting strategy.

RN officer responsible:-

Officer of the day (OOD)

Duty deck officer (DDO)

RN ships and submarines

RFA ships

Following joint consultation the OOD or DDO will either retain responsibility for firefighting operations or formally delegate those duties to the Senior Fire Brigade Officer.

Ships Officer retaining responsibility for firefighting

In this situation Brigade attendance will be maintained on standby until no longer required. Brigade personnel may be requested to provide supplementary assistance. The Senior Fire Brigade Officer will remain at the ship control for consultation and liaison purposes.

Fire Brigade delegated responsibility for firefighting

There will be a formal delegation of responsibility to the Brigade Senior Officer and he/she will be requested by the ship's officer to undertake firefighting operations.

Ship Safety

Full overall responsibility for the safety of the ship will be maintained by the RN/RFA Commanding Officer (or his/her designated representative) **irrespective** of who is undertaking firefighting operations. The main priority of RN/RFA vessels is ship safety and, during initial joint consultations between ship officers and Fire Brigade, it may be decided that firefighting will take preference to search and rescue operations

Communications.

Brigade personnel will normally utilise Fire Service communications equipment but, in some instance, radiation hazards (RADHAZ) may prohibit its use. Communications Liaison Officers will be appointed from each service to the others control point.

Route to Fire

Ships personnel will identify the route to the fire by laying a combined 'transit' and communications line.

Control of Personnel

Each service will operate under the direction of their respective service officer. Where firefighting operations are Brigade controlled, any use of RN/RFA personnel will be by agreement with the ships officer responsible for safety (i.e. OOD or DDO). In this situation the Senior Fire Brigade Officer will be responsible for the health and safety of all such RN/RFA personnel.

Withdrawal of Personnel

Where firefighting operations are Brigade controlled, RN/RFA personnel will gradually be withdrawn from the fire area as Brigade personnel replace them and will normally operate in BA, in pairs, acting as guides.

Electrical Supplies

Where ever practicable, electrical supplies will be isolated, especially those in excess of 440 volts. For voltages below 440 volts a "keep alive" policy may be in operation.

Breathing Apparatus

Where firefighting operations are Brigade controlled, overall co-ordination and control of all BA wearers will be exercised by the Senior Fire Brigade Officer present.

Ship's Emergency Refit - Falmouth Ship Repair

During unstaffed refits the responsibility for fire safety and firefighting services will rest with the repair contractor.

Whilst unstaffed refits within Falmouth Docks are unlikely, vessels will generally be operating with skeleton crews only.

7. STANDARD OPERATIONAL PROCEDURE (SOP) FOR OFFSHORE INCIDENTS

'Offshore' is described in Section 1 and may include any vessel that is not in a harbour or dock area and which requires the conveyance by boat or air of crews and equipment to it.

If a 'request' is received at station level it must be taken down and passed to Fire Control with any other available information. Any information received by Fire Control which has not come via MCA must be immediately passed to them.

On receipt of a request for assistance any suitably qualified person from Falmouth Fire Station will be sent with the Liaison Officer's guidance pack to the MRCC at Castle Drive, Falmouth, to act as initial Fire Brigade Liaison Officer. A Supervisory Officer will also be sent to act in a potential Command Support Function.

The Liaison Officer's will act as the link between the Fire Brigade and the other services to facilitate effective communications and response.

The definitions/criteria for response teams is identified in BIS ... Helosop. Sec4.

However, for a seaborne response the following must be considered.

The MCA will arrange suitable transport from the embarkation point.

The Party may also include experts from other maritime organisations such as the Harbourmaster, Dockmaster, Ship's Agent and a ship surveyor. All of these experts can assist in arriving at an early determination on the extent and severity of damage, pollution hazard and any problems that may be encountered with the stability of the vessel. (All of these factors will help to determine if the vessel can be brought into port or sheltered waters to allow firefighting operations to commence). The decision arrived at will be a joint decision by the interested parties, however, the final decision will lie with the Harbourmaster who has responsibility for the safety of the Harbour Area.

Fire Brigade Control ~ Actions

On receipt of the initial call from the MCA, Fire Control will commence a log for the incident and advise the Brigade Principal Officer (PO). Fire Control should confirm with the MCA that the 'Tasking Form' (See Helo BIS) is being dispatched.

A procedure must be in place within Fire Control to ensure the appropriate mobilization actions are taken and recorded. (GI File 18.01)

Some of these procedures may, by local agreement be cascaded to key stations e.g Falmouth or other experienced personnel.

Preplanning considerations

The PO, on receipt of the (a) initial call details and (b) 'Tasking form' will then consider the strategy options for a possible response. These options may include:-

- adequate information available
- risk versus benefit
- transport availability
- ability to evacuate
- weather/sea conditions
- environmental impact
- financial cost to Brigade
- assistance from other Brigades

An MCA 'Liaison' Officer must be sent to the nearest MRCC at the outset of an incident, and work closely with a dedicated MCA/Fire Liaison Officer. This is a Command Support function, and may well be supported by a Senior Officer (Functional Commander) as the incident expands.

As an 'aid to civil power', military resources may be made available to fly teams from neighbouring Brigades to assist.

When it is known that teams will be deployed a 'Functional Sector Commander (Welfare)' should be introduced shoreside to consider issues for well being of friends and family etc..

Strategy, Tactics and Operations

It must be remembered that Command and Control is of the utmost importance and is required for all incidents. It may, itself, not be in place until sometime after a receipt of the initial call and it is likely that modes of transport to and from the incident will differ with personnel travelling to the incident by helicopter and returning by sea borne transport. It is essential that a system of Command and Control is initiated at an early stage, that it be constantly updated and be available to all necessary Fire Brigade departments and locations as well as outside agencies where applicable, i.e., MRCC.

The PO must be aware of the implications of a prolonged incident, which may impair the ability of the Brigade to react elsewhere.

Identification of the 'Command Team'

The 'Command Team' are the key officers who determine tactical and operational decision making

The 'Command Team' will form part of the 'Strike Team' and may form an assessment team. They are identified as indicated in accordance with the ICS .

To limit spans of control and maintain good lines of decision making this Command Team must maintain regular communication in line with the agreed principals of the ICS. They are also responsible for ensuring that key information is cascaded around the incident on a regular basis...every 20 minutes normally, to ensure ALL personnel involved have a full understanding of the situation.

Onboard the vessel the OC is responsible for determining 'Tactical Modes'

Chain of Command.

Notably as previously indicated the IC will remain ashore as the 'eyes and ears' of his/her Operational Commander (OC) on the casualty. This acts as an intermediate 'Strategic' level of command between the 'Tactical' OC onboard the vessel and the overall Strategic Commander, ie., the Principal Officer (PO).

The IC may move to the MRCC along with his/her Command Support Team. (This may be a Command Vehicle).

Response Teams

On receipt of a call for assistance, a procedure should be in place to 'put on alert' the appropriate teams. This will pre-empt a confirmation from the PO, but in the event of a "no-go" decision, it is easier to stand crews down.

The carrier (SAR or TUG) must be advised of response time to embarkation. This applies in the event of an 'Assessment' or 'Strike' team(s) being mobilised.

'Support Team's' and Equipment (Seaborne)

Will be as prescribed by the Operations Commander following his/her tactical risk assessments. The numbers may be varied according to the instructions of the OC but should not exceed 20 including those firefighters already aboard.

Criteria for SAR helicopter operations.

See also BIS.... Helops.

The MCA 'Tasking Form' and Brigade Nominal Role sheets should indicate details regarding air assets, in particular:-

- Type of aircraft, both initial and secondary flights.
- Seat/weight capacity.
- Aircraft recognition/call sign.

Embarkation and Transfer

When a call for assistance has been received by the Brigade and it is decided to send a response, all personnel will report to Falmouth Fire Station.

Here they will be briefed on the offshore of the incident and all safety issues by the Crew Support Officer and will be issued with an embarkation tally by the Embarkation Officer with their name/rank and number written on it in chinagraph as in any BA procedure. The crew will then embark from 3.1 Falmouth to the embarkation point, after taking issue of safety equipment, i.e. life jackets, immersion suits, welfare bags, etc.

Upon arrival at the casualty the personnel will report to the Boarding Control Officer (Board must go with first team and is held at access / evacuation point onboard casualty to identify persons on board) and hand their tallies to him/her. No person will be allowed onto the vessel unless they have a tally. When personnel are about to leave the vessel to come ashore they must report to the Boarding Control Officer and collect their tally.

Once ashore, they must then report immediately to the Embarkation Officer at 1 Falmouth and return their tally to him/her.

To ensure safety, the above procedure must be rigidly adhered to so as to maintain strict control of the numbers, movements and identity of personnel in transit to and from the casualty. The IC must ensure at all times that he/she is fully aware of the numbers of persons being transferred etc and continually ensure tactical messages are updated via the MCA.

Prior to embarkation on the 'transport' the IC and OC must communicate and confirm all procedures and R.A.'s have been dealt with

Ship Command Wallet / Board - for recording of tactical information will also go with first team. The wallet must contain the appropriate tabards for OC / CS / SC / SO as previously identified i.e

- OC Red
- CS Red and White chequered
- SC Red and Yellow
- SO Blue and Yellow

The OC will confirm all previous details with flight crews prior to embarkation.

The OC must have headset communication with the pilot for the duration of the flight. All tallies must be identified by personnel - boarding board must go with first team.

Prior to flight, all crews must be given a flight safety brief. This should normally be completed at the departure point prior to arriving at the embarkation rendezvous.

All crews must be fully checked for PPE, etc. The OC must be clearly identifiable to the aircrew.

On arrival

A DRA is carried out by both pilot and OC when arriving on the scene, eg., fly by. Should the situation be unacceptable then fire teams will not be lowered to the deck. (MCA must be advised.)

Initially the OC and CS may winch to the deck to carry out an further initial DRA. Communication must be maintained with the aircraft.

In attendance.

Once aboard the vessel the OC should make contact with the Master (or other responsible person in the absence of the Master) and confirm Fire Brigade assistance is still required. Confirmation of this must be recorded with Fire Control via MCA.

The OC will liaise with the Master re: tactics and proceed to continue with the DRA process in an effort to determine tactics.

Initially, due to limited resources a 'defensive mode' will normally be maintained.

NOTE: For the purposes of offshore incidents the tactical mode is 'defensive' until crews employ Fire Brigade equipment in 'an identified risk area' that may then be determined as the 'inner cordon'.

Onboard Command and Control.

The Sector Command points are reference points for the Operational Commander from which the relevant SC's will command. (as for land based incidents) Instead of being identified numerically marked, they will be identified by the 'part of ship', e.g., forward' sector.

The Sector acts as a cordon control point and monitors personnel within it. It is not responsible for total command and control on the whole ship, this remains at the Command Point (CP) where overall monitoring takes place. In normal circumstances this would be the bridge of the vessel.

The siting of a CP is determined by the OC on consultation with ships Officers. This should take account of providing for a good advantage point from there the weather deck and most of the superstructure could be clearly viewed, also that communications systems would be readily available along with ships plans. Therefore the natural command point for ship officers and the position from which they would detail their initial actions.

Command and Control procedures should clearly take account of evacuation procedures and evacuation points should be clearly defined at all incidents and agreed by the OC any early stage.

A 'Transit Line' should be laid from SC points to the embarkation/evacuation position. A good ICS always supports regular briefings to all crew members, and good communications is a key factor in successful command and control.

The 'command team' are the key decision makers and no person should influence key tactical decision making without consultation to the command teams.

Should the 'OC' determine that 'offensive' tactics need to be deployed, this must be done by recognising that the strategy for implementation has been agreed with all concerned and that resources are adequate to deal with any escalation that may result.

Sector Commands.

Once resources are in place, eg., 'Support' teams or adequate combined fire/ships teams it may then be possible to 'sectorise' the incident.

Sector Command Points (SCP) need to be set up near the point where 'offensive' actions may take place or as a point of reception for 'defensive' tactics, eg., boundary cooling, containment, etc. The SC must be in contact with (a) the OC at the CP and (b) other SCP's

'Cordon Control'.

At all incidents a level of 'cordon control' must be put in place, on small craft this may be the entire vessel and therefore the Boarding Officer's nominal role board will be the controlling factor overall .

On larger vessels an inner and outer cordon may be established and the use of a Command Wallet each Sector Command Point should be considered to enhance control. The command wallet should contain numbered armbands to issue, with a safety brief to non Fire Brigade personnel.

An inner cordon refers to an area or section of the vessel which demands a greater degree of control, e.g., the immediate risk area, and may be clearly defined by watertight bulkheads , decks , compartments etc. All personnel must be aware of the areas within the inner cordon and all plans must indicate this. Any person working within the inner cordon, service or non service must be logged in and out at the Sector Command Point

Communications.

It is clear within the Memorandum of Understanding between Fire Brigades and the Coastguard agency that the Coastguard Agency maintain the overall co-ordination role for all offshore incidents. Communication is vital and must be channelled in all cases through the MRCC etc .

Incident communications would normally be under the direction of the OC. Communications between the incident and the MRCC would normally be by way of marine band radios as is contact between helicopters and any waterborne craft that carry fire teams.

Brigades must remember that direct communications between the incident and Fire Brigade Controls should not go ahead and that all messages and communications must be channelled through local MRCC's for onward transmission to Fire Brigade Controls through Fire Brigade Command Support 'Liaison' Officer at MRCC.

Other agencies.

Whilst the role of the Fire Service is difficult and sometimes, dangerous the challenges of an incident whilst at sea are finite and usually fall within a fairly short time scale.

There are implications for other agencies with regards, for example, fatalities, loss of personal possessions, cars, luggage, seriously injured casualties, anxious relatives. The never ending request from the media, national and local government hierarchy, inquiry boards, environmental agencies, Department of Transport, and local inspectorates and insurers. All will have implications for shore based agencies which are more diverse and will need to be sustained for a much longer time.

SUPPORTING INFORMATION

8. GENERAL OPERATIONAL PROCEDURES

All personnel who are to be engaged in Ship firefighting operations must first be adequately briefed as to the situation and reminded that life jackets are to be worn at all times whilst being transported to the vessel, and when working near the water.

Before boarding a vessel on fire the OC should introduce an ICP with a Command Wallet and Boarding Officer who will be responsible for recording the location of all Brigade personnel aboard.

The OC must liaise with the Master and/or First Officer and Engineer as soon as possible and confirm and record whether Fire Brigade assistance is required. The OC should be guided by their knowledge of the vessel and the effect of firefighting operations on the stability of the vessel.

Prior to engaging in any firefighting operations, crews are to be fully and formally briefed as to the situation and the actions planned. Similarly a formal brief of all support crews is of paramount importance.

During firefighting operations a support vessel should, at all times during operations, be moored alongside to maintain safe egress for firefighters.

The welfare of crews at a ship fire is most important due to heat stress when firefighting in BA. It will therefore be necessary to consider dry clothing and hot refreshments for crews. These are provided in the equipment packs. Due to possible inclement weather conditions it will also be necessary to provide shelter for crews resting from firefighting duties.

Ship Stability

Unless the fire is of a minor nature and controlled in the early stages, the OC must be aware of the effects of firefighting water being introduced into the ship which could affect the vessel's stability.

Crews must not wait until the stability of the vessel is obviously affected before establishing stability procedures, and very early liaison with the Ship's Master is essential.

The responsibility for a ship's stability falls upon the Ship's Master and his/her officers. In their absence the responsibility may fall on the Fire Officer in charge of the incident. In these circumstances the IC/OC should take advice from the Master of the salvage tug or any assisting vessels and/or the Brigade Stability Officer.

Safety During Transportation

Personnel travelling by helicopter or water borne transport or engaged in firefighting or special services afloat will wear life jackets at all times, except when in a place of safety or where the wearing of life jackets could create a danger. Life jackets are issued to stations likely to be involved in ship firefighting. Additional life jackets will be mobilised as necessary dependent upon the numbers of personnel involved.

Where BA is required personnel will not rig until they are actually aboard the vessel involved in the fire. Life jackets must be donned before the BA set so that the BA set can be quickly removed in an emergency.

During rough weather great care must be exercised when disembarking from a small craft onto the ladder of a ship or jetty. It is advised that when stepping from the small craft to a ship

or jetty this is done whilst the craft is at the peak of its rise. Similarly, when stepping off a ladder onto the craft it should also be done when the craft is rising.

With the exception of lines, equipment is not to be carried up and down ladders, alongside ships or jetties, but is to be hauled up and lowered as the case may be.

Lines which are being used to haul aloft or lower equipment should have their free ends secured to an immovable object.

Many vessels, especially those used for transportation, are likely to have their decks obstructed by lines and equipment. Therefore, personnel should exercise great care when moving about.

General Safety Precautions On Board Vessels

Firefighting personnel should keep clear of high frequency radio aerials which may carry dangerous electrical currents. Radar scanners should also be avoided as they may emit radiation, in addition to the more obvious hazard of being struck whilst the radar scanner is rotating.

All equipment taken on board ship should be secured against the roll of the vessel, especially in heavy seas.

Touching machinery on board vessels should be avoided as although initially it may not be running, it may be started by a remote device, such as a thermostat, pressure switch or time clock.

Electrical voltage on board vessels may range from 24 volts d.c., to 3000 volts a.c. (and even higher in some electronic equipment). Therefore, advice must be sought from a competent person before any part of the electrical installation is touched.

Before entering any cargo space or hold, it should be ascertained that it is gas free. Should there be any doubts, BA must be worn.

When working aloft or near the ship's side, personnel must be secured by line.

Raking ladders leading to engine or boiler rooms are normally comparatively steep, therefore it is advised that ladders are descended facing the treads.

Decks of machinery spaces are in some circumstances extremely slippery. Great care should be exercised when walking on them.

Cargo, as a result of fire or listing may collapse, therefore personnel should be aware of this hazard.

Some spaces are protected by automatic CO² installations. Whilst personnel are in such spaces and there is a possibility of the system operating, it is to be made inoperative, and a member of the Brigade positioned by the controls. The system is not to be reinstated without the explicit orders of the OIC. If it is not possible to make the CO² installation inoperative, personnel are to wear BA.

Smoking is not allowed in any part of the ship except during the rest period, in a safe area, at the discretion of the OIC.

No valve must be moved without prior permission from a competent person.

Fire kit which is worn by Brigade personnel retains air. This will act as a buoyancy aid for any personnel should they fall into the water. The following points however, should be remembered:-

- Attempt to discard fire helmets prior to entry into the water. (Helmets can be replaced once in the water to conserve body heat and to provide protection from falling objects).
- As much air as possible should be trapped in the tunic.
- Fire boots must be removed as soon as possible.
- Excessive movement should be avoided, as this will cause the air trapped in the tunic to escape and thus reduce body temperature
- Once in the water, move away from the vessel and keep together. Fully inflate the life jackets if not already done so.
- This is not a substitute for a life jacket.

9. Communications

The MCA is responsible for co-ordinating all information received by any means, from any source. It has access to all marine channels, including those used by harbour launches, pilot boats, tugs, Customs launches, MCA vessels, ships at sea and rescue helicopters. It is imperative therefore that messages between vessels, units and shore Authorities should be passed via the MCA network by a qualified operator.

Communications Equipment

Cellphone: A portable cellphone working on the Vodaphone network will provide good coverage in all areas of Falmouth Bay. Fire Control will mobilise a cellphone with the first attendance.

UHF Hand Portable Radio: UHF hand portable radios will provide on ship communications on Channel 3 and ship to Fire Control/Control Point on Channel 7 via the VHF repeater situated at station 3.1 Falmouth.

Marine Band Radio: Messages should be passed through MCA using marine radio on the transport vessel or vessel requiring assistance, via Channel O or other working channel designated by MCA during the incident. Marine Band Radio is only permitted to be used by a licensed Marine Band Operator.

Hard Wires As Carried on Rescue Tenders / Field Telephones from CSV

The MCA have provided a Marine Band hand held radio (call sign "Falmouth Whiskey" which has been allocated for Brigade use for emergency ship to shore/ship/aircraft communications. The radio is held at Falmouth on permanent charge and will be dispatched with the Operations Commander. A complete set of operating instructions is provided and the radio procedure detailed therein must be adhered to.

10. Key Command Team Functions

Incident Commander

Onboard Operational Commander

Before boarding a vessel on fire the Operations Commander should appoint a Boarding Control Officer who will be responsible for recording the location of all Brigade personnel aboard.

On arrival at the casualty vessel, the Operations Commander of the Strike/Support Team will confirm with the ship's Master that the Brigade's assistance is required and record this request. The Operations Commander should be guided by the professional advice available and conduct his/her own dynamic risk assessment. The Command Support Centre at Falmouth must be advised of all information in relation to the Tasking Form.

Operational Commander Considerations

You are now on board the Casualty:

- Advise MRCC and IC of arrival and numbers onboard.
- Liaise with Ship's Master and/or First Officer and Engineer as soon as possible.
- Establish an evacuation/abandon ship muster POINT and procedure. Brief fire team.
- Establish a communications point at - normally ship's BRIDGE.
- Check communication links with MRCC, Command Support Centre, Support vessels and crew.
- Survey incident - crews must work in pairs.
- Ensure stand-by vessel/ SAR available for egress.
- Check fixed installations availability.
- Consider location of forward control point.
- Dynamic risk assessment re-evaluation.
- Maximise use of ship's personnel - guides etc.
- Prepare for Support Teams if 'Offensive' Tactics are being considered.
- BA Teams to be minimum of three.
- Establish rest and recovery area near evacuation/abandon ship muster point if possible.
- Maintain 20 minute briefings with all personnel/MRCC/Command Support Centre or Liaison Officer at MRCC.

Communications Officer

Will act in a Command Support Role and be stationed at the Command Point.

The duties include:

- The setting up and maintaining the Marine Incident Wallet.
- Establishing and maintaining communication link with MRCC.
- Co-ordinating and maintaining communications with the Operations Commander, Boarding Control Officer, Sector Commanders and other Command Team Members.
- Facilitating the flow of information/messages to and from the Operations Commander.
- Updating and maintaining incident information boards throughout the incident.
- Maintaining a plan of the incident, indicating Sector Officers, Sectors and Crews location.
- Maintaining an overview of all resources and equipment at the incident.
- Establishing appropriate resource controls (holding areas, briefing areas, relief areas, equipment pools, etc.)
- Maintaining liaison with the ships communication officer where available.

11. Functional Roles

Stability Officer

Except for a minor incident, a will be nominated. (The Brigade has qualified stability Officers who will be notified by Fire Control to attend the incident). A stability procedure will be introduced as soon as possible.

It will be the duty of the Stability Officer, in co-operation with the ship's Duty Officer (if available), to maintain the stability of the vessel. (See Stability packs)

Embarkation Officer

DUTIES: Role is to co-ordinate all shoreside support operations with regard to personnel and equipment and to set up the various communications links.

RANK: Suitably qualified Falmouth personnel

LOCATION: Command Support Centre / CSV.

ROLE:

- Confirm availability of ship firefighting volunteers (recall to duty).
- Prioritise for second flight.
- Establish and maintain communications with:
 - Brigade Control
 - MRCC via Liaison Officer
 - The Casualty
 - Seaborne response carriers
 - RNAS Culdrose
- Nominate: Crew Support Officer
Loadmaster
Initial Liaison Officer
- Gather and record relevant information regarding incident.

- Co-ordinate Strike and Support Teams plus reliefs.
- Collection of nominal roll boards and Officer tallies (including keys).
- Issuing and recording embarkation tallies.
- Completed nominal roles of deployed personnel must be passed to Fire Control and MRCC.
- Listing of all equipment sent to casualty and specialist equipment availability.

Embarkation Marshall Assistant

To assist an Embarkation Marshall should be appointed who will oversee all aspects of quayside activity and assist the Embarkation Officer.

RANK: Suitably qualified Falmouth personnel

EQUIPMENT: 1 x Surcoat
1 x Embarkation Marshall's pouch
Transport as required
1 x hand held radio

LOCATION: Embarkation point.

ROLE:

- Establish a communications link with the Embarkation Officer.
- To transport equipment and personnel and supervise all quayside activities.
- Transport seaborne crews and equipment to quayside.
- Supervise the loading and off loading of personnel and equipment at the quayside.
- Transport disembarking crews to station.

MRCC Liaison Officer

Will be mobilised to attend the MRCC centre at Falmouth.

He/she will act as the link between the Brigade and other services involved in the incident and ensure that effective communications are established.

This role will be undertaken initially by any suitably qualified 3.1 personnel prior to support being given by a supervisory Officer who may then fulfil a more broad based command support function.

RANK: Any suitably qualified Falmouth (initial) + Supervisory Officer.

EQUIPMENT: Liaison Pack.

DUTIES:

- Report to MRCC Centre. Ensure that all relevant information as per tasking form has been passed to Command Support Centre.

- Use direct line 212105
- Monitor and interpret any relevant incoming messages from casualty, support vessels or aircraft and relay them to Command Support Centre.
- Keep a log off messages.
- Liaise with incident, Operations Commanders, Fire Control and Command Support Centre.

Crew Support Officer

His/her role is to assemble, brief, debrief and cater for the firefighting crews. He will liaise directly with the Embarkation Officer and Loadmaster.

RANK: Suitably qualified 3.1 personnel.

SUPPORT: Minimum of 1 assistant

LOCATION: 3.1 Falmouth

DUTIES INCLUDE:

- All firefighting crews must be fully briefed with all available information prior to embarkation from 3.1 Falmouth.
- To control and maintain a log of all personnel on station.
- Supervise the holding, briefing and dressing areas.
- Attend to waiting crews domestic requirements.
- Liaise with Loadmaster to ensure that all necessary equipment is available.
- Process deployed crews ensuring that they are correctly dressed and tallied. This includes issuing of Life Saving equipment.
- Debrief disembarking crews pass information to the Embarkation Officer.

Command Support Officer

Consider all welfare requirements of disembarking crews.

The Officer will be responsible for the supervision and co-ordination of the Command Support Centre at 3.1 Falmouth. He/she will liaise directly with the Embarkation Officer, Crew Support Officer, Loadmaster and the Incident Commander.

RANK: Supervisory Officer

LOCATION: 3.1 Falmouth

Loadmaster

Will be directly responsible to the Crew Support Officer.

RANK: Any suitably qualified 3.1 personnel.

SUPPORT: Assistants as required.

DUTIES TO INCLUDE:

- Ensuring the provision of all safety equipment to embarking crews.
- Supervising the loading of equipment needed for transfer.
- Record all necessary information on the above.
- Supervising the dispatch of equipment and personnel to the appropriate carrier.
- Reposition of all equipment on return to 3.1 Falmouth.
- Recording information on all of the above.

Boarding Officer:-

- To record all personnel boarding the casualty on the "Operations Board". This information will include the name, rank, number, time on board and task allocated.
- To maintain a plan showing the location of firefighting teams, position of jets, etc.
- To ensure personnel detailed to duties working near the water are wearing life jackets and to collect the life jackets of personnel not requiring them once boarded.
- To collect the tallies of personnel boarding the vessel and subsequent relief crews and to return tallies on disembarking.
- To maintain a nominal roll in the event of an evacuation of the vessel and to report to the OC whether all persons are accounted for.
- To make provision for shelter, food, refreshments, first aid and other welfare matters for personnel on board.
- To supervise the transfer of equipment between the vessel and support vessel and to maintain communications between same.
- To assist in monitoring the stability of the vessel and inform the OC of developments.

NOTE The responsibility for a ship's stability falls upon the Ship's Master and his/her officers. In their absence the responsibility may fall on the Operations Commander. In these circumstances the Operations Commander should take advice from the Master of the salvage tug or any assisting vessels and/or the Brigade Stability Officer.

It is most important that the OiC is aware of the length of time personnel have been on board and the amount of work and stress firefighters have been subjected to (BA wearing, etc). The information collated by the Boarding Officer will assist the OiC to look after the health, welfare and safety of personnel under his/her command and assist him/her to maintain good command and control over the incident.

One member of the initial firefighting party (seaborne) will be nominated to carry out the duties of Boarding Officer, which are as follows:-

- To record all personnel boarding the casualty on the "Operations Board". This information will include the name, rank, number, time on board and task allocated.
- To maintain a plan showing the location of firefighting teams, position of jets, etc.
- To ensure personnel detailed to duties working near the water are wearing life jackets and to collect the life jackets of personnel not requiring them once boarded.
- To collect the tallies of personnel boarding the vessel and subsequent relief crews and to return tallies on disembarking.

- To maintain a nominal roll in the event of an evacuation of the vessel and to report to the OC whether all persons are accounted for.
- To make provision for shelter, food, refreshments, first aid and other welfare matters for personnel on board.
- To supervise the transfer of equipment between the vessel and support vessel and to maintain communications between same.
- To assist in monitoring the stability of the vessel and inform the OC of developments.

NOTE The responsibility for a ship's stability falls upon the Ship's Master and his/her officers. In their absence the responsibility may fall on the Operations Commander. In these circumstances the Operations Commander should take advice from the Master of the salvage tug or any assisting vessels and/or the Brigade Stability Officer.

It is most important that the OiC is aware of the length of time personnel have been on board and the amount of work and stress firefighters have been subjected to (BA wearing, etc.). The information collated by the Boarding Officer will assist the OiC to look after the health, welfare and safety of personnel under his/her command and assist him/her to maintain good command and control over the incident.

13. **INSURANCE (Offshore)**

For insurance purposes, not more than 20 Cornwall County Fire Brigade personnel are to be on any one vessel at any one time engaged in operations under this policy.

A member of the Brigade who is engaged in offshore firefighting and rescue is deemed to be "on duty" and, as such, will be covered by the Firemens` Pension Scheme and the additional insurance cover provided by the Fire Authority to protect firefighters in such operations.

Firefighting and rescue at sea will only be carried out by those members of the Brigade who have volunteered for such duties. A list of volunteers will be held at station 3.1 Falmouth and Fire Control.

Members of the Brigade who have taken out private Life or Accident insurance cover should consult their own insurance companies and, where necessary, request them to give an endorsement to the effect that their cover, e.g. accident, life or endowment insurance, will not be prejudiced by injuries or death caused during conveyance by helicopter or seagoing craft.

The insurance companies should be informed that such activities are considered to be part of the normal work of firefighters. Any problems in connection with private insurance should be reported to Brigade Headquarters with full details. Information submitted will be treated as confidential.

Personal Accident Cover - Offshore Firefighting

INSURANCE COMPANY: ZURICH MUNICIPAL

LIMIT OF LIABILITY: The Capital Sum: £303,000

THE ACTIVITIES: The cover is provided for personnel participating in offshore firefighting, waterborne or airborne, and in a maximum of 20 practices a year, all on behalf of the insured.

Maximum of 20 personnel on any one craft at any one time.

COMPENSATION:

Compensation under this scheme is only provided if an individual suffers what is termed a permanent partial disablement or permanent total disablement.

This is to say, if a person sustains broken limbs, cuts, bruises or similar injuries which heal fully in the normal way, no compensation would be payable.

NOTE: This insurance scheme is additional to the normal conditions of service and the **Firefighters` Pension Scheme**. Personnel undertaking such duties will be deemed to be "on duty" and, as such, entitled to the normal benefits.

The scales of entitlement to benefits under this scheme are detailed below.

The policy is based on a capital sum of £303,000 and the percentage of the capital sum payable depends on the nature of the injury - see attached scales of compensation.

For example in the case of a very serious injury such as complete loss of sight in both eyes, the capital sum of £303,000 would be paid in full.

In the case of complete loss of use of a hand, 20% of the capital sum £60,600 would be payable.

The policy provides cover for personnel in the event of injury during the currency of the policy, whilst the persons insured are engaged anywhere in the world in the activities as set out in the Schedule.

SCALE OF COMPENSATION:

Item	Detail	Amount Payable - The following Percentage of the Capital Sum shown in the appropriate Specification	
1.	Death, total and irrecoverable loss of all sight in one or both eyes, total loss by physical severance or complete loss of use of one or both feet at or above the wrist or ankle.	100%	
2.	Permanent total and absolute disablement (other than as stated in Item 1) from engaging in or giving attention to usual profession or occupation.	100%	
3.	Permanent partial disablement (not otherwise provided for above) the percentage of the Capital Sum set against the degree of disablement in the following table:- (a) Total loss of hearing in both ears. (b) Total loss of hearing in one ear. (c) Complete loss of use of hip, knee or ankle. (d) Removal of the lower jaw by surgical operation. (e) Fractured leg or foot with established non-union. (f) Fractured knee-cap with established non-union. (g) Shortening of a leg by at least 3 cms (h) Loss by amputation or complete loss of use of:- (i) One thumb. (ii) One index finger. (iii) Any other finger. (iv) One big toe. (v) Any other toe. (l) Complete loss of use of shoulder or elbow. (j) Complete loss of use of wrist.	40% 10% 20% 30% 25% 20% 15% Right 20% 15% 10% 10% 3% 25% 20%	Left 17.5% 12.5% 7.5% 10% 3% 20% 15%
4.	Permanent facial disfigurement to an extent of not less than 5 cms ² of scar tissue in the area from the hairline to and including the lower jaw and ears.	10%	
5.	Loss of or damage to teeth and dentures - the cost of dental treatment or replacement of dentures up to a maximum.	2.5%	

MEMORANDUM TO THE SCALE OF COMPENSATION:

1. Applicable to Item No. 2:

If, after expiry of 52 weeks consecutive disablement, the Insured is still totally disabled from engaging in or giving attention to usual profession or occupation but the medical evidence is such that it cannot be said that such disablement is permanent, total and absolute, payments will be made for as long as such total disablement continues for a period not exceeding 10 years. Such payments shall be at an annual rate of 10% of the benefit provided under Item 2 and will be by half-yearly instalments in arrears. The first of such payments shall be made 18 months after commencement of disablement in respect of the first 18 months of such disablement.

2. Applicable to Item No. 3.

(a) In the case of other permanent partial disablement not specified in Item 3, the amount payable shall be such proportion of the Capital Sum as is commensurate with the

degree of permanent, partial disablement when compared with the degree of disablement specified in Item 3.

(b) The benefits under (h), (l) and (j) shall be reversed in the case of a left-handed person.

3. The total amount payable under Items 1 to 5 for all accidents sustained in any one period of Insurance by any one person insured shall not exceed the Capital Sum specified in the appropriate specification.

MEMORANDUM:

If after the expiry of 52 weeks consecutive disablement the insured person is still totally disabled from engaging in or giving attention to any profession or occupation of any kind but the medical evidence is such that it cannot be said that such disablement is permanent total and absolute, payments will be made for as long as such total disablement continues for a period not exceeding 10 years. Such payments shall be at an annual rate of 10% of the benefit provided under Item 1, and will be by half-yearly instalments in arrears. The first of such payments will be made 18 months after commencement of disablement.

14. EQUIPMENT LOADS

	Contents	Weight	Location
VALISE NO. 1 (Strike Team)	2 BA - 1 with communications c/w cylinders	43kg	BC
	1 BA Control Board complete	5kg	SK
	1 Thermal Imaging Camera	8kg	SK
	1 Box spare batteries and Allen keys	5kg	SK
	3 Torches (Wolflite)	3kg	SK
	2 Hose - 45mm x 15M	18kg	SK
	2 Radio Pack Sets and waterproof covers	1kg	WrT
	1 Bulkhead Thermometer	1kg	SK
	1 Wheel Valve Spanner	1kg	SK
	2 BA Cylinders	7.8kg	
	1 Command Wallet (Ops Commander)	2kg	
	Spare Radio Batteries	1kg	
	TOTAL WEIGHT:		95.8kg
VALISE NO. 2 (Strike Team)	2 BA sets complete with cylinders	42kg	WrT
	1 Guide Line	2kg	SK
	1 30M Line	6kg	SK
	2 Hose 45mm x 15M	18kg	SK
	3 Torches (Wolflite)	3kg	SK
	1 Large Axe	3kg	SK
	1 Branch (Elkhart)	3kg	SK
	1 First Aid Box	1kg	SK
	1 Boarding Control Board	3kg	CC
	1 In line shut off valve	3.3kg	BASU
	1 Transfer Line	3kg	
	1 1 Full ?? Device	8kg	End Bay
	1 Mini-ops ???	2kg	
	1 Command Wallet	2kg	
TOTAL WEIGHT:		99.3kg	

	Contents		Weight	Location
VALISE NO. 3 (Strike Team)	2	BA Sets complete with cylinders	42kg	WrT
	4	Spare BA cylinders	59kg	WrT
	2	45mm x 25M Hose	18kg	SK
	1	3 Way Dividing Breeching	4kg	WrL
	4	Torches (Wolflite)	7kg	SK
	1	Small First Aid Kit		
	TOTAL WEIGHT:		130kg	
VALISE NO. 4	2	BA sets complete with cylinders	42kg	WrL
	4	Spare BA cylinders	57kg	WrL
	2	45mm Hose	18kg	HS
	2	Branches (Elkhart)	5kg	SK
	1	15M Line	3kg	SK
	4	Torches (Wolflite)	4kg	SK
	2	In Line Shut Off Valves	6.6kg	
TOTAL WEIGHT:		135.6kg		
VALISE NO. 5	1	BA Service Kit	3kg	SK
	1	Stability Board	4kg	SK
	1	Ship`s Log	1kg	SK
	1	Guide Line	2kg	SK
	4	Cylinders	59kg	BC
	1	Shifter Wrench	1kg	SK
	2	Boxes Hot Cans and spoons/wipes in box	22kg	SK
	1	Box rags	12kg	SK
	10	Spare Overalls	10kg	SK
	10	PVC coats	12kg	SK
TOTALWEIGHT:		126kg		
VALISE NO. 6	1	BA Service Kit	59kg	BC
	2	Large Axes	5kg	SK
	1	15M Line	3kg	SK
	1	30M Line	6kg	SK
		Gloves	12kg	SK
	4	Cans fresh water	23kg	SK
	4	Branches	8kg	SK
	2	Empty Valises (green)	4kg	SK
	3	Torches (Wolflite)	3kg	SK
	1	Snatch Block	4kg	BC
	1	Wrecking Bar	4kg	SK
TOTAL WEIGHT:		131kg		

MARINE OPERATIONS ~ The Use of Helicopters For Offshore Operations.

Summary:-

Based on an agreement reached between United Kingdom SAR organisations and participating coastal Fire Services, this document indicates Best Practice in the role of mobilising CCFB resources via helicopter to incidents on vessels at sea.

Further Information:-

MOU between MCA and the Fire Service.

DCOL 9/92

BIS docs. - Marine Operations ~ Safe Working on or near Water

- Marine Operations ~ Ship Firefighting **February 2001**

Contents	Page
<u>KEY INFORMATION:-</u>	
STRATEGIC ASSESSMENT	2
INITIAL MOBILISATION	3
OPERATIONAL COMMANDER - AIDE MEMOIR	
SAR Response to Ship Fire with Cornwall County Fire Brigade	4 5
PRIMARY INFORMATION:-	
1. INTRODUCTION	
2. COMMAND AND CONTROL	5
3. RESPONSE CRITERIA	5
4. TEAMS	5
5. EMBARKATION	5
6. EQUIPMENT / COMMUNICATIONS	8
7. HELICOPTER LOADS, DISTRIBUTION AND SEATING	9
8. PERSONAL EQUIPMENT	9
9. WELFARE OF PERSONNEL	10
10. CLOTHING	10
11. TRAINING FOR HELICOPTER OPERATIONS.	11
SUPPORTING INFORMATION:-	
12. TERMS OF REFERENCE	
13. CRITERIA FOR RESPONSE	
14. MUTUAL ASSISTANCE	13
15. COMBINED TRAINING AND LIAISON	13
16. TASKING FORM	14
17. NOMINAL ROLL FORM	14
18. OPERATIONAL EQUIPMENT	15
19. EQUIPMENT WEIGHTS	16
20 AIRCRAFT TYPE / LAYOUT	17
21 GLOSSARY	18
	19
	22

KEY INFORMATION - SHEET ONE

STRATEGIC ASSESSMENT

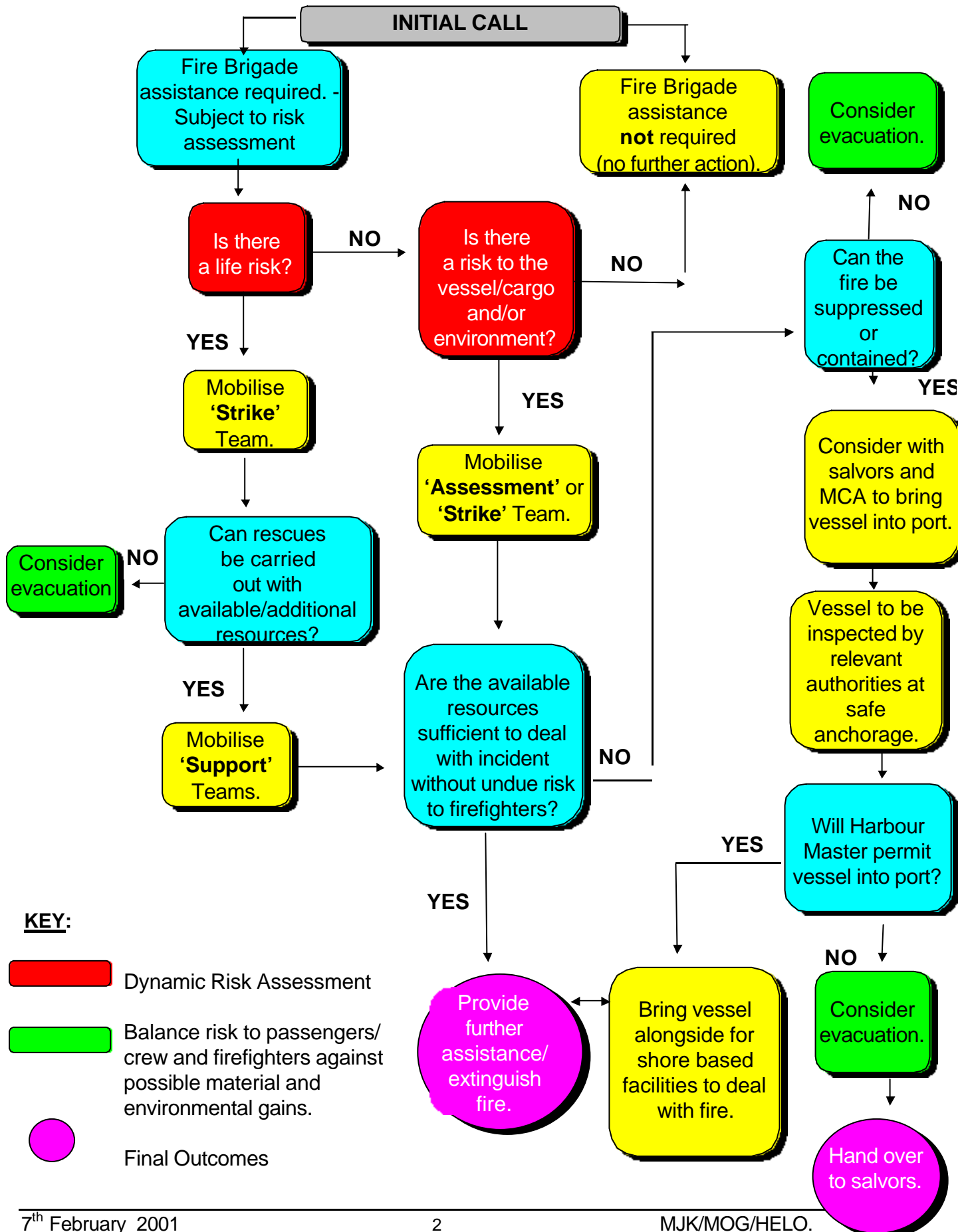

KEY INFORMATION - SHEET TWO

Initial Mobilisation

THE FOLLOWING MUST BE COMPLETED:

INITIAL COMMAND MEASURES.....

OBTAIN FULL DETAILS VIA TASKING FORM (*See Appendix 1*)

ALERT APPROPRIATE RESPONSE TEAMS
(*See Key Information - Sheet 1*)

ADVISE NEAREST PARTICIPATING BRIGADES -
(*Mutual Assistance, see Section 14*)

DESPATCH OFFICER TO LOCAL MCA CENTRE FOR LIAISON

ENSURE EMBARKATION OFFICER IS APPOINTED

TEAM TO SAR RV - ADVISE MCA

DEPLOYMENT PROCEDURES...

TEAM HELO.SAFETY BRIEF AND INCIDENT UP-DATE

ENSURE NOMINAL ROLL COMPLETED (*See Appendix 2*)
Shut down all handheld comms. for transfer.

'Strike / Support' teams only - CONFIRM WEIGHTS WITH SAR WINCH OPERATOR

SENIOR FIRE OFFICER e.g OPERATIONS COMMANDER (OC) TO COMMUNICATE WITH PILOT AND SITS NEAR DOOR

OVERFLY VESSEL FOR RISK ASSESSMENT (RA) (*Assessment / Strike teams only*)

- NOT SAFE TO BOARD - RETURN TO RV
- SAFE TO BOARD - 'OC' OR WINCH MAN TO DECK
- FIRE No.2 (*Command Support*) TO DECK

FURTHER RA AND CONFIRMATION THAT FIRE BRIGADE ASSISTANCE IS REQUIRED FROM MASTER

EQUIPMENT TO VESSEL

REMAINING TEAM MEMBERS TO VESSEL

PROVIDE SITREP TO MCA

ACTIONED
(Tick)

KEY INFORMATION - SHEET THREE

'OPERATIONAL COMMANDER' AIDE MEMOIR

YOU ARE NOW ON BOARD THE CASUALTY:

ADVISE MCA OF ARRIVAL AND NUMBERS ONBOARD - INSTIGATE
'BOARDING' AND COMMAND SUPPORT PROCEDURES

LIASE WITH SHIP'S MASTER

ESTABLISH AN EVACUATION / ABANDON SHIP MUSTER POINT AND
PROCEDURE. BRIEF FIRE TEAM.

ESTABLISH A INCIDENT COMMAND POINT - *normally ship's BRIDGE*

CHECK COMMUNICATIONS LINKS WITH MCA

SURVEY INCIDENT - CREWS MUST NOT WORK ALONE

CONFIRM STAND-BY VESSEL / SAR AVAILABLE FOR EGRESS

CHECK FIXED INSTALLATIONS AVAILABILITY

CONSIDER LOCATION OF SECTOR COMMAND POINT

DYNAMIC RISK ASSESSMENT RE-EVALUATION. ADVISE IC.

MAXIMISE USE OF SHIP'S PERSONNEL - GUIDES ETC.

PREPARE FOR '*Strike*' / '*Support*' TEAMS IF 'OFFENSIVE' TACTICS BEING
CONSIDERED

BA TEAMS TO BE MINIMUM OF THREE

ESTABLISH REST AND RECOVERY AREA NEAR EVACUATION / ABANDON
SHIP MUSTER POINT IF POSSIBLE

MAINTAIN 20 MINUTE BRIEFINGS (INCLUDING ROLL CALLS) WITH ALL
PERSONNEL / MCA / FIRE SERVICE CONTROL OR LIASION OFFICER AT
MRC / MRCC

ACTIONED
(TICK)

KEY INFORMATION - SHEET FOUR

S.A.R Response to Ship on Fire with Cornwall County Fire Brigade

Although the primary use as indicated is for vessels on fire at sea and does not include reference to none SAR helicopter operations e.g police helicopters, some of the practices identified may be suitable for other areas of Fire Service operations.

2. COMMAND AND CONTROL

Command and Control for these incidents is based on the principals of the Incident Command System (ICS) as defined in the Fire Service Manual - Volume 2 - Incident Command.(Published 1999)

In that respect the Incident Commander (IC) is in overall charge of the incident and will remain ashore at the local MRC/MRCC The Operational Commander (OC) will be dispatched to the casualty with his / her 'Command Support' .

These Command Team Officer's will be identified by the appropriate tabards, which also display the relevant role.

3. RESPONSE CRITERIA

- Request from MCA for assistance.
- Request from another source that is approved and supported by the MCA.
- Approved by Fire Brigade Principal Officer - where there is an immediate risk to life or high risk of an incident developing that will have a serious environmental impact.

HELICOPTER 'STRIKE' TEAMS ACTING IN ISOLATION WITH LIMITED RESOURCES SHOULD NOT INITIATE 'OFFENSIVE' TACTICS. HOWEVER, FOLLOWING A DYNAMIC RISK ASSESSMENT (DRA) THE OPERATIONS COMMANDER MAY INITIATE LIMITED ACTIONS e.g SNATCH RESCUES

The defined task will be to provide actions and make provisions for when additional resources become available.

4. TEAMS :-

'ASSESSMENT' TEAM

When appropriate, e.g. only limited information is available, no immediate risk to life - an assessment team may be initially dispatched to carry out risk assessment before committing additional resources.

Composition

- Minimum of two Officers with the relevant competencies...the 'assessment' team may form part of a larger 'multi agency' response
- The team should wear full PPE i.e immersion suit and lifejacket and carry a minimum of equipment as follows:-
 - Welfare packs (2kgs)
 - Marine band radios.. two (1kg)
 - Heavy duty torch (1 kg)
 - Thermal Image camera (8kg)
 - Command Wallet / Notebooks / Dictaphone(2kg)

Purpose

- To provide professional advice on matters relating to fire.
- Provide first impression information.
- Transmit a full situation report via Coastguard coordinating station.
- To provide the Fire Brigade Principal Officer with risk assessment information to enable decision on further deployment to be made at the strategic level.

'STRIKE' TEAM:

Normally mobilised when full information is available and / or immediate threat to life on the casualty

NOTE:-

Any subsequent teams can only be 'Support' team(s) who's composition must be determined by the OC in liaison with the IC (shorebased), taking into account the balance of need i.e personnel or equipment.

Composition

Minimum team of six, with pre designated equipment bags - One - Two - Three (*see Sections 6 and Appendix 3*).

Minimum of two Officers with relevant competencies if no 'Assessment' team previously mobilised.

This will provide an Operations Commander and / Command Support.

The final decision for deployment of personnel to the casualty will rest with the OC in consultation with the pilot of the aircraft.

The 'Strike' team consists of only Fire Service personnel

Purpose

- Carry out a risk assessment (as per the 'Assessment' team if not previously deployed).
- Collect information - *see KEY INFORMATION sheets*
- Transmit a full situation report via the coordinating MCA.
- Make provision for: Command and Control, Safety, Welfare and Communications.
- To provide the Fire Brigade Principal Officer with a risk assessment to enable decision on further deployment to be made at the strategic level.
- Request necessary resources to enable the incident to be dealt with effectively. The resources requested should be prioritised to enable proper logistical planning by onshore organisation.

'SUPPORT' TEAM(S)

When all assessments have been concluded the OC may take the decision that some 'Offensive' tactics are necessary. Support teams will need to be mobilized to ensure these actions can be carried out with maximum safety and appropriate resource support.

Further resources may be committed via a seaborne transfer.

'Support teams' may be mobilised from other participating Brigades.

The OC must ensure that suitable, safe means of egress are available from the casualty for all those persons who will eventually be onboard. This may include the use of helo, standby vessels or the casualties own evacuation equipment.

Ultimately the number of personnel onboard the casualty will be down to local agreements.

Composition

At the discretion of the OC in liaison with the IC (shorebased), taking into account the balance of need i.e personnel or equipment.

Account must be taken of helo carrying capacity. Maximum payload of 2500lbs/ 1125kgs.(See Appendix 5 re aircraft 'types' and configuration)

Purpose

- to support 'Strike' team
- to carry out tactical firefighting and rescues as determined by the OC

5. EMBARKATION

In all circumstances a nominal roll form (Appendix 2) should be completed to record all personnel taken offshore. Copies of this should be FAXED to HM Coastguard, HM Customs and the HM Immigration Office which covers the Service/Brigade where the incident has occurred. With HM Coastguard being the central coordinator in cases of repatriation, if this becomes necessary.

In the case of firefighters returning to shore, their Fire Control Centers must fax their names to HM Coastguard to ensure nominal rolls are always current.

Prior to departure / embarkation all crews must have received a pre flight safety brief. This must include details on the aircraft to be used, appropriate use of PPE .e.g. eye, ear protection, methods of approach, seating and equipment location, disembarkation and emergency procedures.

The pilot may require illumination of the landing zone when collecting or returning crews, this may be done by the use of two fire appliance's headlights directed in a vee shape on the landing zone. Night vision goggles may be used by the aircrew in these circumstances, strong torches etc should never be shone directly at the aircraft.

NB. The Coastguard may be mobilised to secure the landing site.

6. EQUIPMENT / COMMUNICATIONS

The teams, personnel and equipment should meet the following:

- Current standards for the safety and protection of personnel during transportation, transfer and activities on board vessels in need of assistance.
- Current standards for the safety and protection of personnel during firefighting and associated activities.
- Enable personnel to communicate to the relevant rescue co-ordination centre.
- To ensure agreement on commonality of specified equipment, load bags will be identified and contain equipment as shown in Appendix 3.
- Approved loading bags must be used that meet the following criteria:-

Maximum dimensions.....
Sling heights.....
Base specification....
Method of clearly displaying contents.
Identify safe working load (SWL), and be tested and recorded.
(Suggested specification for load bags is shown in Appendix 6)

All portable radio equipment including cellphones, taken on board a helicopter must be switched OFF and must not be operated inside the helicopter.

Radio communications for the Fire Service Crew whilst on board the helicopter will be provided by the helicopter crew.

Communications with the aircraft will only normally be available via VHF Marine wave band radio's. Crews operating on the ground, without assistance from a member of the aircraft's crew, should always maintain communications with the helicopter.

7. HELICOPTER LOADS, DISTRIBUTION AND SEATING

Maximum loads may differ for different types of helicopter. In all cases the maximum load will be at the direction of the helicopter loadmaster or pilot.

Loads must be secured within the aircraft by the aircraft 'loadmaster'.

Fire Services should have available prepared equipment lists with weights in lbs/kgs to cover all the equipment likely to be utilised. Weight calculation charts should also be incorporated and account must be taking of Manual Handling regulations.

Appendix 3 details equipment loads for 'Strike' team. Further specific loads for 'Support' teams will depend on the nature of the incident. However, it is anticipated that equipment dumps will be prepared at helicopter landing sites.

The distribution of loads and seating of personnel is the responsibility of the pilot. Suggested seating plans are shown in Appendix 5.

The seating arrangements should be such that the Fire Service Commander is able to:

- Carry out visual reconnaissance...
- Egress the aircraft to the deck of the casualty first...
- Link to the aircraft communications systems.

NB.

Equipment carried by waterborne response may be subject to helo transfer and therefore should comply with the above criteria.

8. RECOMMENDED STANDARDS OF PERSONAL EQUIPMENT

Lifejacket

Lifejackets must be approved to meet the current standards required by military and CAA for airborne use.

NB.

Local procedures should be in place with the 'carrier' to ensure lifejackets cannot auto inflate during transit

Immersion / Transit Suits

Immersion / Transit suits must be approved to meet the current standards required by military and CAA for airborne use.

Immersion / transit suits for helicopter use are the minimum requirement for travelling by helicopter and are to be worn at all times during transportation.

Head Protection

A Fire Brigade helmet with chin strap fastening and built in visor is the minimum standard.

Ear Protection

Appropriate ear protection should be made available to all personnel prior to embarkation, and guidance given on their use.

Ancillary Equipment

All personnel should be afforded the appropriate level of personal protection and safety equipment which may include:

- The provision of a supplementary air device.
- Safety belt with pouch, personal line and karabiner.
- Cylume chemical lights.(to be worn at night on board vessel)
- Torch.

9. WELFARE OF PERSONNEL

To be able to provide personnel with such equipment as they need to sustain them for a reasonable period of time offshore, should arrangements not be available on board the vessel or standby vessel(s), welfare packs should be provided.

The exact nature of welfare packs is not stipulated, however, the following should be considered:

- Hot packs
- Drinking Water
- High Energy Bars
- Toilet Paper
- Face Wipes
- Hand Cleaner
- Sea Sickness pills / Seabands

Personnel who require to take seasickness tablets (subject to advice from Brigade Occupational Health) must ensure these are taken before embarkation (some tablets may cause drowsiness and this needs to be taken into account). Sea wrist bands provide some protection from seasickness and may be considered an alternative to seasick tablets.

All personal equipment and food could, if required, be carried in a personal holdall which the individual could retain during the flight and winching operation
This equipment must be limited in weight to the extent that it will not increase equipment levels beyond the maximum weight limits allowed for helicopter transport

Consideration must also be given to immigration provision, where firefighters may land in a foreign country and may have welfare needs prior to repatriation. (See also Section 5)

10. CLOTHING

If personnel are committed to a fire or Hazmat situation of any significant size it would be desirable to provide them with a complete change of clothing as their own may have become wet through penetration of water or excessive sweating. The clothing must be compact, windproof and easily carried but must provide warmth and comfort to the wearer.

Consider the following:-

- Thermal Underwear
- Overalls/One Piece Suit
- Socks

11. TRAINING FOR HELO OPERATIONS.

Training for operations needs to be developed via local training needs analysis. However in consultation with MCA and CAA the following should be considered:

GROUND TRAINING

- brief on aircraft statistics
- approaching the aircraft, hazards e.g 'downwash', debris, PPE
- boarding aircraft to include identification of Fire Commander (OC),
- seating plan and moving around the aircraft
- communication
- preparation to winch
- winch procedure - including 'high line'
- loading and storage of Fire Brigade equipment
- indication of ditching/crash procedures
- bracing position
- post impact procedure
- emergency exits
- escape procedure

AIR (FLYING) TRAINING

- take off and landing procedures
- winching from and to the aircraft ~ crew and equipment including 'high line'
- communication with aircraft including ground to air signals

SEA SURVIVAL TRAINING

Brigades carry out sea survival training to maintain the relevant competencies and this includes the use of:

- lifejackets
- immersion suits
- life rafts
- lifting from the water

ADDITIONAL TRAINING PROVIDED MAY INCLUDE:

- Welfare e. g use of ear defenders, anti nausea provisions, etc
- wet winching drills, i.e. whilst wearing full PPE will be recovered by helicopter from the water by winch after exiting life raft.

SUPPORTING INFORMATION

12. CACFOA 'OFFSHORE FIREFIGHTING NETWORKING GROUP' - TERMS OF REFERENCE

On behalf of offshore firefighting practitioners, to draw together offshore incident procedures including training and equipment.

To liaise with the MCA who are the overall coordinating authority, Royal Navy and Royal Air Force Search and Rescue regarding the appropriate 'at sea' response.

Specific areas considered by the working group included:

- Criteria for authorisation and alerting Fire Services responses.
- Minimum training.
- Composition of offshore teams.
- Standard list of operational equipment to meet the needs of the respective roles of the above teams.
- Minimum standards of PPE
- Response and assembly times
- Mutual assistance between the participating Fire Services
- Welfare of personnel
- Combined training and liaison arrangements

13. CRITERIA FOR RESPONSE

The MCA will seek the help of the CCFB after receiving a request for Fire Brigade assistance from the Master of a vessel at sea. It is considered that the Brigade may respond to calls for assistance particularly where life is at risk. The decision to attend or not will be made by the Chief Fire Officer or his/her nominated representative.

The Brigade has declared availability to MCA. Any changes to 'declared assets' will be communicated to MCA immediately

The Chief Fire Officer and his/her representative will require specific information before committing the resources of the Brigade. The form detailed in Appendix One should be used for this purpose. In the first instance HM Coastguard should attempt to complete those items asterisked and in bold print. This should also be faxed to the Fire Control by the coordinating HM Coastguard station. Subsequent information can be added when required by the Coastguard.

Although the helicopter approach to a vessel in difficulty is by far the fastest response, it cannot be guaranteed that the helicopter can remain on scene indefinitely, however it will remain "on station" over the casualty vessel after disembarking the fire team(s) until a vessel is alongside to provide safe egress for the party.

The OC must maintain communications with the pilot via "Falmouth Whiskey". Should seaborne transport not be immediately available on the scene, the OC should request of the pilot that a relief helicopter be provided and maintained on stand-by until seaborne support arrives

To ensure the safety of firefighters on board a casualty vessel that is either on fire or disabled, firefighters should not be allowed on board a casualty vessel unless a satisfactory risk assessment has been completed..and suitable egress is available. Suitable means of egress to include:Helicopter, RNLI lifeboat and ships life saving equipment, tug, rig support vessel or similar is on scene or in contact with the Coastguards and en route to the incident. If no line of safe retreat is to be identified by the RA, then boarding of vessel will not occur.

In order to provide early notification to neighboring Fire Services of an incident at sea, the Brigade attending such an incident would take steps to notify participating Fire Services as soon as possible after the initial call. Arrangements should also be set up to notify adjacent Fire Services of relevant "Informative and Stop Messages".

In the event of the MCA being unable to agree the attendance of the CCFB to an incident at sea they would obviously attempt to obtain the services of an adjacent Fire Service (second Fire Service). In such circumstances the second Fire Service should contact CCFB to establish why they had declined to make an attendance.

14. MUTUAL ASSISTANCE

Intention of Mutual Assistance: There is a general agreement between participating Fire Services that when requested, they will supplement each other resources. This agreement is intended to cover eventualities when the demands of an incident at sea exceed the resources of the first Fire Service.

Application: the Principal Officer of the host Brigade will advise neighboring Brigades that participate in the mutual assistance agreement, of the host Brigades intentions so resources can be made available at the earliest opportunity to reinforce. The MCA must also be advised as the requirement for helicopter transfer between Brigades will be required.

Before any attempts are made to react to a request for mutual assistance, the host Fire Service must seek the agreement of the respective Fire Brigade Principal Officer(s).

15. COMBINED TRAINING AND LIAISON

All Fire Brigades participating in offshore incidents that involve the use of helicopters as a primary mode of transport should carry out training with the appropriate 'carrier' and also with other key agencies e.g MCA and 'mutual assistance Brigades

Training should include testing of command and control procedures, mobilising procedures, communication functions and the ability to respond to a request for mutual aid. Brigades must ensure that when mutual aid training is carried out, personnel are made aware of any relevant differences in practices and procedures.

16. MCA TASKING FORM

THIS FORM SHOULD BE HELD AND COMPLETED BY THE LOCAL MRC/MRCC

INFORMATION REQUIRED FROM MCA (Initially that information in bold and asterisked MUST BE SENT). DO NOT DELAY IF INFORMATION IS INCOMPLETE.

FAX TO FIRE BRIGADE : 01872 274440					TIME:-		
1. MCA CO-ORDINATING RESCUE CENTRE							
2. NATURE OF EMERGENCY AND COMPARTMENT INVOLVED*							
3. POSITION OF VESSEL - COURSE*							
4. VESSEL NAME*					DWT/GT*		
5. TYPE OF VESSEL *		6. TOTAL NUMBER OF PERSONS ABOARD*			CREW*	PASSENGERS*	
Owner/Agent:		Are Persons Trapped or Missing Aboard*			Yes	No	
Nature of Cargo*:		Nationality of Master/Crew:					
Interpreter Required					Yes	No	
7. Hazards that could affect Fire Brigade operations				8. WIND/SEA STATE AND AREA FORECAST*			
9. Ship's Fire		Capacity Tons/	10. Fixed Fire		Yes		No
Pumps Operative		Hour	Installations. Has it been Operated?				
Yes	No		Type	CO2	Halon	Sprinkler	Others Specify
11. Communications facilities on board vessel:			Yes	No	12. Stability problems:		
13. HELICOPTERS AVAILABLE*		SEA KING (RN/MCA)		SEA KING RAF	SIKORSKY		
Lift Capability at Time of Tasking:		<input type="checkbox"/>	<input type="checkbox"/>	<input type="checkbox"/>	<input type="checkbox"/>		<input type="checkbox"/>
Landing Site for Helicopters:							
14. Vessels Available for Transportation:		Name			Type		
Loading Point:							
Other Vessels going to Assist:							
Additional Information							



18. OPERATIONAL EQUIPMENT

The following are standardised minimum loads :

BAG 1 ~ 'STRIKE TEAM'

	KGS	LBS
2BA - 1 with Comms c/w Cylinders	27.5	60.3
1 BA Control Board Complete	5.0	11.25
1 Thermal Image Camera	8.0	18.00
1 small pelican case of spare batteries, Alan Keys and BA Service kit	5.5	12.00
3 Torches (Wolflite)	2.0	4.4
2 Hose - 45mm x 15m	17.8	40
Spare radio batteries	0.5	1.2
9 Bulkhead Thermometer	4.5	9.9
1 wheel valve spanner	1.0	2.2
2 BA spare cylinders	7.8	17.5
Fall Arrest device	2.0	4.4
Command Wallet (sector command)		
	Total	

RADIOS WILL BE CARRIED IN INDIVIDUAL VALISES

BAG 2 ~ 'STRIKE TEAM'

	KGs	LBS
2 BA sets c/w cylinders	27.4	60.28
1 30m line	6.0	13.5
2 hose 45mm x 15m	17.5	40.00
3 torches (Wolflites)	2.0	4.4
1 large axe	3.0	6.7
1 branch (Elkhart)	2.5	5.6
1 First Aid Box	5.8	12.7
1 Boarding Control Board	6.0	13.2
1 in line shut off valve	3.3	6.6
2 BA spare cylinders	7.8	17.5
1 Transfer line	3.0	6.6
Mini gas XL gas monitor	2.0	4.4
Command Wallet (ops command)	2.0	4.4
	Totals	

The Brigade need to be aware that the OC may request additional operational equipment via 'Support teams' and that due to its weight will have an implication on helo loads.

Therefore their is available prepared equipment lists with weights in Kgs/lbs to cover that equipment likely to be utilised for offshore operations.

19. EQUIPMENT WEIGHT CHART(Example)

Any further equipment required by the Offshore team, will be identified following the Operational Commander's tactical risk assessment. (This detail must be available for other participating Brigades and carriers should it be so required).

Examples as follows:-

Contents		Kilo's	Pounds
1	BAG AND BOX (optional	10	22
2	45mm x 25M Hose	18	40
1	3 Way Dividing Breeching	4	9
4	Torches - Heavy duty	7	15
2	CABA SETS complete	30	67
2	Branches (Elkhart)	5	8
1	15M Line	3	7
1	BA Service Kit	3	7
1	Stability Board	4	4
1	Ship's Log	1	2
1	Guide Line	2	5
1	Shifter Wrench	1	2
2	Welfare pack e.g Hot Cans etc	22	46
1	Box rags	12	26
10	Spare Overalls	10	22
10	PVC coats	12	26
2	Large Axes	5	8
1	30M Line	6	14
4	Cans fresh water		
4	Branches - 'Fogfighter'		
1	Snatch Block		
1	Wrecking Bar		
1	Fall Arrest Device / Body harness		
1	Ship / Shore couplings		
1	Cellar nozzle		
1	PPV Fan		

Account must be taken of available aircraft payloads and manual handling restrictions.

20 AIRCRAFT TYPE AND LAYOUT (3)

SEA KING (RAF)

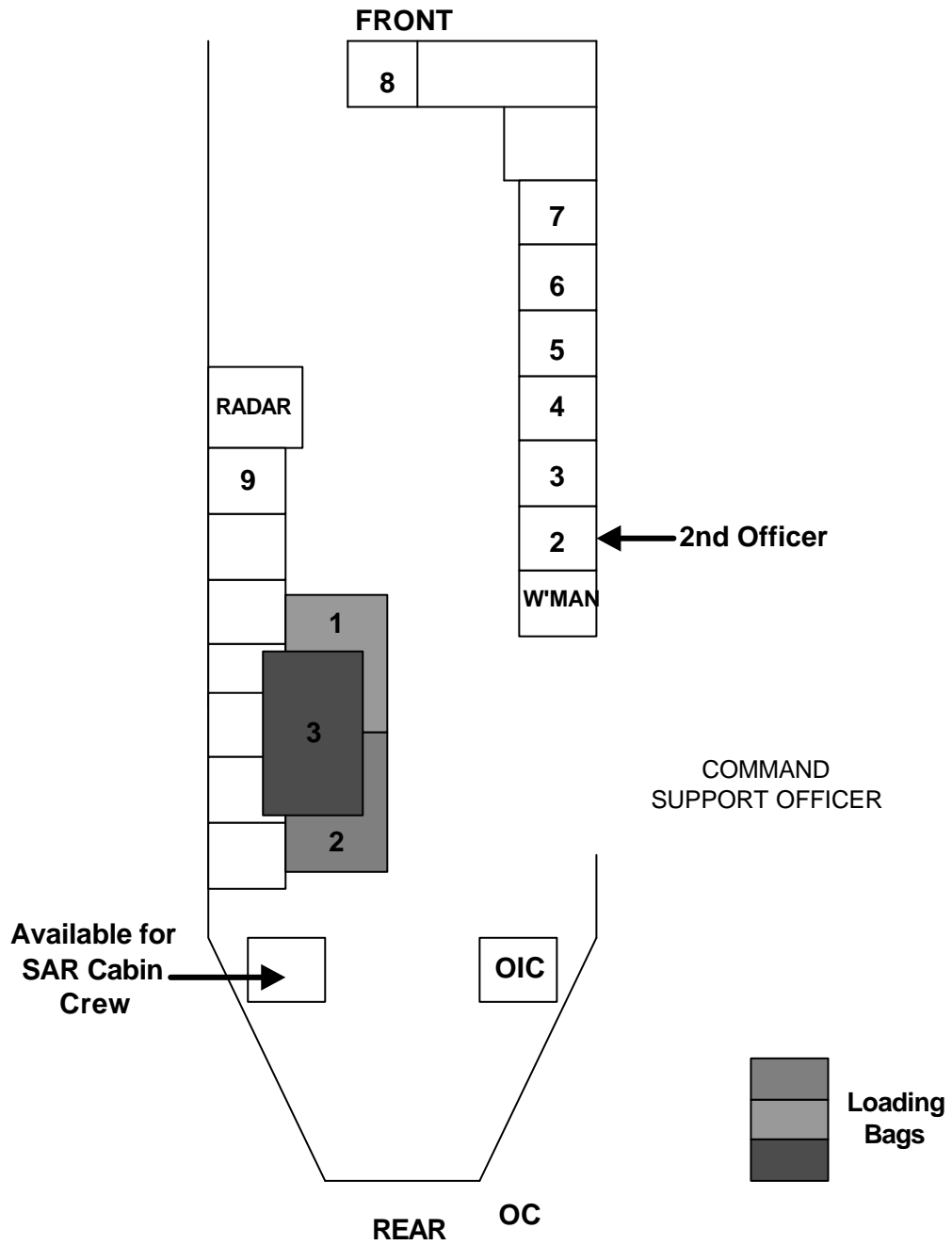

SIKORSKY S61 (MCA)

FRONT

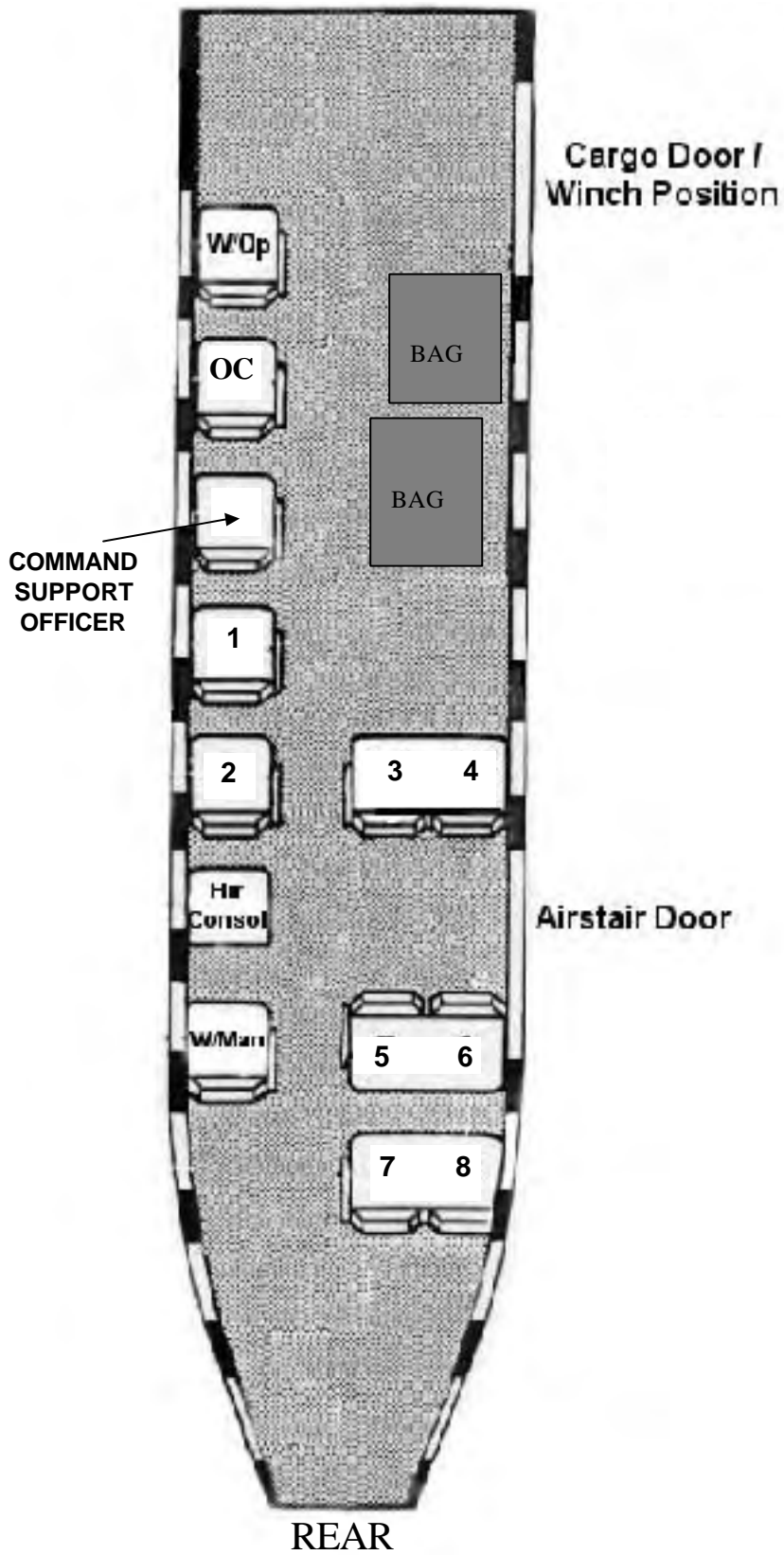

SEA KING MK 5 (RN)

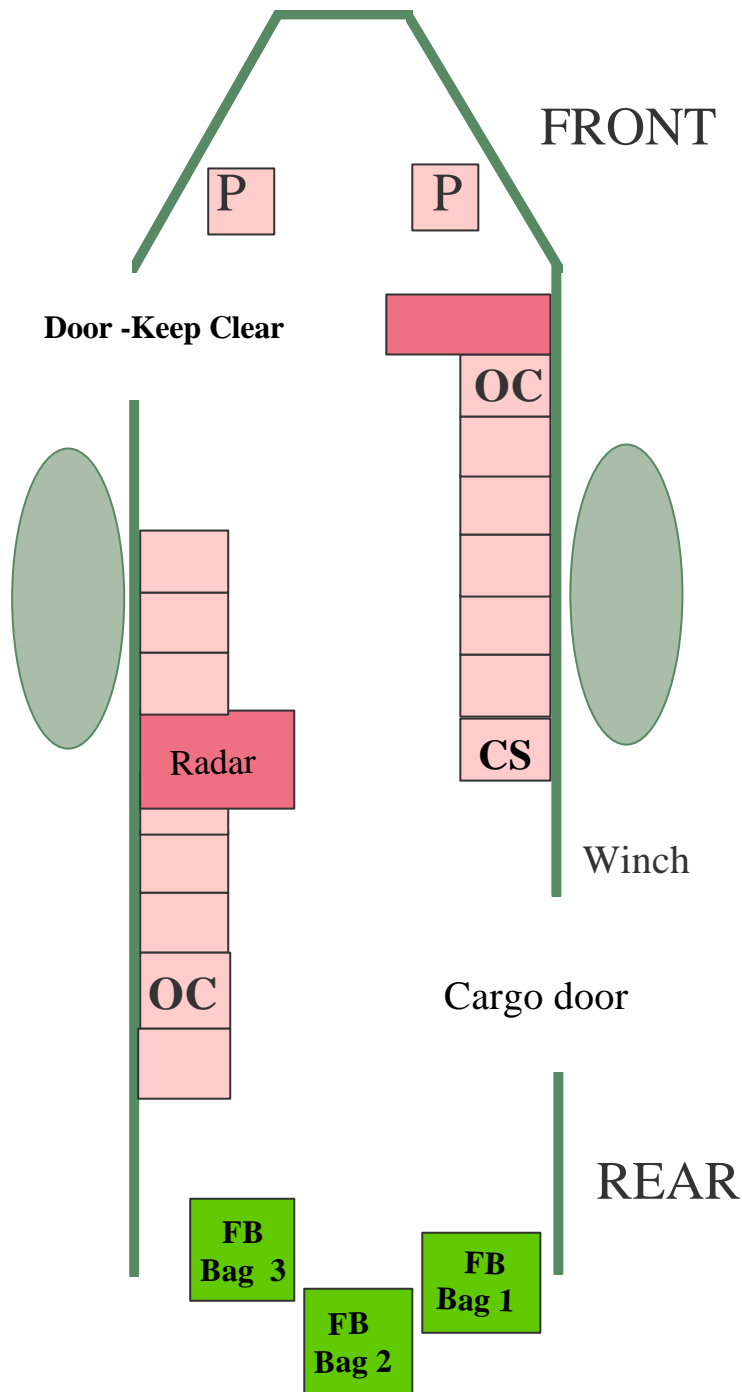

(The Fire Brigade Operations Commander may be seated in either of the seats shown OC as determined by pilot. (The OC will be provided with a headset for communications.)

CS ~ Command Support Officer.

21. Glossary of terms

BABreathing Apparatus_

CACFOA.....Chief and Assistant Chief Fire Officers Association.

CASUALTY....MCA terminology indicates that this is a stricken vessel (the vessel in trouble).

CARRIER....The SAR organisation providing transportation i.e RN; RAF; MCA

COMMAND SUPPORTA Fire Brigade Officer nominated to assist the OC.

DECLARED RESPONSE....A statement of Fire Service resources currently made available to MCA.

EVACUATION SIGNAL ...the Fire Brigade emergency evacuation signal is repeated blasts on an 'Acme Thunderer' whistle.

EMBARKATION OFFICER...A Fire Brigade Officer nominated to monitor embarkation details of personnel and equipment being conveyed offshore

INCIDENT COMMANDER (FIRE)....Senior Fire Brigade officer (*shorebased*) in overall command of the incident

MCA...Maritime and Coastguard Agency (inc. Coastguard)

MRC....Maritime Rescue Centre

MRCC...Maritime Rescue Coordination Centre

OPERATIONS COMMANDER (OC)....The Senior Fire Brigade Officer onboard the casualty.

RESCUE CO-ORDINATION CENTRE (RCC)....Air operations coordinated from RAF Kinloss,

SAR FACILITY....Any unit, command, device or system used for SAR operations

SEARCH AND RESCUE (SAR)....The employment of available personnel and facilities in rendering aid to persons in distress.

SOSREP... Secretary of State's Representative

Divisional Officer Mervyn Kettle Cornwall County Fire Brigade



- Case History - The 'Scandinavian Star'



Executive summary...

On the 7th April 1990 the
Roll-on Roll-off passenger ferry
'Scandinavian Star'
was on passage from Norway to Denmark.
Onboard were 383 passengers and 99 crew.
A major fire took place that ultimately
claimed the lives of 158.

The ship...

- Built in 1971...
- Registered to 'Seascope' in the Bahamas...
- Stern ramp only...
- Length 141m; Beam 22m...
- Nine decks...

Fire safety....



- 12 transverse watertight bulkheads...
- 4 fire pumps...
- Sprinkler system on car deck three...
- Hydrants / extinguishers...
- Automatic Fire Detection (AFD) in machinery spaces and some stores only...
- Manual fire alarm - 148 call points / 53 sounders...

and

- Escape lighting (by fire doors only)...
- 92 Ventilation dampers - 78 of which required manual operation...
- Carbon Dioxide (CO₂) / Halon / Foam - fixed firefighting systems to some machinery areas..
- 7 Breathing Apparatus sets...
- 9 Hand held radio's..

The ship satisfied existing SOLAS (safety of Life at Sea) requirements and met IMO (International Maritime Organisation) regulations

So why did 158 people die????

History...

- The ship was owned by the ‘Seascope’ company...
- Two sister ships had suffered ‘fire’ incidents...
- No dedicated crew training prior to departure...
- Only 60% occupied at time of fire.

Ships plan...digi!!!

Scenario...

- 2145 hours on 6th April 1990 - left Oslo...
- 0145 hours on 7th April - a 'small' fire was extinguished outside cabin 416; port side - **NO FURTHER ACTION TAKEN...**
- 0200 hours -further fire reported outside cabin 419; starboard side (this was mainly vacant cabins.The fire alarm was operated initially on 4 and 5 decks...

continued...

- 0210 - Fire spreads upwards via stairs to 4;5 and 6 decks, laterally via passageways and fills long 'dead end' passageways...
- 0224 - MAYDAY sent - ship being abandoned...
- 0230 - Ventilation crash stopped. (45 minutes after first alarm) . Ship is stopped...
- 0250 - First rescue ship on scene...

and...

- 0320 - Captain and some crew abandon ship...
- 0335 - First helicopters arrive...
- 0530 - Shorebased Swedish Firefighters arrive...
- 1155 - Towed to Lysekill, Sweden...
- 2117 - Vessel docks...

1800 hours, Sunday 8th April 1990 - Fire extinguished.

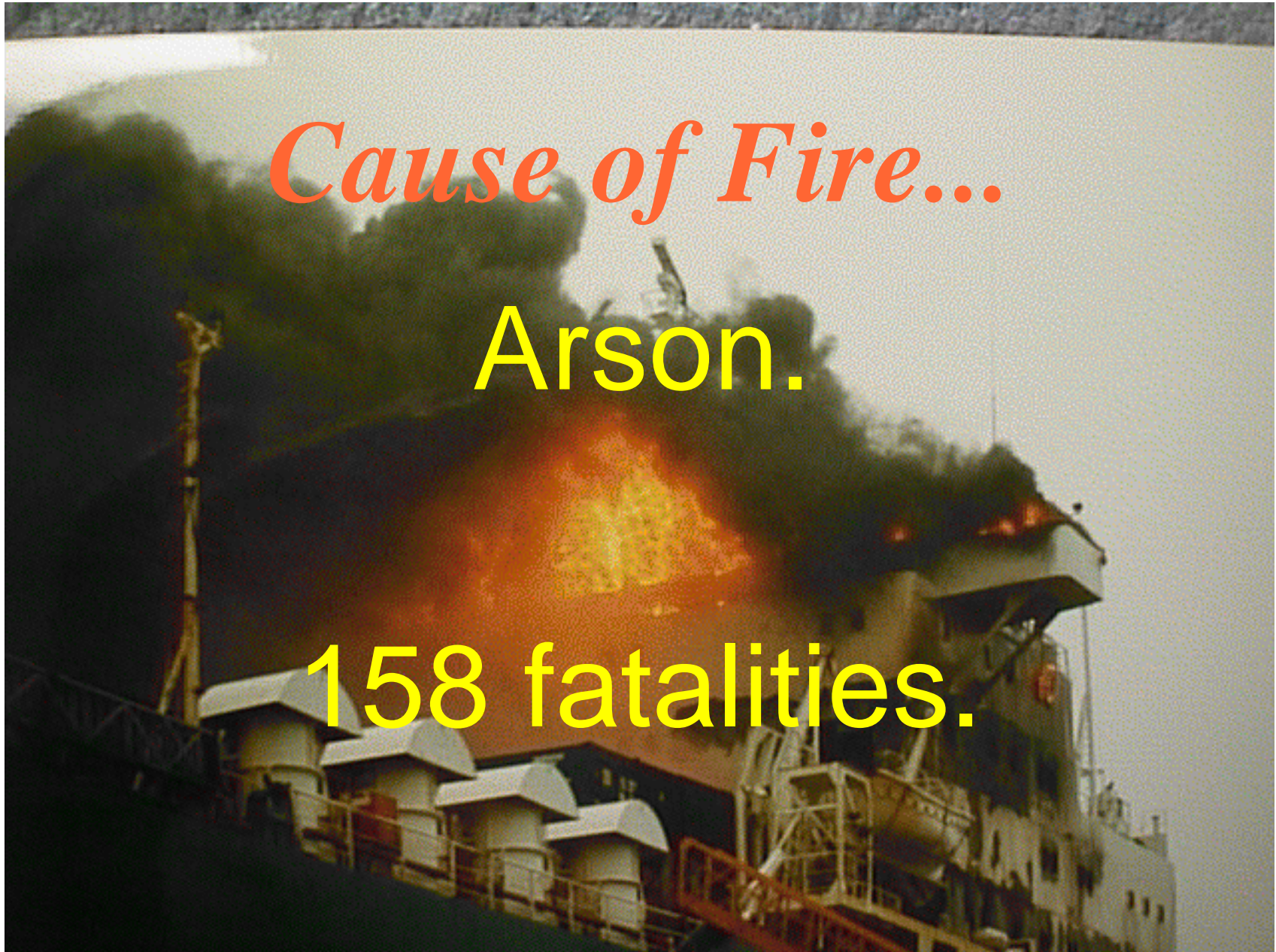

Cause of Fire...

Arson.

158 fatalities.

Pics..digi...

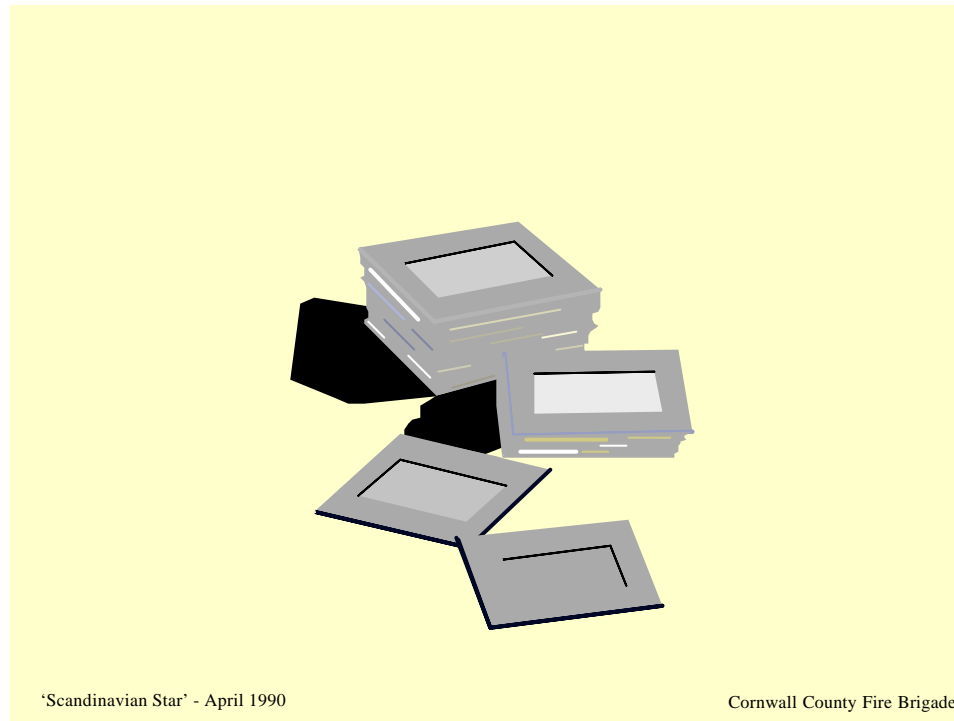

'Scandinavian Star' - April 1990

Cornwall County Fire Brigade

The Norwegian government
commissioned an enquiry following the
incident.

There were three main conclusions..

- Lack of training...
- Failure of 'passive' fire protection...
- Poor command and control.

Subsequently several major recommendations were made by the committee of investigation. These recommendations would apply to vessels operating in Scandinavian waters. They were as follows...

Training..

- Regular crew training at approved training centres...
- Pre sailing safety inspections...
- Stricter ship fire patrols...
- Use of additional Breathing Apparatus...
- Passenger smoke masks..

Fire precautions...

Install comprehensive 'active' fire safety equipment...to include:-

- Continually sounding fire alarms at 75dBa...
- Ventilation to be automatically controlled...
- Fire doors to have vision panels. Doors to be controlled by fire detection...

continued...

- Reduce 'dead end' passageways...
- Improved sign posting and escape lighting; high and low...
- Limit the use of combustible materials...

and...

...early assistance from
shorebased Firefighters where
the situation permits.

Summary

- In December 1992 Captain Hugo Larsen and the Chief Officer were sentenced to 60 days prison...
- The company's managing director was sentenced to 40 days prison ...
- Could it happen around our coasts ...and if it does , are we prepared???

Standard Operational Procedure

THE USE OF HELICOPTERS FOR UK FIRE BRIGADES - 'OFFSHORE OPERATIONS'

Summary:-

Inter Agency agreement reached between United Kingdom SAR organisations and participating coastal Fire Services for the adoption of best practice in the role of mobilising UK Fire Brigade resources via helicopter to firefighting, rescue and chemical hazards on vessels at sea.

Further Information:-

MOU between MCA and the Fire Service.

DCOL 9/92

Version 4 (Final Draft)- May 2000

Contents	Page
KEY INFORMATION:-	
STRATEGIC ASSESSMENT	2
INITIAL MOBILISATION	3
OPERATIONAL COMMANDER - AIDE MEMOIR	4
PRIMARY INFORMATION:-	
1. Introduction	
2. Command and Control	5
3. Response Criteria	5
4. Teams	5
5. Embarkation	5-7
6. Equipment / Communications	7
7. Helicopter Loads, Distribution and Seating	7
8. Personal Equipment	8
9. Welfare of Personnel	
10. Clothing	8-9
11. Training for Helicopter Operations	9
	9-10
SUPPORTING INFORMATION:-	
12. Terms of Reference	10
13. Criteria for Response	
14. Mutual Assistance	11
15. Combined Training and Liaison	11-12
	12
Appendix 1...Tasking Form	12
Appendix 2... Nominal Roll Form	
Appendix 3... Operational Equipment	13
Appendix 4... Equipment Weights	14
Appendix 5... Aircraft	15
Appendix 6... Load Bags (Specification)	16
Appendix 7... Glossary	17-19
	20-22

Implementation Date:.....Review Date (Two Yearly):.....23.....

By whom:...CACFOA- MOG

KEY INFORMATION - SHEET ONE

STRATEGIC ASSESSMENT

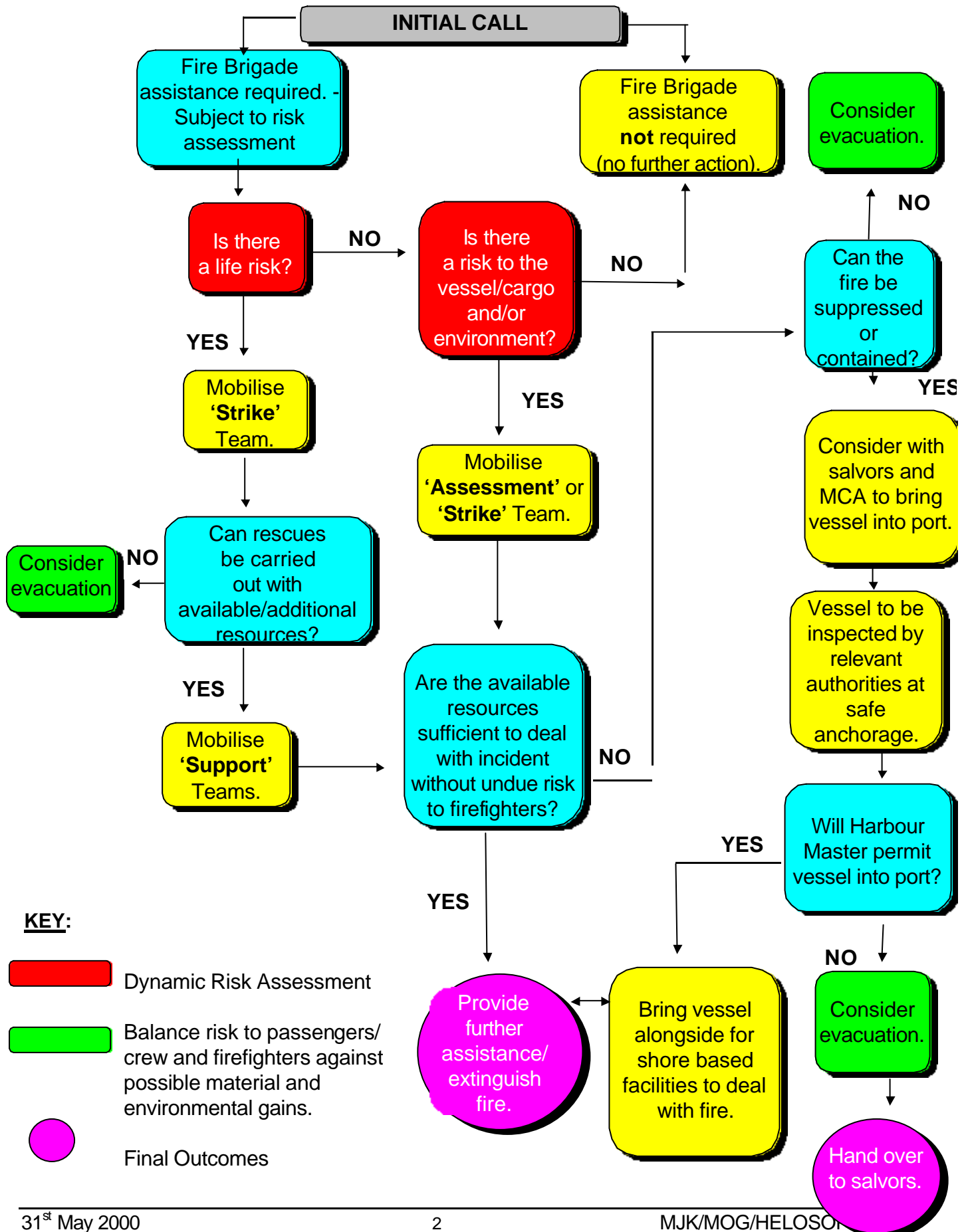

KEY INFORMATION - SHEET TWO

Initial Mobilisation

THE FOLLOWING MUST BE COMPLETED:

INITIAL COMMAND MEASURES.....

OBTAIN FULL DETAILS VIA TASKING FORM (*See Appendix 1*)

ALERT APPROPRIATE RESPONSE TEAMS
(*See Key Information - Sheet 1*)

ADVISE NEAREST PARTICIPATING BRIGADES -
(*Mutual Assistance, see Section 14*)

DESPATCH OFFICER TO LOCAL MCA CENTRE FOR LIAISON

ENSURE EMBARKATION OFFICER IS APPOINTED

TEAM TO SAR RV - ADVISE MCA

DEPLOYMENT PROCEDURES...

TEAM HELO.SAFETY BRIEF AND INCIDENT UP-DATE

ENSURE NOMINAL ROLL COMPLETED (*See Appendix 2*)
Shut down all handheld comms. for transfer.

'Strike / Support' teams only - CONFIRM WEIGHTS WITH SAR WINCH OPERATOR

SENIOR FIRE OFFICER e.g OPERATIONS COMMANDER (OC) TO COMMUNICATE WITH PILOT AND SITS NEAR DOOR

OVERFLY VESSEL FOR RISK ASSESSMENT (RA) (*Assessment / Strike teams only*)

- NOT SAFE TO BOARD - RETURN TO RV
- SAFE TO BOARD - 'OC' OR WINCH MAN TO DECK
- FIRE No.2 (*Command Support*) TO DECK

FURTHER RA AND CONFIRMATION THAT FIRE BRIGADE ASSISTANCE IS REQUIRED FROM MASTER

EQUIPMENT TO VESSEL

REMAINING TEAM MEMBERS TO VESSEL

PROVIDE SITREP TO MCA

ACTIONED
(Tick)

KEY INFORMATION - SHEET THREE

'OPERATIONAL COMMANDER' AIDE MEMOIR

YOU ARE NOW ON BOARD THE CASUALTY:

ADVISE MCA OF ARRIVAL AND NUMBERS ONBOARD - INSTIGATE
'BOARDING' PROCEDURE

LIASE WITH SHIP'S MASTER

ESTABLISH AN EVACUATION / ABANDON SHIP MUSTER POINT AND
PROCEDURE. BRIEF FIRE TEAM.

ESTABLISH A COMMAND POINT - *normally ship's BRIDGE*

CHECK COMMUNICATIONS LINKS WITH MCA

SURVEY INCIDENT - CREWS MUST WORK IN PAIRS

CONFIRM STAND-BY VESSEL / SAR AVAILABLE FOR EGRESS

CHECK FIXED INSTALLATIONS AVAILABILITY

CONSIDER LOCATION OF FORWARD CONTROL POINT

DYNAMIC RISK ASSESSMENT RE-EVALUATION

MAXIMISE USE OF SHIP'S PERSONNEL - GUIDES ETC.

PREPARE FOR '*Strike*' / '*Support*' TEAMS IF 'OFFENSIVE' TACTICS BEING
CONSIDERED

BA TEAMS TO BE MINIMUM OF THREE

ESTABLISH REST AND RECOVERY AREA NEAR EVACUATION / ABANDON
SHIP MUSTER POINT IF POSSIBLE

MAINTAIN 20 MINUTE BRIEFINGS (INCLUDING ROLL CALLS) WITH ALL
PERSONNEL / MCA / FIRE SERVICE CONTROL OR LIASION OFFICER AT
MRC / MRCC

**ACTIONED
(TICK)**

PRIMARY INFORMATION

1. INTRODUCTION

This document summarises 'Best Practice' regarding arrangements for helicopter operations for firefighting, chemical hazards and rescue on vessels at sea and has been compiled via the CACFOA 'Offshore Firefighting Networking Group'. This group comprises representatives from United Kingdom coastal Fire Brigades and SAR organisations including the Maritime Coastguard Agency (MCA), Royal Navy (RN) and Royal Air Force (RAF)

Although the primary use as indicated is for vessels on fire at sea and does not include reference to none SAR helicopter operations e.g police helicopters, some of the practices identified may be suitable for other areas of Fire Service operations.

2. COMMAND AND CONTROL

Command and Control for these incidents is based on the principals of the Incident Command System (ICS) as defined in the Fire Service Manual - Volume 2 - Incident Command.(Published 1999)

In that respect the Incident Commander (IC) is in overall charge of the incident and will remain ashore at the local MRC/MRCC. The Operational Commander (OC) will be dispatched to the casualty with his / her 'Command Support'.

These Command Team Officer's will be identified by the appropriate tabards, which also display the relevant role.

3. RESPONSE CRITERIA

- Request from MCA for assistance.
- Request from another source that is approved and supported by the MCA.
- Approved by Fire Brigade Principal Officer - where there is an immediate risk to life or high risk of an incident developing that will have a serious environmental impact.

HELICOPTER 'STRIKE' TEAMS ACTING IN ISOLATION WITH LIMITED RESOURCES SHOULD NOT INITIATE 'OFFENSIVE' TACTICS. HOWEVER, FOLLOWING A DYNAMIC RISK ASSESSMENT (DRA) THE OPERATIONS COMMANDER MAY INITIATE LIMITED ACTIONS e.g SNATCH RESCUES

The defined task will be to provide actions and make provisions for when additional resources become available.

4. TEAMS :-

'ASSESSMENT' TEAM

When appropriate, e.g. only limited information is available, no immediate risk to life - an assessment team may be initially dispatched to carry out risk assessment before committing additional resources.

Composition

- Minimum of two Officers with the relevant competencies...the 'assessment' team may form part of a larger 'multi agency' response
- The team should wear full PPE i.e immersion suit and lifejacket and carry a minimum of equipment as follows:-
 - Welfare packs (2kgs)
 - Marine band radios.. two (1kg)
 - Heavy duty torch (1 kg)
 - Thermal Image camera (8kg)
 - Command Wallet / Notebooks / Dictaphone(2kg)

Purpose

- To provide professional advice on matters relating to fire.
- Provide first impression information.
- Transmit a full situation report via Coastguard coordinating station.
- To provide the Fire Brigade Principal Officer with risk assessment information to enable decision on further deployment to be made at the strategic level.

'STRIKE' TEAM:

Normally mobilised when full information is available and / or immediate threat to life on the casualty

NOTE:-

Any subsequent teams can only be 'Support' team(s) who's composition must be determined by the OC in liaison with the IC (shore-based), taking into account the balance of need i.e. personnel or equipment.

Composition

Minimum team of six, with pre designated equipment bags - One - Two - Three (see Sections 6 and Appendix 3).

Minimum of two Officers with relevant competencies if no 'Assessment' team previously mobilised.

This will provide an Operations Commander and / Command Support.

The final decision for deployment of personnel to the casualty will rest with the OC.

The 'Strike' team consists of only Fire Service personnel

Purpose

- Carry out a risk assessment (as per the 'Assessment' team if not previously deployed).
- Collect information - see *KEY INFORMATION sheets*
- Transmit a full situation report via the coordinating MCA.
- Make provision for: Command and Control, Safety, Welfare and Communications.
- To provide the Fire Brigade Principal Officer with a risk assessment to enable decision on further deployment to be made at the strategic level.
- Request necessary resources to enable the incident to be dealt with effectively. The resources requested should be prioritised to enable proper logistical planning by onshore organisation.

'SUPPORT' TEAM(S)

When all assessments have been concluded the OC may take the decision that some 'Offensive' tactics are necessary. Support teams will need to be mobilized to ensure these actions can be carried out with maximum safety and appropriate resource support.

Further resources may be committed via a seaborne transfer.

'Support teams' may be mobilised from other participating Brigades.

The OC must ensure that suitable, safe means of egress are available from the casualty for all those persons who will eventually be onboard. This may include the use of helo, standby vessels or the casualties own evacuation equipment.

Ultimately the number of personnel onboard the casualty will be down to local agreements.

Composition

At the discretion of the OC in liaison with the IC (shorebased), taking into account the balance of need i.e personnel or equipment.

Account must be taken of helo carrying capacity. Maximum payload of 2500lbs/ 1125kgs.(See Appendix 5 re aircraft 'types' and configuration)

Purpose

- to support 'Strike' team
- to carry out tactical firefighting and rescues as determined by the OC

5. EMBARKATION

In all circumstances a nominal roll form (Appendix 2) should be completed to record all personnel taken offshore. Copies of this should be FAXED to HM Coastguard, HM Customs and the HM Immigration Office which covers the Service/Brigade where the incident has occurred. With HM Coastguard being the central coordinator in cases of repatriation, if this becomes necessary.

In the case of firefighters returning to shore, their Fire Control Centers must fax their names to HM Coastguard to ensure nominal rolls are always current.

Prior to departure / embarkation all crews must have received a pre flight safety brief. This must include details on the aircraft to be used, appropriate use of PPE .e.g. eye, ear protection, methods of approach, seating and equipment location, disembarkation and emergency procedures.

The pilot may require illumination of the landing zone when collecting or returning crews, this may be done by the use of two fire appliance's headlights directed in a vee shape on the landing zone. Night vision goggles may be used by the aircrew in these circumstances, strong torches etc should never be shone directly at the aircraft.

NB. The Coastguard may be mobilised to secure the landing site.

6. EQUIPMENT / COMMUNICATIONS

The teams, personnel and equipment should meet the following:

- Current standards for the safety and protection of personnel during transportation, transfer and activities on board vessels in need of assistance.
- Current standards for the safety and protection of personnel during firefighting and associated activities.
- Enable personnel to communicate to the relevant rescue co-ordination centre.
- To ensure agreement on commonality of specified equipment, load bags will be identified and contain equipment as shown in Appendix 3.
- Approved loading bags must be used that meet the following criteria:-

Maximum dimensions.....

Sling heights.....
Base specification....
Method of clearly displaying contents.
Identify safe working load (SWL), and be tested and recorded.
(Suggested specification for load bags is shown in Appendix 6)

All portable radio equipment including cellphones, taken on board a helicopter must be switched OFF and must not be operated inside the helicopter.

Radio communications for the Fire Service Crew whilst on board the helicopter will be provided by the helicopter crew.

Communications with the aircraft will only normally be available via VHF Marine wave band radio's. Crews operating on the ground, without assistance from a member of the aircraft's crew, should always maintain communications with the helicopter.

7. HELICOPTER LOADS, DISTRIBUTION AND SEATING

Maximum loads may differ for different types of helicopter. In all cases the maximum load will be at the direction of the helicopter loadmaster or pilot.

Loads must be secured within the aircraft by the 'loadmaster'.

Fire Services should have available prepared equipment lists with weights in lbs/kgs to cover all the equipment likely to be utilised. Weight calculation charts should also be incorporated and account must be taking of Manual Handling regulations.

Appendix 3 details equipment loads for 'strike' team. Further specific loads for 'support' teams will depend on the nature of the incident. However, it is anticipated that equipment dumps will be prepared at helicopter landing sites.

The distribution of loads and seating of personnel is the responsibility of the pilot. Suggested seating plans are shown in Appendix 5.

The seating arrangements should be such that the Fire Service Commander is able to:

- Carry out visual reconnaissance...
- Egress the aircraft to the deck of the casualty first...
- Link to the aircraft communications systems.

NB.

Equipment carried by waterborne response may be subject to helo transfer and therefore should comply with the above criteria.

8. RECOMMENDED STANDARDS OF PERSONAL EQUIPMENT

Lifejacket

Lifejackets must be approved to meet the current standards required by military and CAA for airborne use.

NB.

Local procedures should be in place with the 'carrier' to ensure lifejackets cannot auto inflate during transit

Immersion / Transit Suits

Immersion / Transit suits must be approved to meet the current standards required by military and CAA for airborne use.

Immersion / transit suits for helicopter use are the minimum requirement for travelling by helicopter and are to be worn at all times during transportation.

Head Protection

A Fire Brigade helmet with chin strap fastening and built in visor is the minimum standard.

Ear Protection

Appropriate ear protection should be made available to all personnel prior to embarkation, and guidance given on their use.

Ancillary Equipment

All personnel should be afforded the appropriate level of personal protection and safety equipment which may include:

- The provision of a supplementary air device.
- Safety belt with pouch, personal line and karabiner.
- Cylume chemical lights.(to be worn at night on board vessel)
- Torch.

9. WELFARE OF PERSONNEL

To be able to provide personnel with such equipment as they need to sustain them for a reasonable period of time offshore, should arrangements not be available on board the vessel or standby vessel(s), welfare packs should be provided.

The exact nature of welfare packs is not stipulated, however, the following should be considered:

- Hot packs
- Drinking Water
- High Energy Bars
- Toilet Paper
- Face Wipes
- Hand Cleaner
- Sea Sickness pills / Seabands

Personnel who require to take seasickness tablets (subject to advice from Brigade Occupational Health) must ensure these are taken before embarkation (some tablets may cause drowsiness and this needs to be taken into account). Sea wrist bands provide some protection from seasickness and may be considered an alternative to seasick tablets.

All personal equipment and food could, if required, be carried in a personal holdall which the individual could retain during the flight and winching operation

This equipment must be limited in weight to the extent that it will not increase equipment levels beyond the maximum weight limits allowed for helicopter transport

Consideration must also be given to immigration provision, where firefighters may land in a foreign country and may have welfare needs prior to repatriation. (*See also Section 5*)

10. CLOTHING

If personnel are committed to a fire or chemical situation of any significant size it would be desirable to provide them with a complete change of clothing as their own may have become

wet through penetration of water or excessive sweating. The clothing must be compact, windproof and easily carried but must provide warmth and comfort to the wearer. Consider the following:-

- Thermal Underwear
- Overalls/One Piece Suit
- Socks

11. TRAINING FOR HELO OPERATIONS.

Training for operations needs to be developed via local training needs analysis. However in consultation with MCA and CAA the following should be considered:

GROUND TRAINING

- brief on aircraft statistics
- approaching the aircraft, hazards e.g 'downwash', debris, PPE
- boarding aircraft to include identification of Fire Commander (OC),
- seating plan and moving around the aircraft
- communication
- preparation to winch
- winch procedure - including 'high line'
- loading and storage of Fire Brigade equipment
- indication of ditching/crash procedures
- bracing position
- post impact procedure
- emergency exits
- escape procedure

AIR (FLYING) TRAINING

- take off and landing procedures
- winching from and to the aircraft ~ crew and equipment including 'high line'
- communication with aircraft including ground to air signals

SEA SURVIVAL TRAINING

Brigades carry out sea survival training to maintain the relevant competencies and this includes the use of:

- lifejackets
- immersion suits
- life rafts
- lifting from the water

ADDITIONAL TRAINING PROVIDED MAY INCLUDE:

- Welfare e. g use of ear defenders, anti nausea provisions, etc
- wet winching drills, i.e. whilst wearing full PPE will be recovered by helicopter from the water by winch after exiting life raft.

SUPPORTING INFORMATION

12. CACFOA 'OFFSHORE FIREFIGHTING NETWORKING GROUP' - TERMS OF REFERENCE

On behalf of offshore firefighting practitioners, to draw together offshore incident procedures including training and equipment.

To liaise with the MCA who are the overall coordinating authority, Royal Navy and Royal Air Force Search and Rescue regarding the appropriate 'at sea' response.

Specific areas considered by the working group included:

- Criteria for authorisation and alerting Fire Services responses.
- Minimum training.
- Composition of offshore teams.
- Standard list of operational equipment to meet the needs of the respective roles of the above teams.
- Minimum standards of PPE
- Response and assembly times
- Mutual assistance between the participating Fire Services
- Welfare of personnel
- Combined training and liaison arrangements

13. CRITERIA FOR RESPONSE

The MCA will seek the help of the relevant Fire Service after receiving a request for Fire Service assistance from the Master of a vessel at sea. It is considered that Fire Services/Brigades may respond to calls for assistance particularly where life is at risk. The decision to attend or not will be made by the appropriate Chief Fire Officer or his/her nominated representative.

Those Fire Services/Brigades that participate should declare availability to MCA. Any changes to 'declared assets' must be communicated to MCA immediately

The Chief Fire Officer Firemaster or his/her representative will require specific information before committing the resources of his Fire Service. The form detailed in Appendix One should be used for this purpose. In the first instance HM Coastguard should attempt to complete those items asterisked and in bold print. This should also be faxed to the Fire Service by the coordinating HM Coastguard station. Subsequent information can be added when required by the Coastguard.

Although the helicopter approach to a vessel in difficulty is by far the fastest response, it cannot be guaranteed that the helicopter can remain on scene indefinitely. To ensure the safety of firefighters on board a casualty vessel that is either on fire or disabled, firefighters should not be allowed on board a casualty vessel unless a satisfactory risk assessment has been completed..and suitable egress is available. Suitable means of egress to include:Helicopter, RNLI lifeboat and ships life saving equipment, tug, rig support vessel or similar is on scene or in contact with the Coastguards and en route to the incident. If no line of safe retreat is to be identified by the RA, then boarding of vessel will not occur.

In order to provide early notification to neighboring Fire Services of an incident at sea, the Fire Service attending such an incident would take steps to notify participating Fire Services as soon as possible after the initial call. Arrangements should also be set up to notify adjacent Fire Services of relevant "Informative and Stop Messages".

In the event of the MCA being unable to agree the attendance of the local Fire Service (first Fire Service) to an incident at sea they would obviously attempt to obtain the services of an adjacent Fire Service (second Fire Service). In such circumstances the second Fire Service should contact the first to establish why they had declined to make an attendance.

14. MUTUAL ASSISTANCE

Intention of Mutual Assistance: There is a general agreement between participating Fire Services that when requested, they will supplement each other resources. This agreement is intended to cover eventualities when the demands of an incident at sea exceed the resources of the first Fire Service.

Application: the Principal Officer of the host Brigade will advise neighboring Brigades that participate in the mutual assistance agreement, of the host Brigades intentions so resources can be made available at the earliest opportunity to reinforce. The MCA must also be advised as the requirement for helicopter transfer between Brigades will be required.

Before any attempts are made to react to a request for mutual assistance, the host Fire Service must seek the agreement of the respective Fire Brigade Principal Officer(s).

15.COMBINED TRAINING AND LIAISON

Fire Brigades participating in offshore incidents that involve the use of helicopters as a primary mode of transport should carry out training with the appropriate 'carrier' and also with other key agencies e.g MCA and 'mutual assistance Brigades

Training should include testing of mobilising procedures, communication functions and the ability to respond to a request for mutual aid. Brigades must ensure that when mutual aid training is carried out, personnel are made aware of any relevant differences in command and control procedures, key equipment and communication systems

TASKING FORM

THIS FORM SHOULD BE HELD AND COMPLETED BY THE LOCAL MRC/MRCC

INFORMATION REQUIRED FROM MCA (Initially that information in bold and asterisked MUST BE SENT). DO NOT DELAY IF INFORMATION IS INCOMPLETE.

FAX TO RELEVANT BRIGADE/FIRE AND RESCUE SERVICE						TIME:-	
MCA CO-ORDINATING RESCUE CENTRE							
NATURE OF EMERGENCY AND COMPARTMENT INVOLVED*							
POSITION OF VESSEL - COURSE*							
VESSEL NAME*						DWT/GT*	
TYPE OF VESSEL *		TOTAL NUMBER OF PERSONS ABOARD*			CREW*	PASSENGERS*	
Owner/Agent:		Are Persons Trapped or Missing Aboard*			Yes	No	
Nature of Cargo*:		Nationality of Master/Crew:					
		Interpreter Required			Yes	No	
Hazards that could affect Fire and Rescue operations:				WIND ON SCENE, SEA STATE ON SCENE AND AREA FORECAST*			
Ship's Fire Pumps Operative		Capacity Tons/ Hour	Fixed Fire Installations. Has it been Operated?		Yes		No
Yes	No		Type	CO2	Halon	Sprinkler	Others Specify
Communications facilities on board vessel:			Yes	No	Stability problems:		
HELICOPTERS AVAILABLE*		SEA KING(RN/MCA)		SEA KING RAF		SIKORSKY	
Lift Capability at Time of Tasking:		<input type="checkbox"/>		<input type="checkbox"/>		<input type="checkbox"/>	
Landing Site for Helicopters:							
Vessels Available for Transportation:			Name			Type	
Loading Point:							
Other Vessels going to Assist:							
ADDITIONAL INFORMATION (e.g. 'Details of Fire Operations Commander'):							

OPERATIONAL EQUIPMENT

The following are standardised minimum loads and will be the expected equipment to arrive when requested from any participating Officer.. regardless of Brigade. See also Appendix Six

BAG 1 ~ 'STRIKE TEAM'

	KGS	LBS
BAG AND BOX (optional)	10	22
2 CABA SETS c/w LIGHTWEIGHT CYLINDERS	30	67
BA CONTROL BOARD	5	10
THERMAL IMAGE CAMERA	8	18
FIRST AID KIT	1	2.2
2 HEAVY DUTY TORCHES	3	7
2 HANDHELD RADIOS (VHF) AND WATERPROOF COVERS	2	5
SPARE BATTERIES FOR RADIOS	5	10
TOTAL	65	142

BAG 2 ~ 'STRIKE TEAM'

BAG AND BOX (optional)	10	22
2 CABA SETS c/w LIGHTWEIGHT CYLINDERS	30	67
BOARDING CONTROL BOARD (design to be agreed)	7	16
4 'HEAVY DUTY' TORCHES	4	9
4 HANDHELD RADIOS (VHF) AND WATERPROOF COVERS	6	14
GUIDE TAPE or 'TRANSIT' LINE	4	9
TOTAL	61	134

BAG 3 ~ 'STRIKE TEAM'

BAG AND BOX (optional)	10	22
2 CABA SETS c/w LIGHTWEIGHT CYLINDERS	30	67
2 FIELD TELEPHONES(optional)	4	9
CABLE REEL (for above - optional)	7	15
WELFARE PACK (See Section 9)	15	34
BA GUIDE LINE	2	5
TOTAL	68	150

Brigades need to be aware that the OC may request additional operational equipment via 'Support teams' and that due to its weight will have an implication on helo loads.

Brigades should therefore have available prepared equipment lists with weights in Kgs/lbs to cover that equipment likely to be utilised for offshore operations.

EQUIPMENT WEIGHT CHART(Example)

Any further equipment required by the Offshore team needs to be evaluated by the Operational Commander. He / she must be provided with the appropriate information so the correct assessment can be taken. This detail must be available for participating Brigades and carriers.

Examples as follows:-

Contents	Kilo's	Pounds
1 BAG AND BOX (optional	10	22
2 45mm x 25M Hose	18	40
1 3 Way Dividing Breeching	4	9
4 Torches - Heavy duty	7	15
2 CABA SETS complete	30	67
2 Branches (Elkhart)	5	8
1 15M Line	3	7
1 BA Service Kit	3	7
1 Stability Board	4	4
1 Ship's Log	1	2
1 Guide Line	2	5
1 Shifter Wrench	1	2
2 Welfare pack e.g Hot Cans etc	22	46
1 Box rags	12	26
10 Spare Overalls	10	22
10 PVC coats	12	26
2 Large Axes	5	8
1 30M Line	6	14
4 Cans fresh water		
4 Branches - 'Fogfighter'		
1 Snatch Block		
1 Wrecking Bar		
1 Fall Arrest Device / Body harness		
1 Ship / Shore couplings		
1 Cellar nozzle		
1 PPV Fan		

Account must be taken of available aircraft payloads and manual handling restrictions.

AIRCRAFT TYPE AND LAYOUT

SEA KING (RAF)

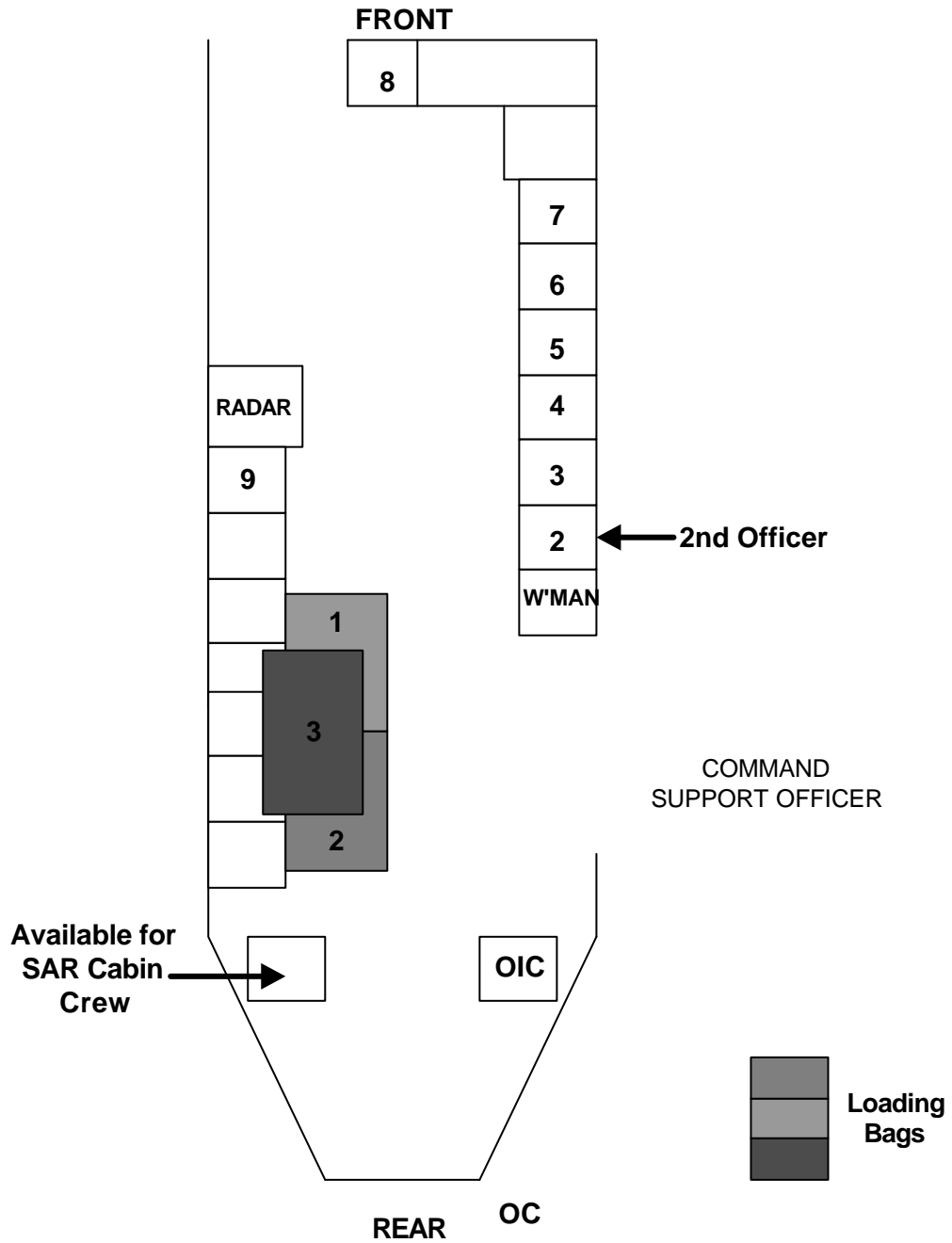

SIKORSKY S61 (MCA)

FRONT

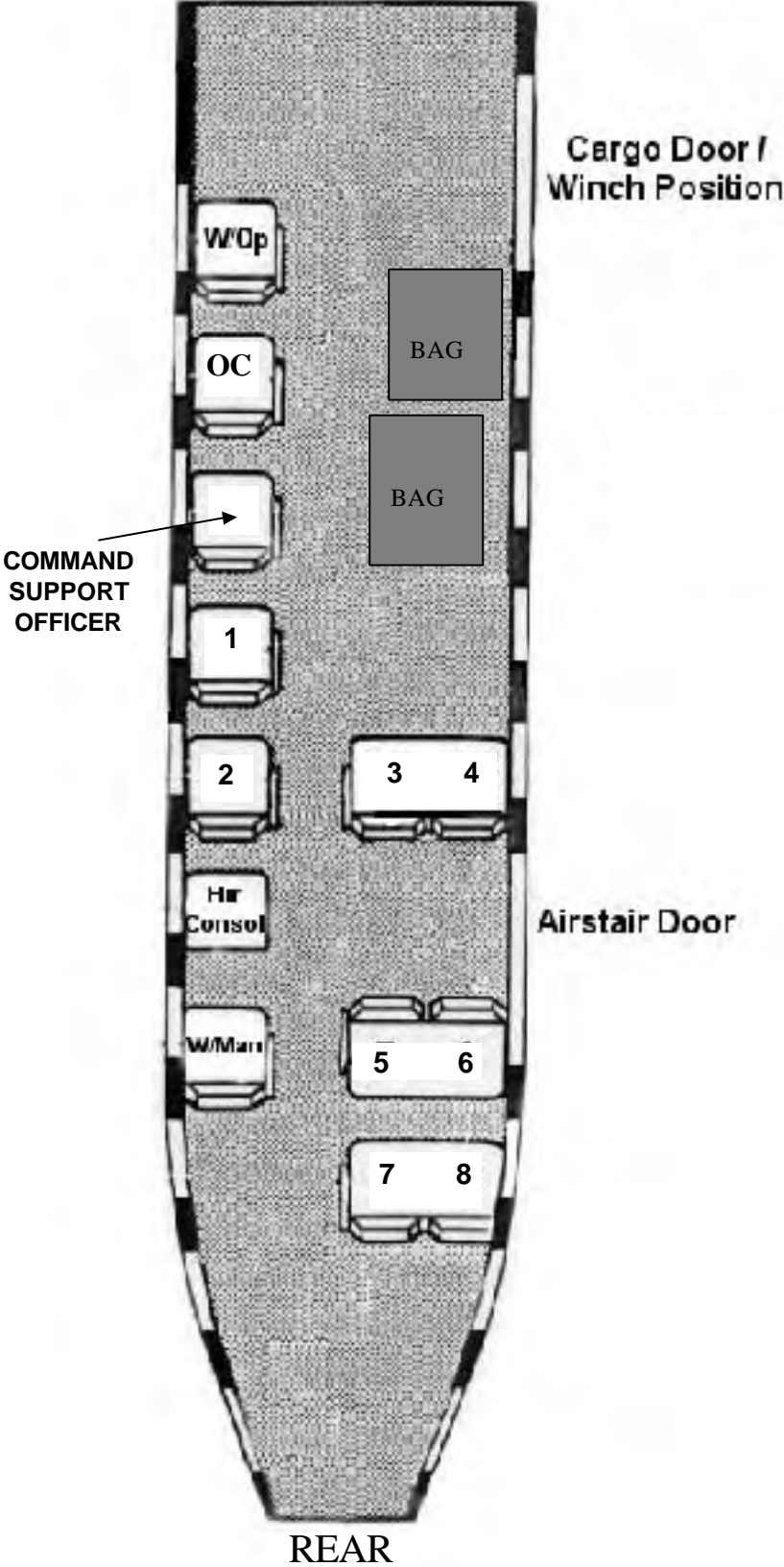

REAR

SEA KING MK 5 (RN)

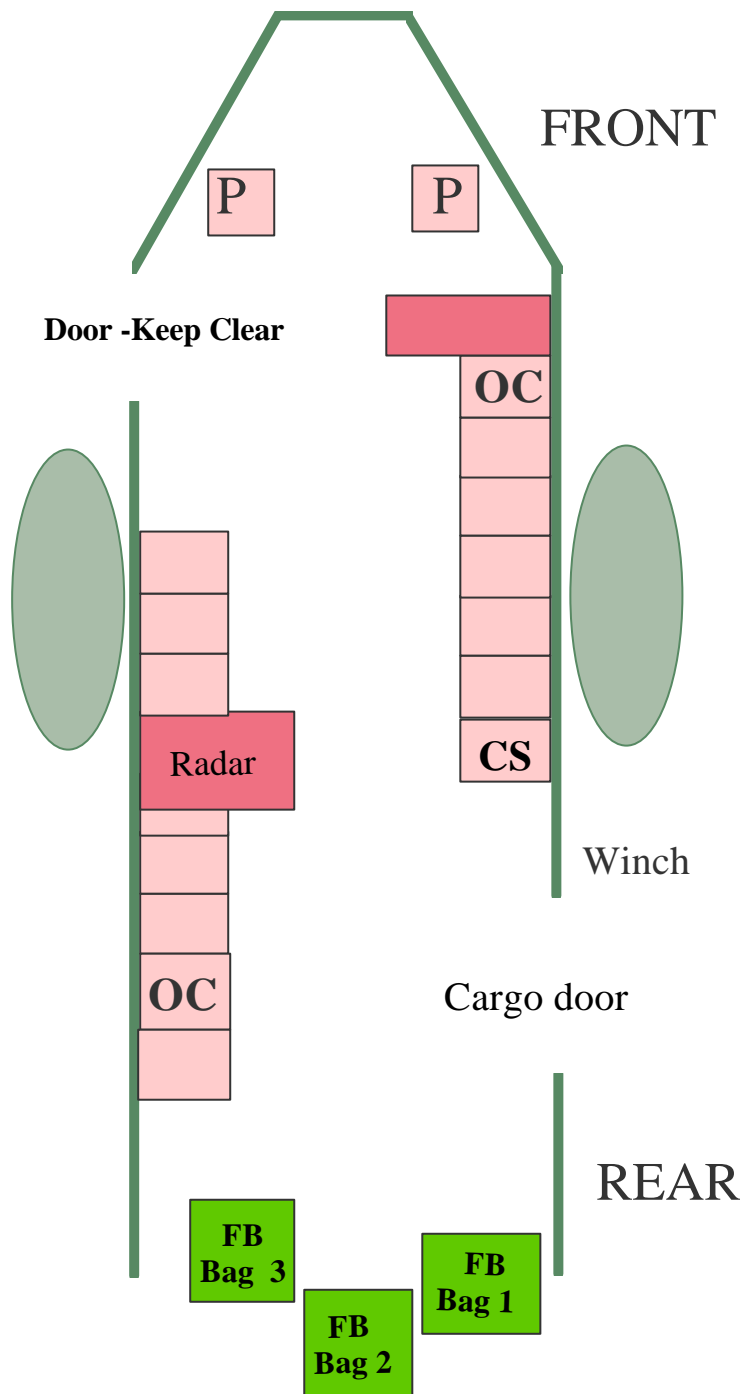

(The Fire Brigade Operations Commander may be seated in either of the seats shown OC as determined by pilot. (The OC will be provided with a headset for communications.)

CS ~ Command Support Officer.

SUGGESTED SPECIFICATION FOR HELICOPTER LOADING BAGS

GENERAL

The primary role of the helicopter loading bags is to transport equipment via helicopter and / or sea going tug to incidents offshore in a compact and easily manageable bag, that has been approved for use by helicopter crews.

The loading bags should be constructed of best grade materials and be manufactured to the latest European / British standards and best industry practice with regard to the following:

Materials of construction
Methods of manufacture
Resistance to wear
Proofing against corrosion or deterioration from sea water.

MATERIALS

7oz Pu Nylon Outer covering / 10mm Plastozote Foam sandwich / 4oz Pu Nylon inner
PVC Nylon base / Glass fibre tray / 8mm Heavy duty zip closure
50mm Heavy duty webbing / Stainless steel rings with carabiner

COLOUR

The overall colour of the bag is to be High Visibility Orange
The rubbing band and Webbing straps are to be coloured black
Handle straps to be coloured yellow. / The fibre glass base tray to be coloured red. _

ZIPS

The zips used should be watertight and resistant to the effects of salt water
The zip closure around the top three sides of the bag is to be 8mm heavy duty type, opening from left to right.
The zip closure for the drag / securing strap side pouch is to be 6mm heavy duty type opening from left to right.

STEEL RING AND CARABINER

Stainless steel rings to be 60mm with working load of 150kg. To extend above the bag by 330mm on webbing straps (excluding rings).
The Carabiner is to be a heavy duty type with a matching working load as that of the steel rings. The Carabiner is to be attached to the side of the bag by a 3m x 50mm webbing strap for the purposes of dragging or securing the bag.

BASE

The base of the Helicopter loading bag is to be constructed of two parts, an inner and outer.
The outer base (Bottom tray) is to be constructed with large radii corners to avoid damage to helicopter flooring with sharp angular corners. Size is to be 635mm x 915 nominal 8 gauge manufactured from glass fibre.

The inner part of the base is to be constructed of 6mm ply measuring 610mm x 870mm.
The bases are to be secured through the bottom of the bag and through the webbing straps by pop rivets or other suitable fixings.

HANDLES

Six yellow webbing covered rope handles 300mm long on 800mm centres, boxed stitched on either side of the eyelet. One handle to be sited on each short side of bag and two handles on the longer sides of the bag.

One 50mm x 3m webbing strap for securing or dragging purposes to be secured to one end in a suitable zipped pouch / pocket.

RUBBING BAND

A 200mm Rubbing band stitched to the bottom of the bag manufactured from black PVC Nylon

WEBBING STRAPS

All 50mm webbing is to be of 150kg working load

LABEL POUCHES

Two A4 size clear label pouches on the top of the loading bag with facility for easy insertion and removal of A4 size labels.

SEAMS

All seams are to be double stitched

SIZES

The dimensions of the helicopter loading bag are :

Length - 915mm

width - 635mm

height - 635mm

60mm Stainless Steel rings secured to the webbing straps 330mm above the top of bag. Carabiner attached to a 3m x 50mm webbing strap.

Rubbing band 200mm

Top zip closure 8mm

Securing strap pocket zip 6mm

LETTERING AND INSIGNIA

The lettering 'ANYWHERE' FIRE BRIGADE " to be stencilled / dyelined on one of the longer sides of the bag to a size of 50mm..

An 'sponsorship' badge approx. 200mm mounted approx. 100mm above the lettering.

The relevant Manual handling regulations symbol to be attached in a highly visible section of the bag.

NOTE

The requirements of this specification are to be regarded as minima (or maxima as the case may be) and nothing herein is to be construed as tending to prevent the purchaser from specifying stricter or additional requirements in any direction to meet special circumstances.

Items offered must be of a suitable manufacturer. Where the word "Approved" is used this means approved by 'Anywhere' Fire Brigade.

The materials used will be in accordance with the requirements as stated in the specification and to be of the best quality available for the purpose.

They will also be subject to approval by 'Anywhere' Fire Brigade.

It is most important that where the appointed contractor has a query on any part or paragraph of the specification that this shall be discussed, and that any approved variation be agreed in writing prior to the commencement of any work on the helicopter loading bags.

There being no variation in the specification without the approval of the Brigade Marine Operations Group and Chief Fire Officer.

Glossary of Terms

BABreathing Apparatus_

CACFOA.....Chief and Assistant Chief Fire Officers Association.

CASUALTY...MCA terminology indicates that this is a stricken vessel (the vessel in trouble).

CARRIER....The SAR organisation providing transportation i.e RN; RAF; MCA

COMMAND SUPPORT....A Fire Brigade Officer nominated to assist the OC.

DECLARED RESPONSE....A statement of Fire Service resources currently made available to MCA.

DEFENSIVE TACTICS...crews not committed into the 'high risk' area

EVACUATION SIGNAL...the Fire Brigade emergency evacuation signal is repeated blasts on an 'Acme Thunderer' whistle.

EMBARKATION OFFICER...A Fire Brigade Officer nominated to monitor embarkation details of personnel and equipment being conveyed offshore

INCIDENT COMMANDER (FIRE)....Senior Fire Brigade officer (*shorebased*) in overall command of the incident

MCA....Maritime and Coastguard Agency (inc. Coastguard)

MRC....Maritime Rescue Centre

MRCC...Maritime Rescue Coordination Centre

OPERATIONS COMMANDER (OC)....The Senior Fire Brigade Officer onboard the casualty.

OFFENSIVE TACTICS...Crews committed into the 'high risk' area, carry out rescues etc.

RESCUE CO-ORDINATION CENTRE (RCC)....Air operations coordinated from RAF Kinloss,

SAR FACILITY....Any unit, command, device or system used for SAR operations

SEARCH AND RESCUE (SAR)....The employment of available personnel and facilities in rendering aid to persons in distress.

SOSREP... Secretary of State's Representative

Thanks is extended in particular to Cornwall, Hampshire and Kent Fire Brigade's who provided considerable information in the research and production of this document.